

図 版

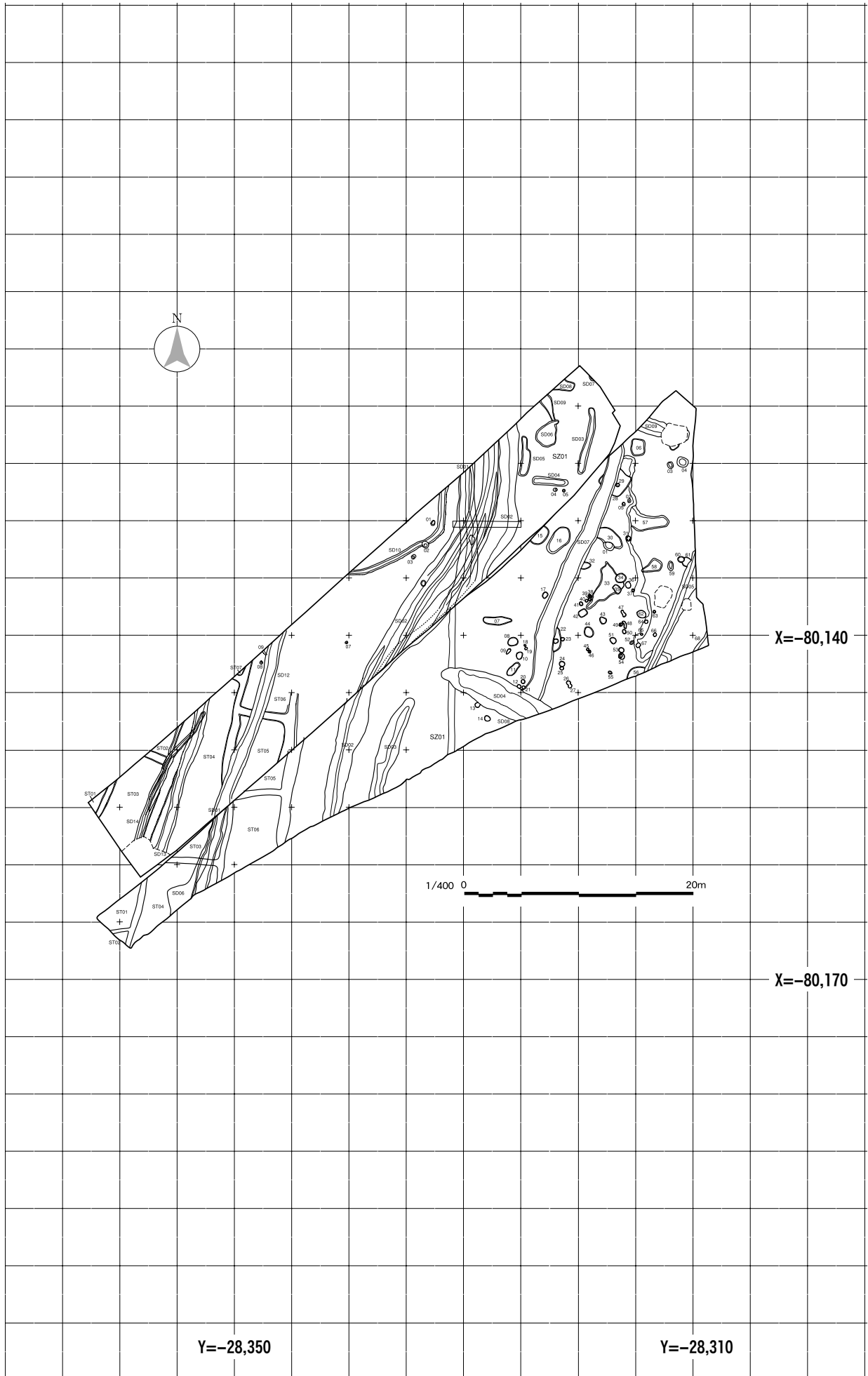

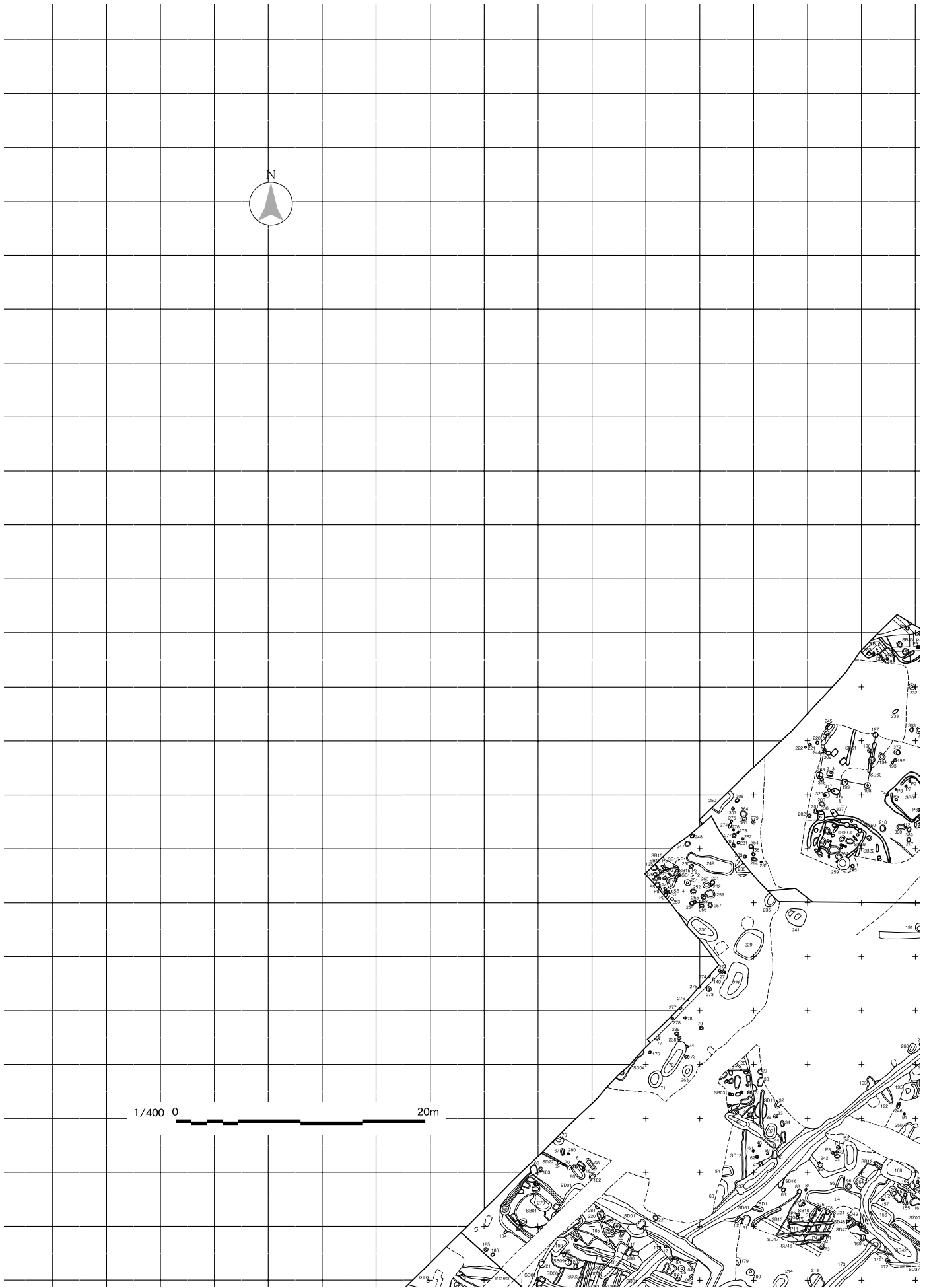

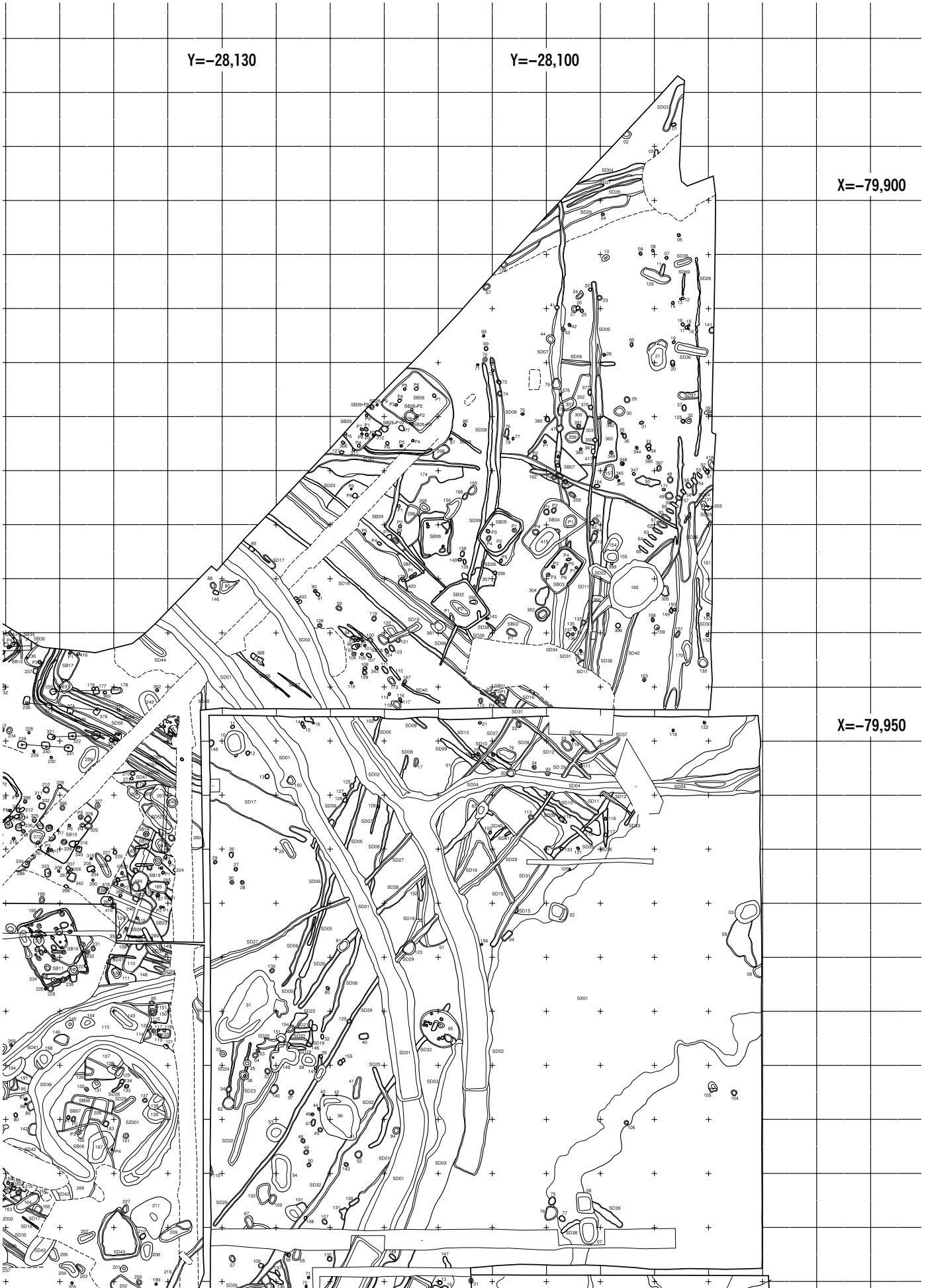



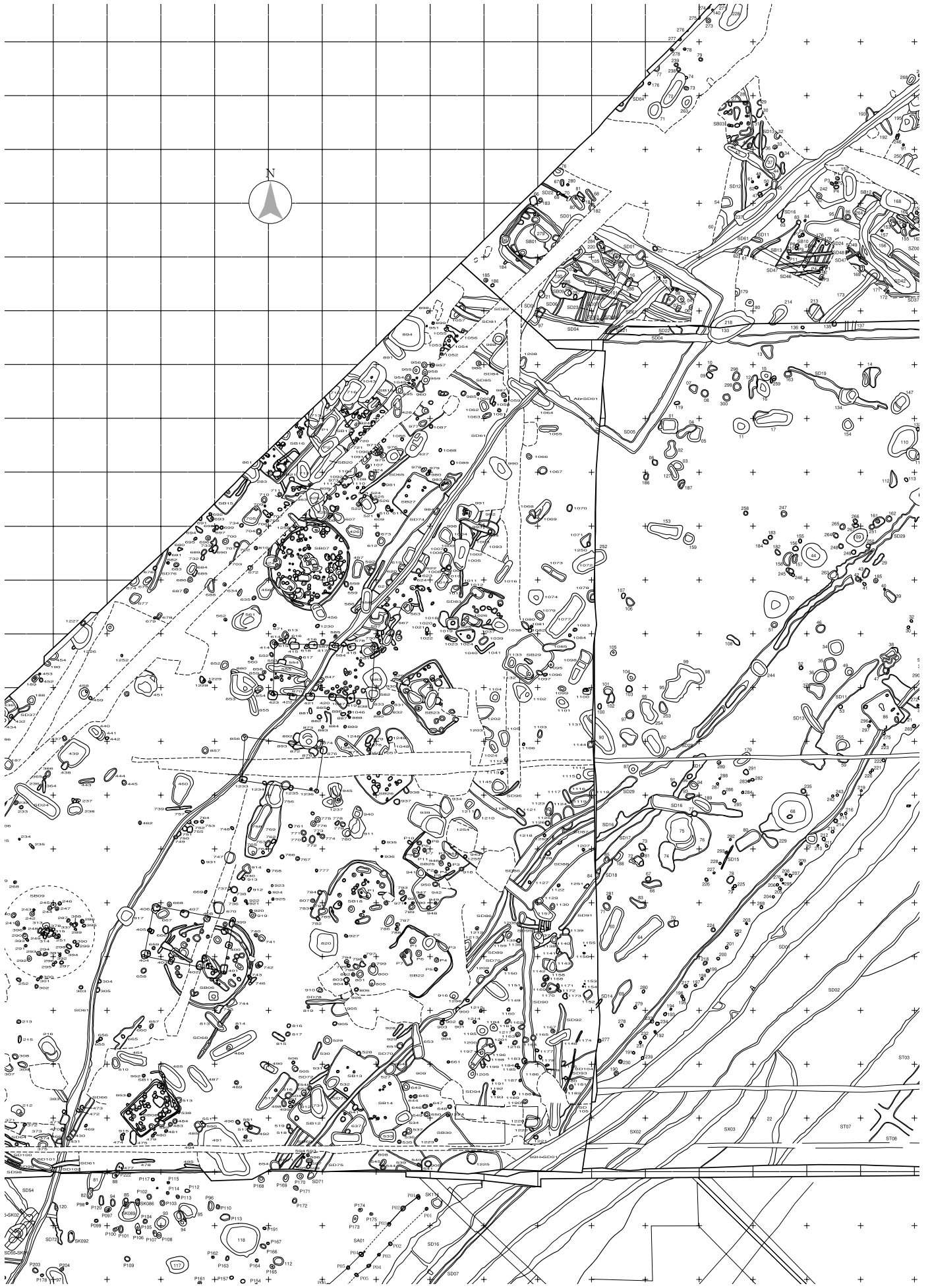

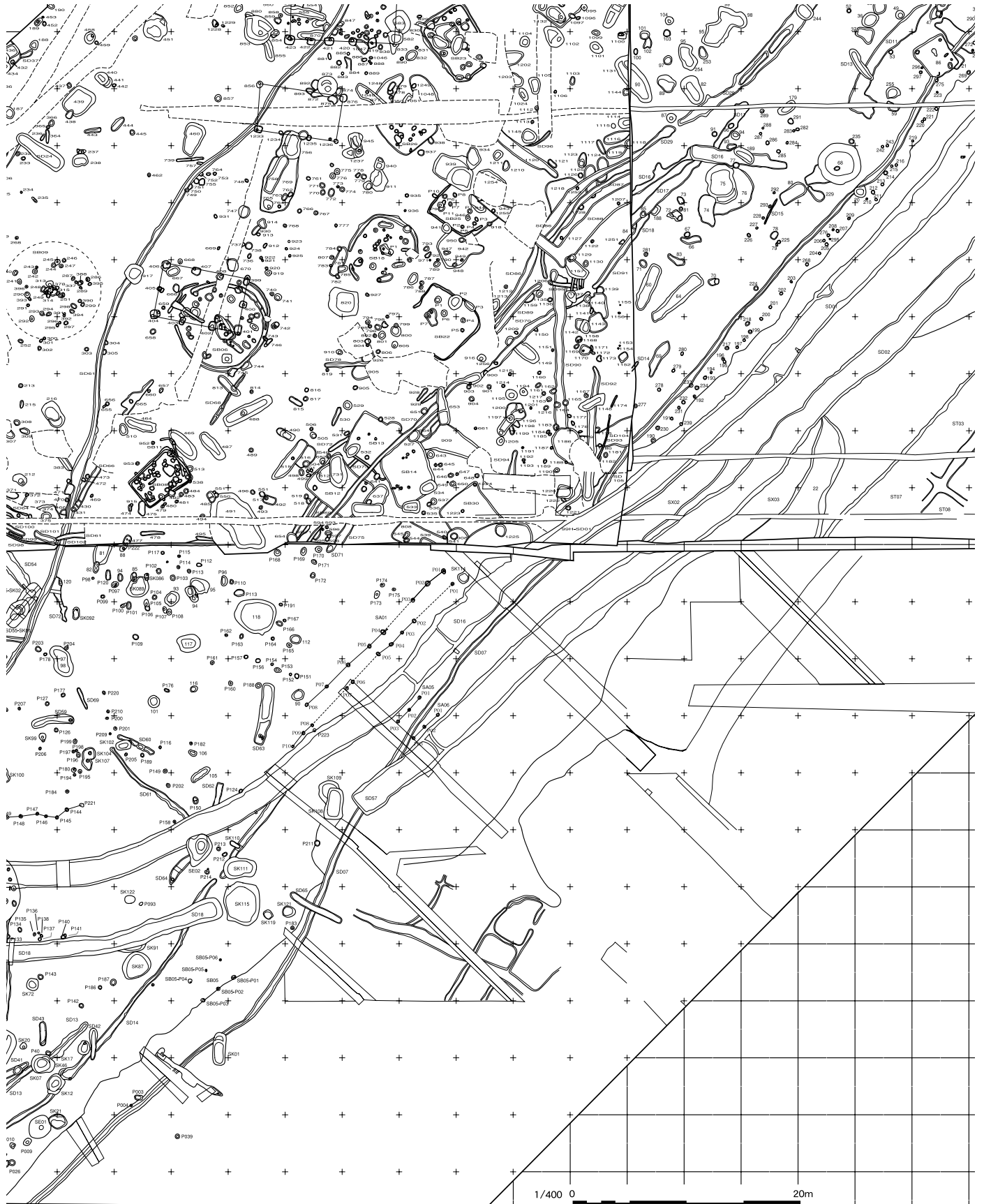

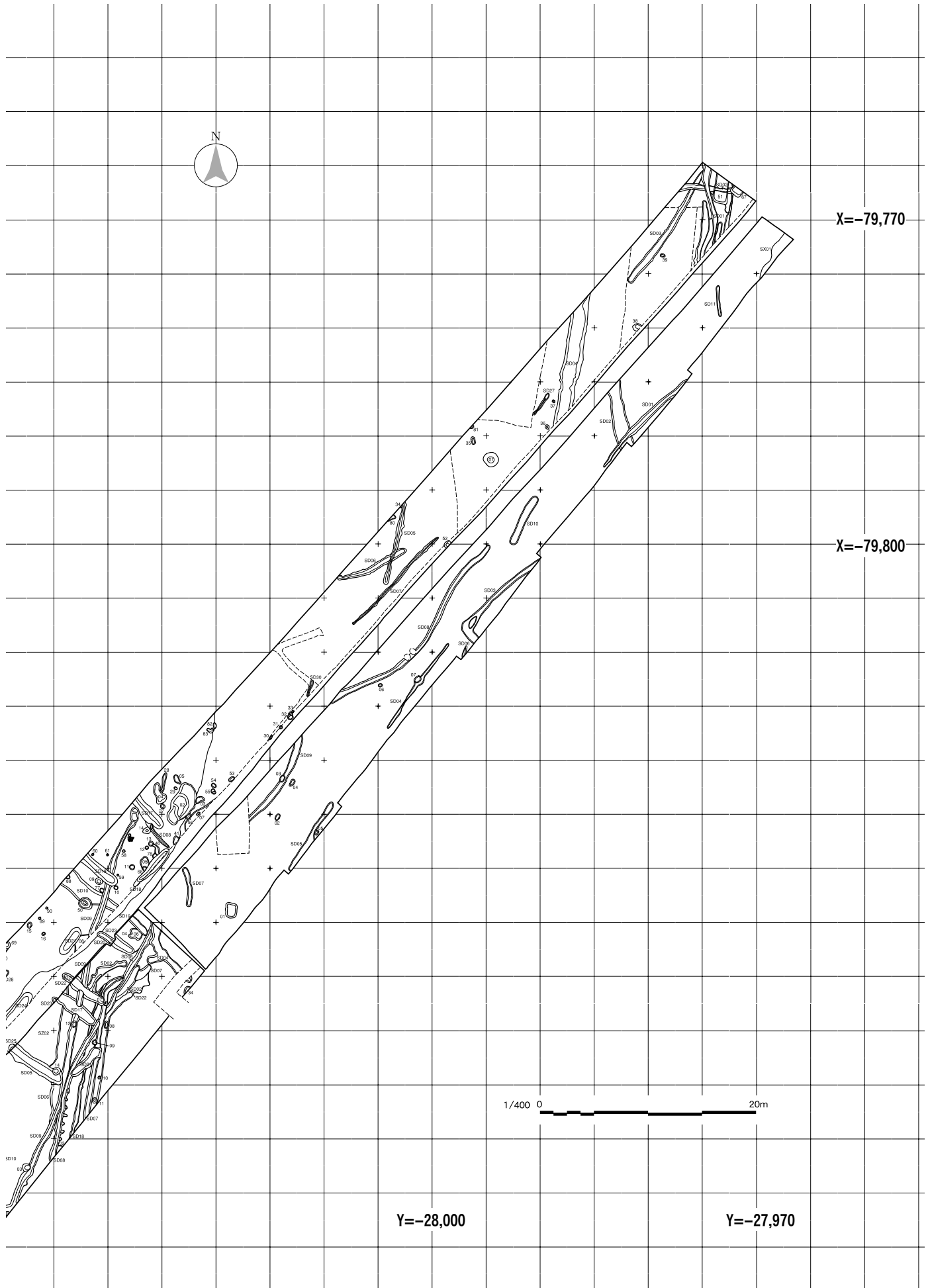

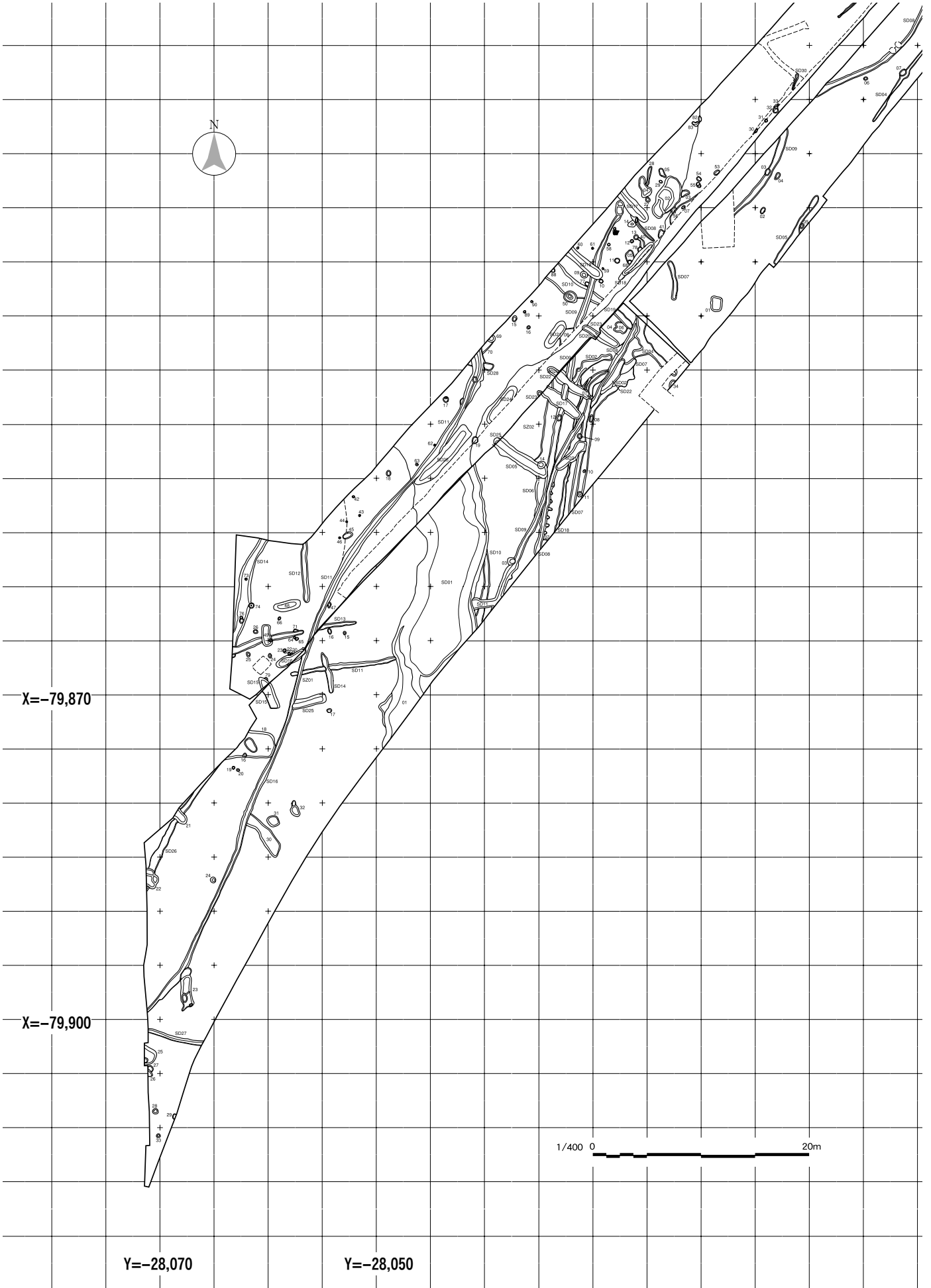

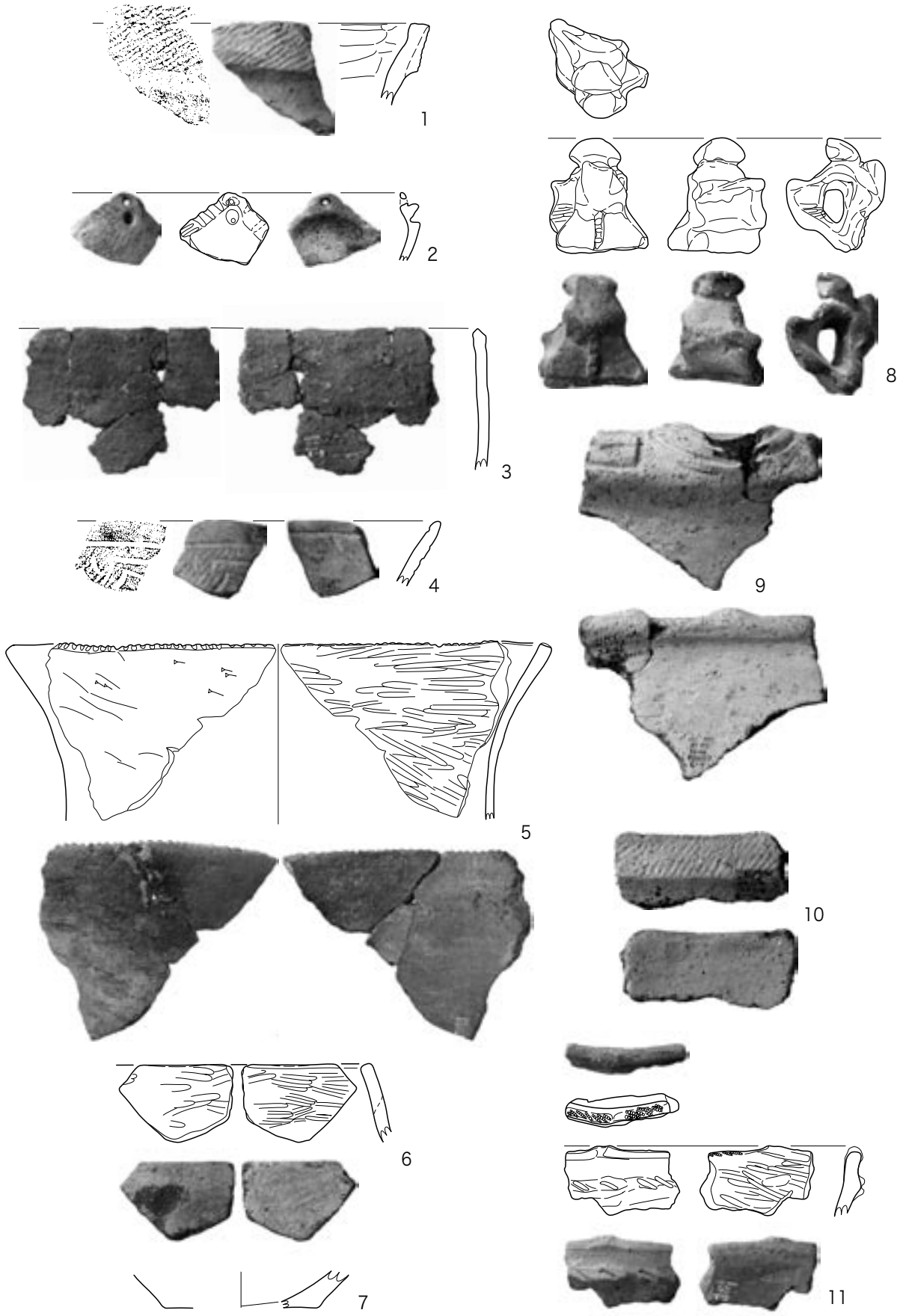

1/2 0 10cm

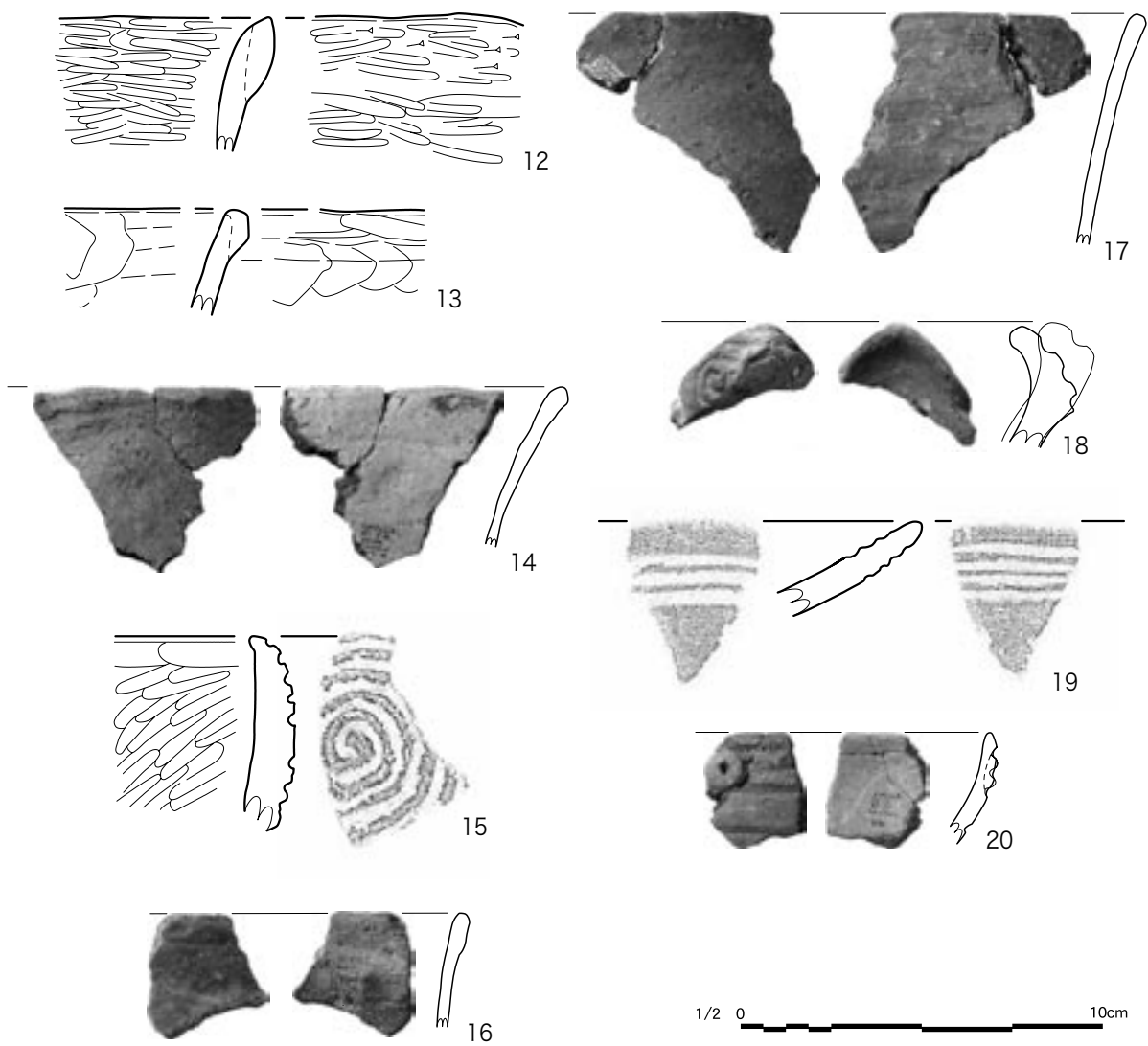

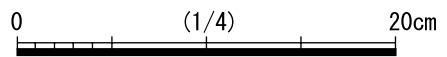
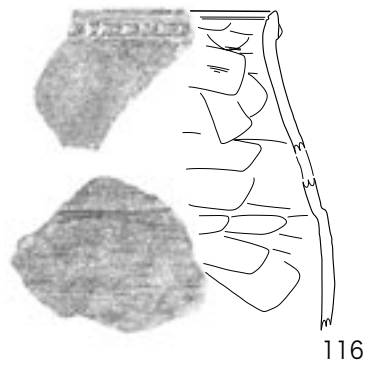
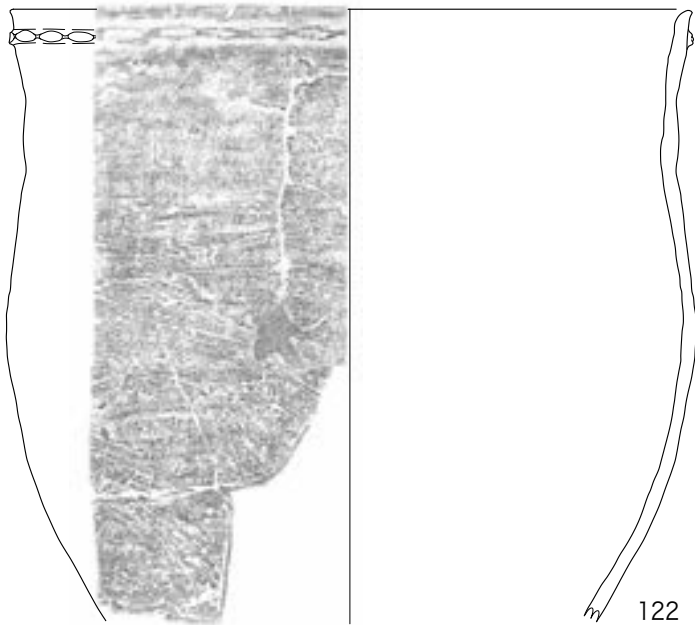
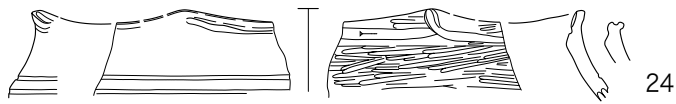
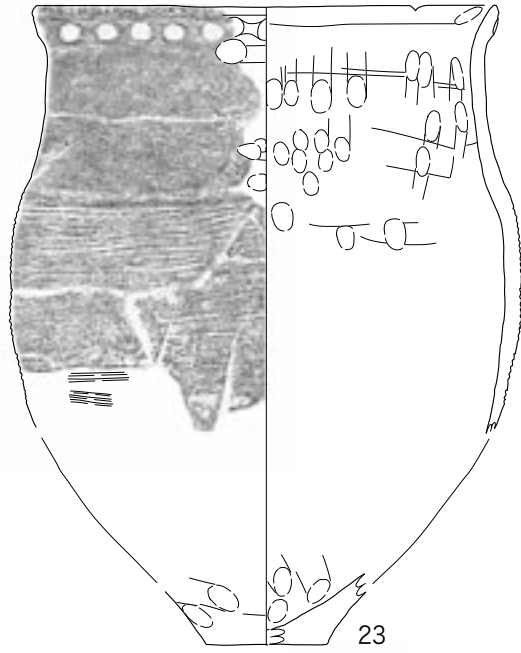
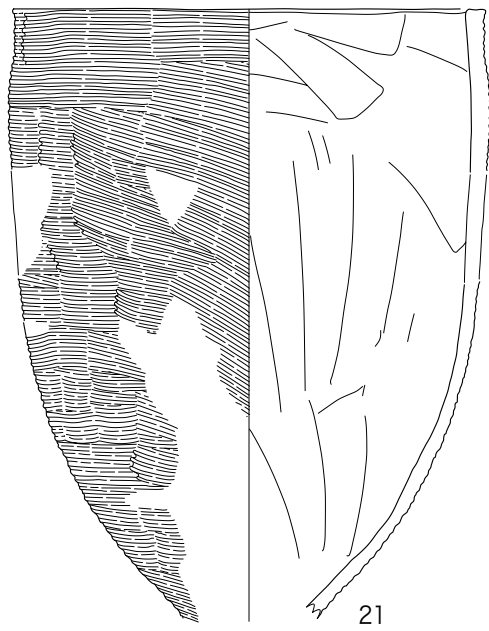

00Aa-SB01

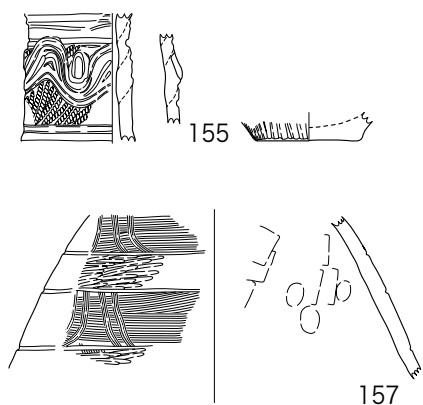

00Aa-SB02

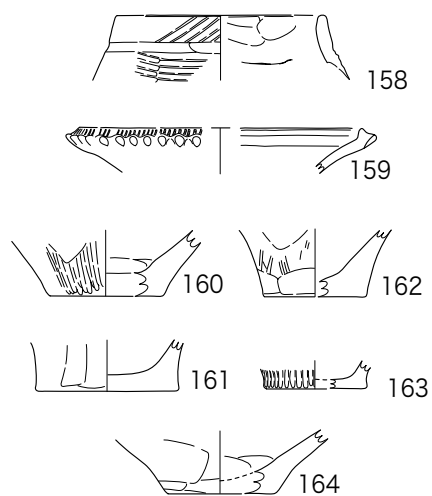

00Aa-SB06

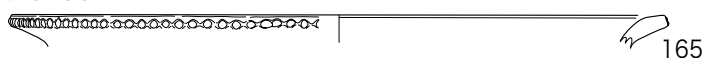

00Aa-SB07

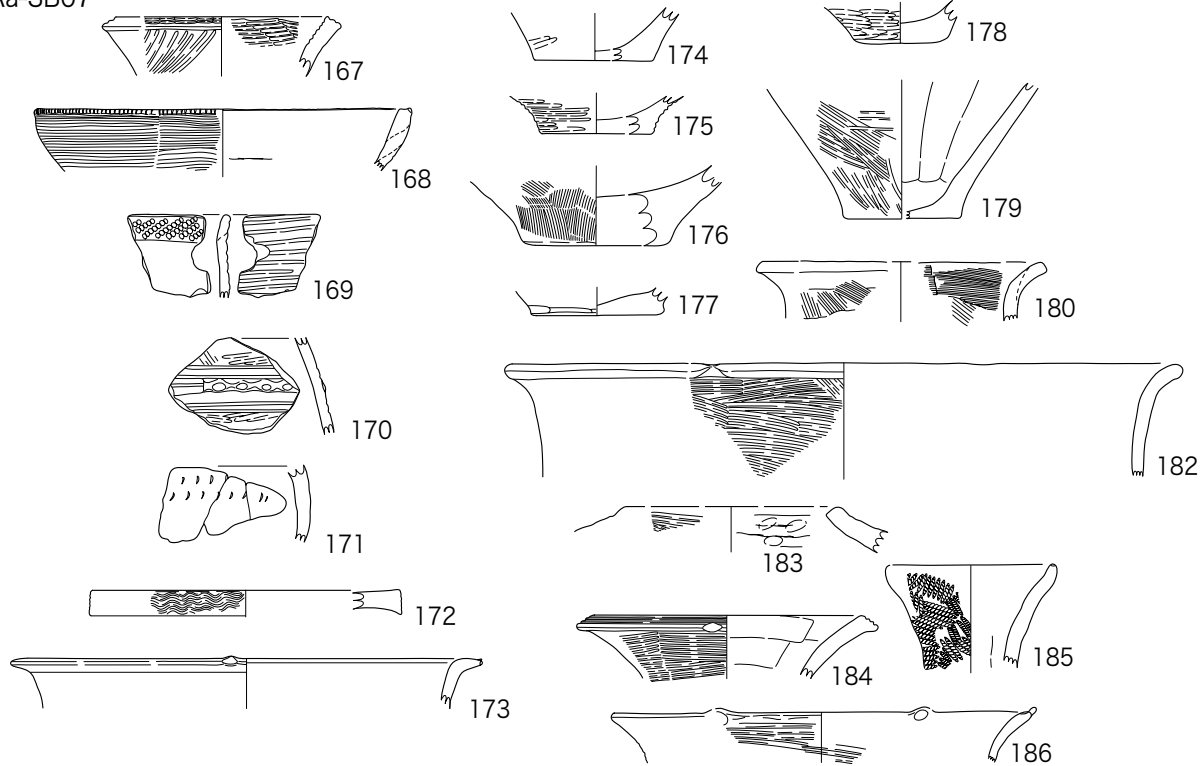

00Aa-SB08



00Aa-SB16

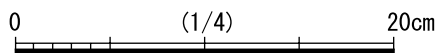
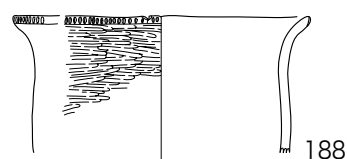
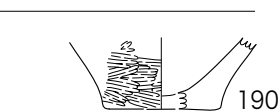
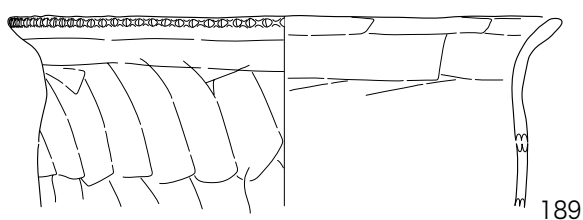

00Aa-SB17

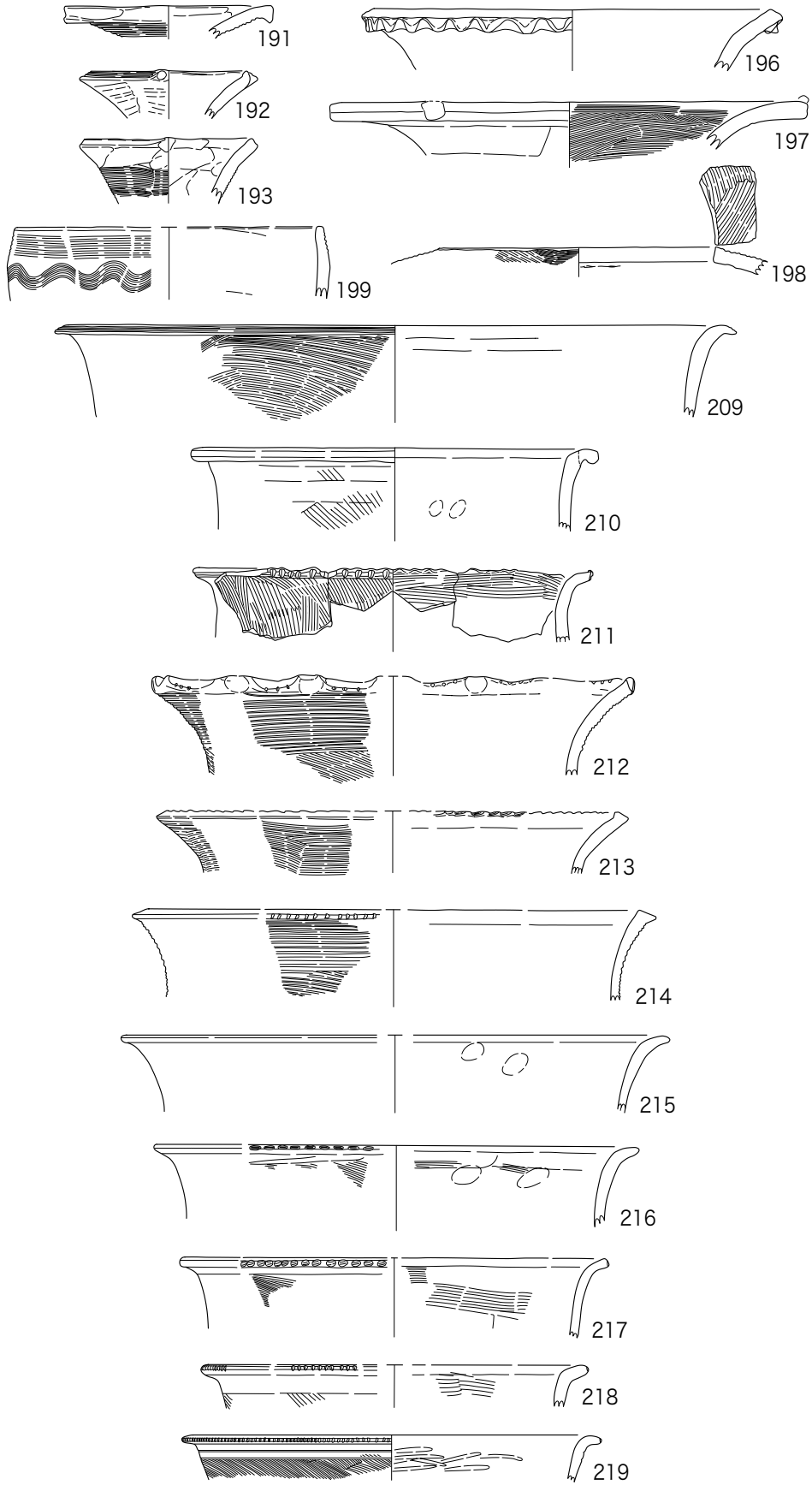

0 (1/4) 20cm

00Aa-SB17

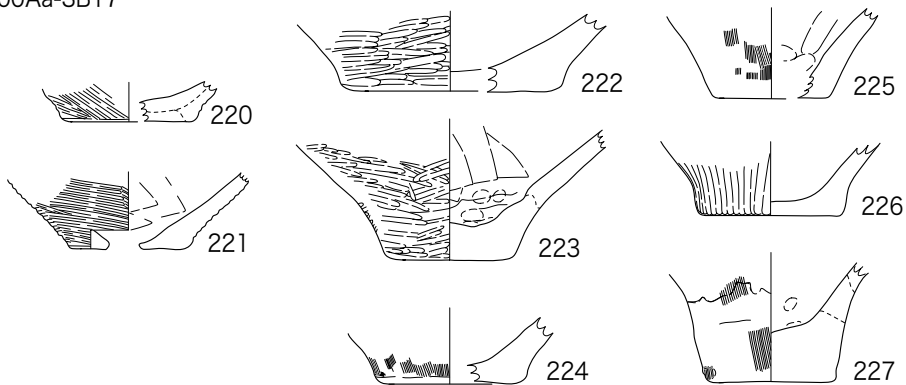

00Aa-SB17-P1

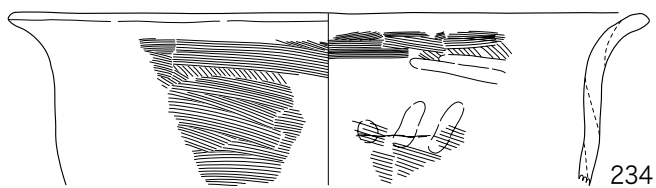
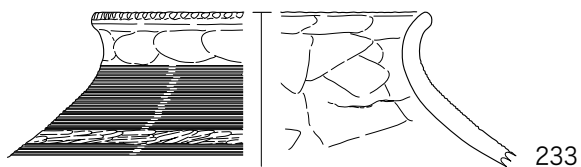
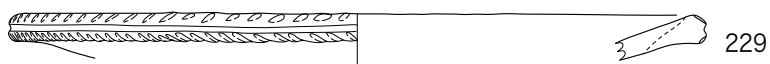
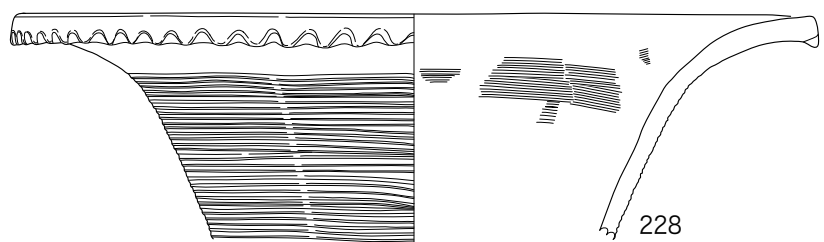

00Aa-SB17-P2

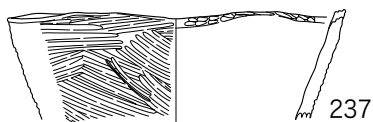

00Aa-SB17-P4

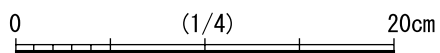
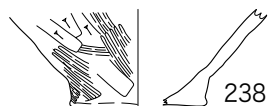
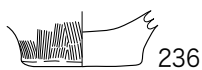
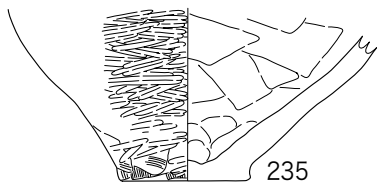
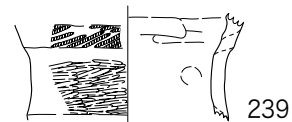

00Ab-SB01



304

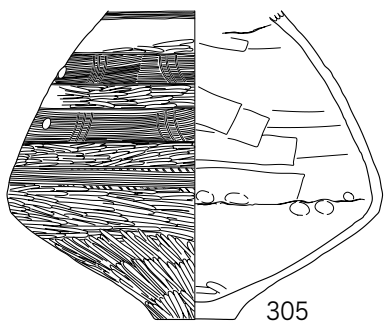

305



306



307

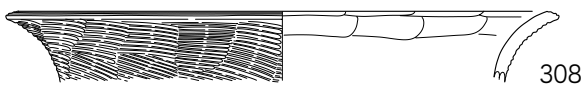

308



309

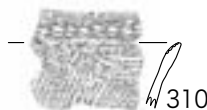

310

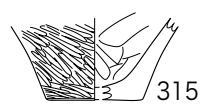

315



311

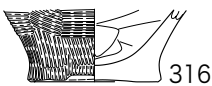

316



312

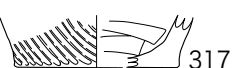

317

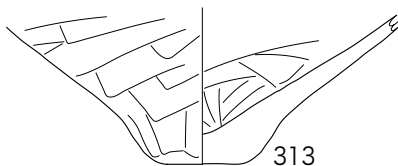

313

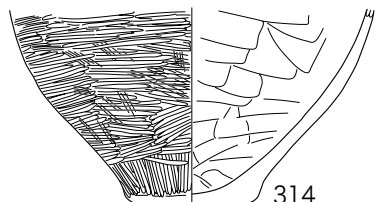

314

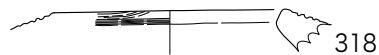

318

00Ab-SB14

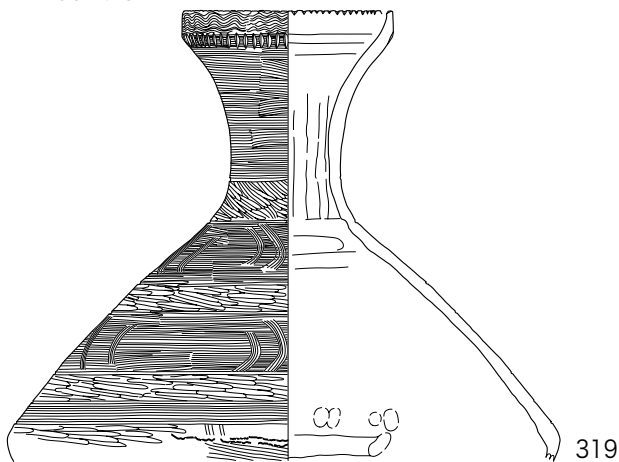

319

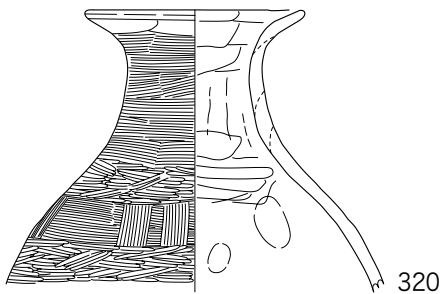

320



321



322

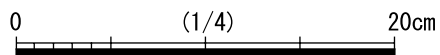

00Ac-SB03

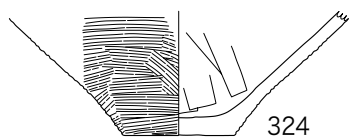
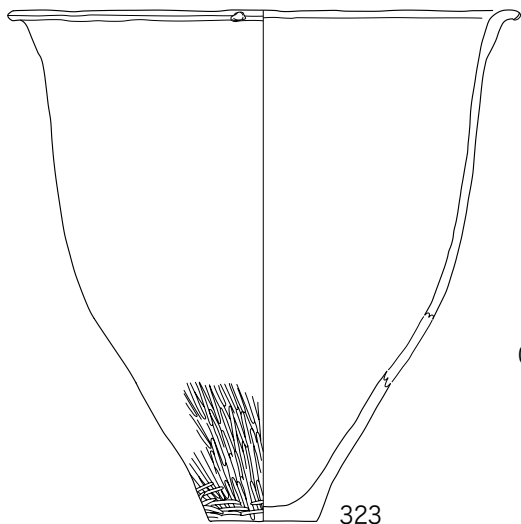

00Ac-SB06

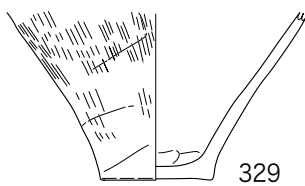

00Ac-SB09



00Ac-SB10

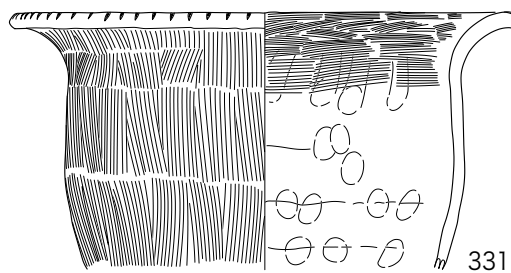

00Ac-SB04

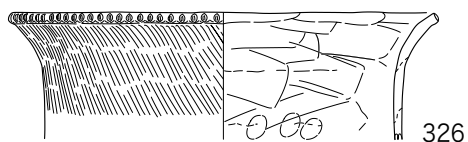
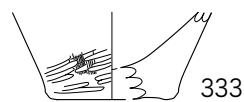
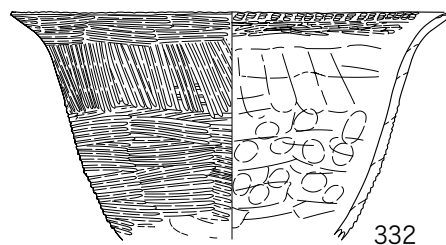
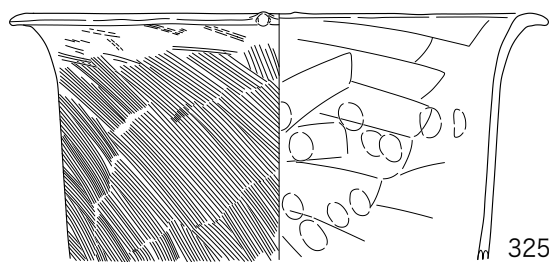

00Ac-SB12

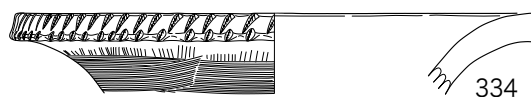

00Ac-SB06

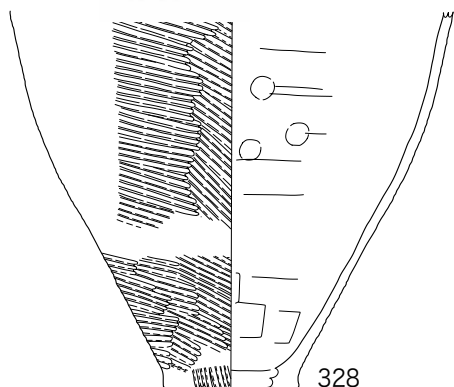
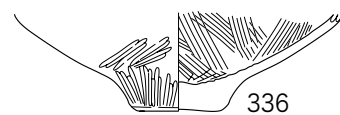
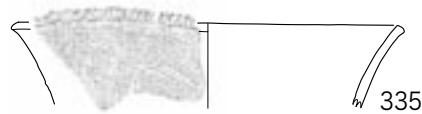

00Ac-SB19

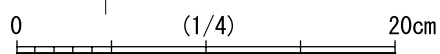
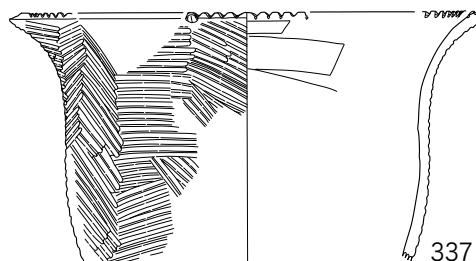

00Ac-SB15

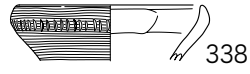

338

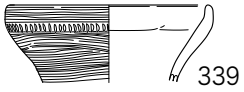

339

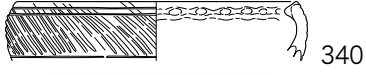

340



341

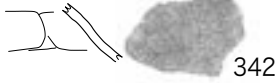

342

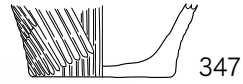
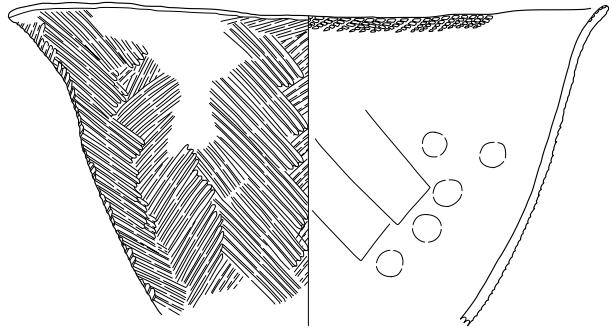

347

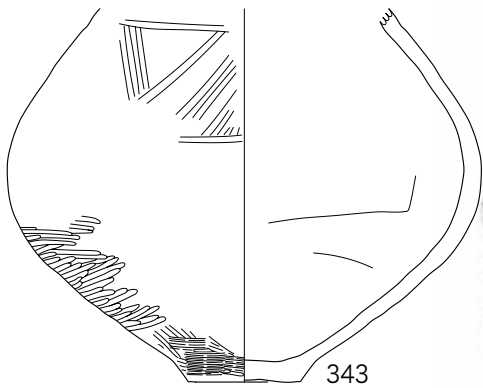

343

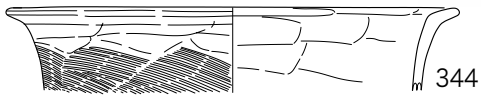

344

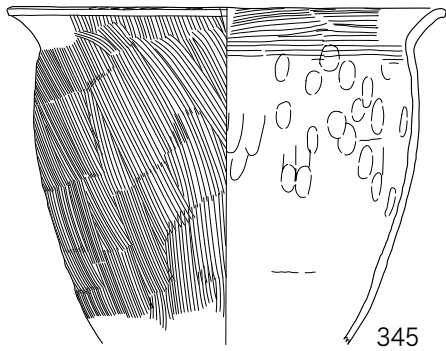

345

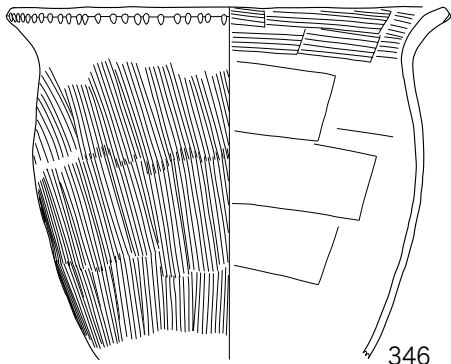

346

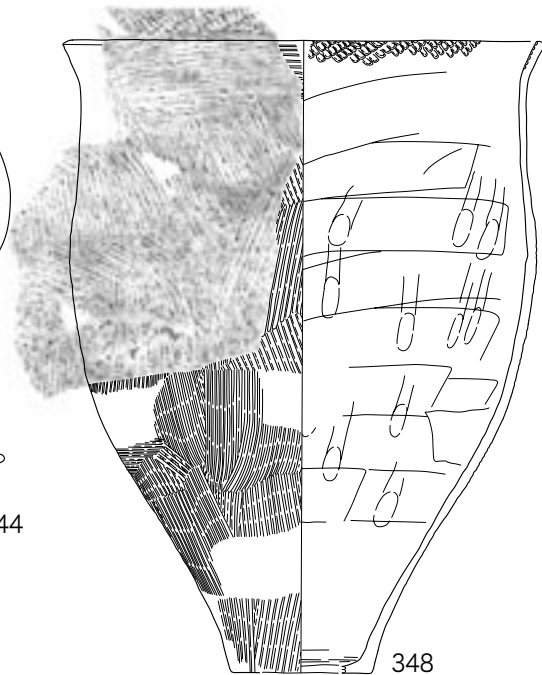

348

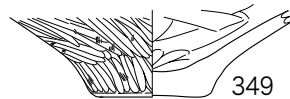

349

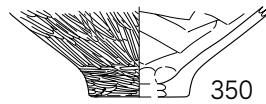

350



351

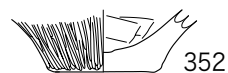

352

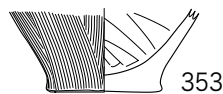

353

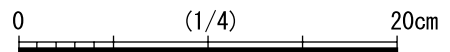

00Ac-SB21

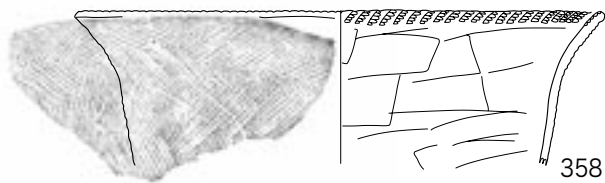
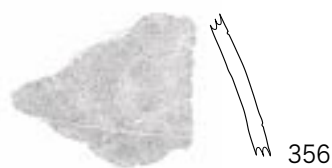
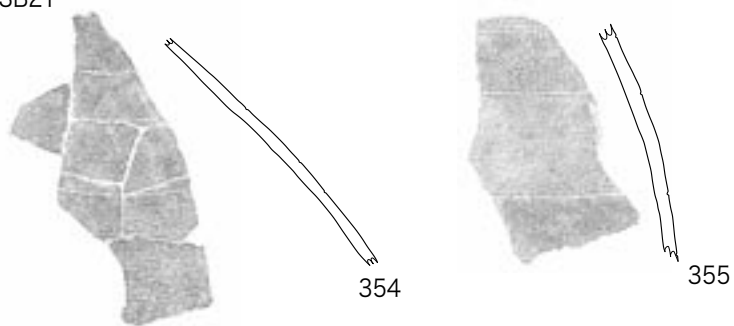

00Ac-SB31-P1

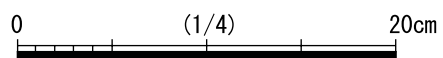
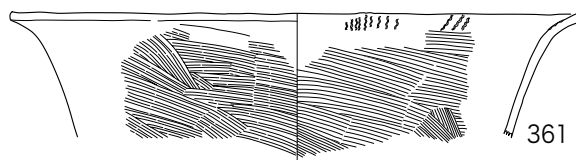

00B-SZ04-SD19

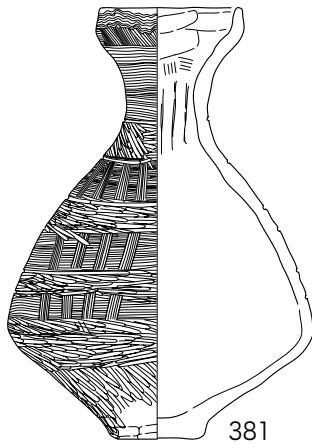

99BSZ04-SD04

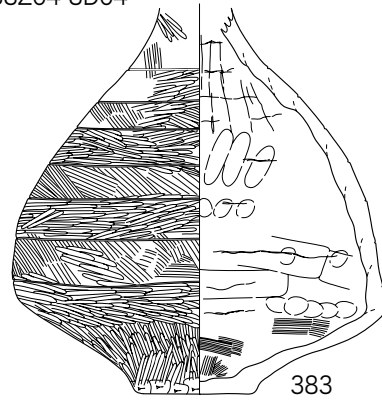

99B-SZ02-SD03

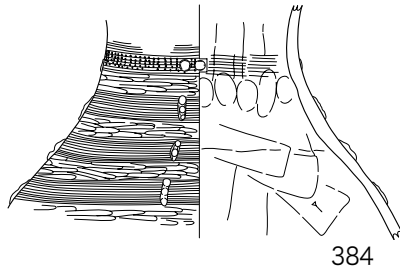
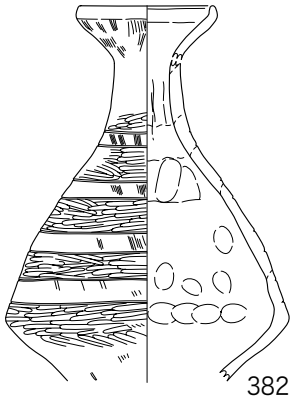

99B-SK34

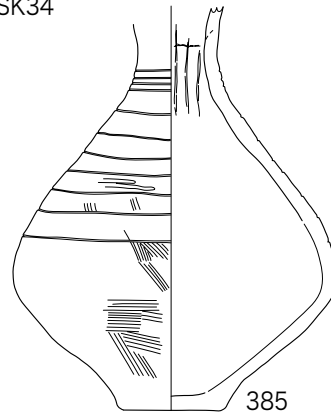

99Ca-SZ06-SD02

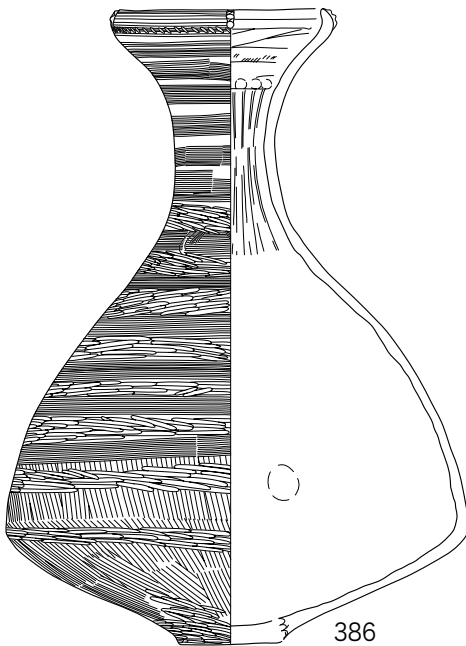

99I-SD07

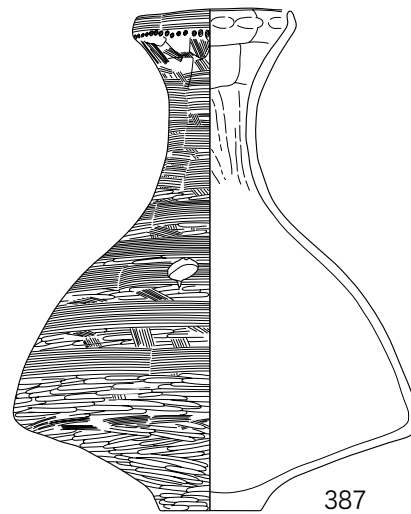

0 (1/4) 20cm

99B-SK02

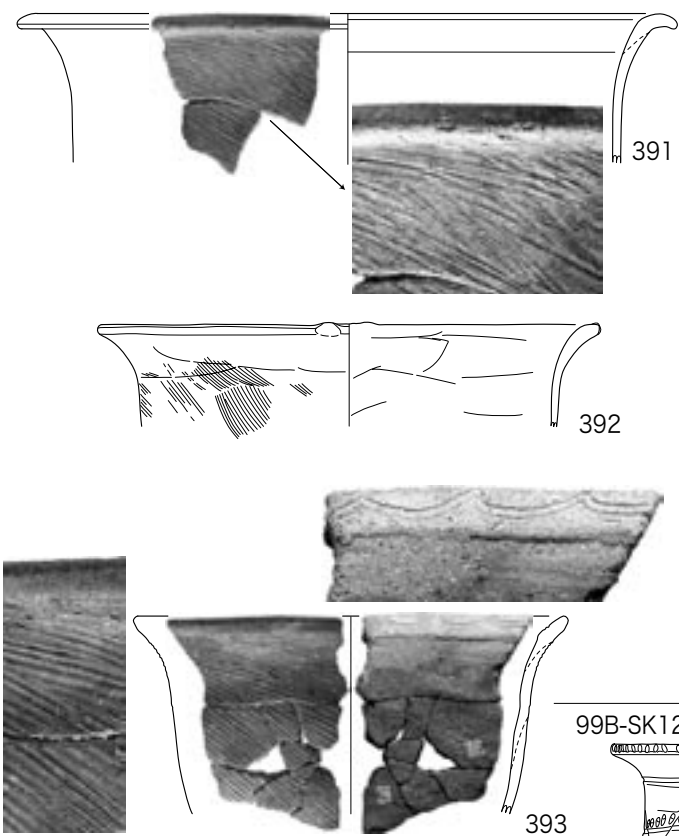

99B-SK13

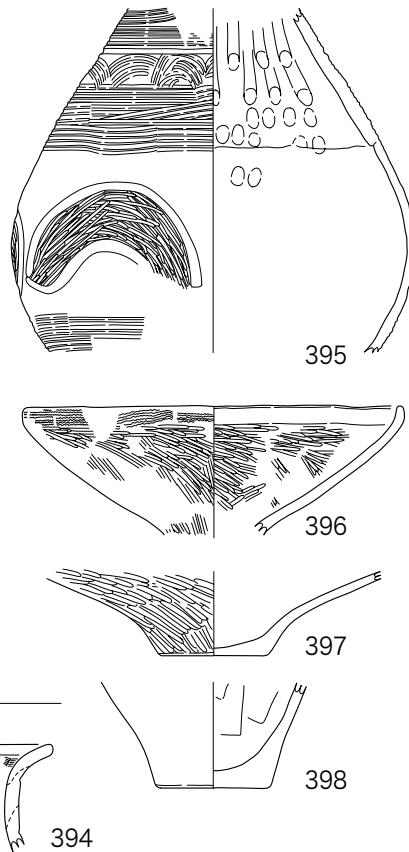

99B-SK12

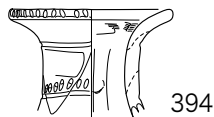

99B-SK16

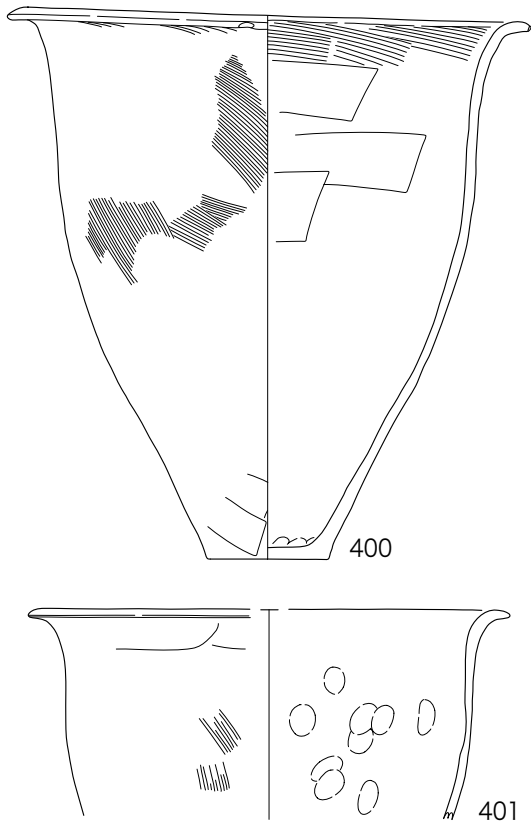

399



403

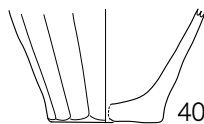

99B-SK37

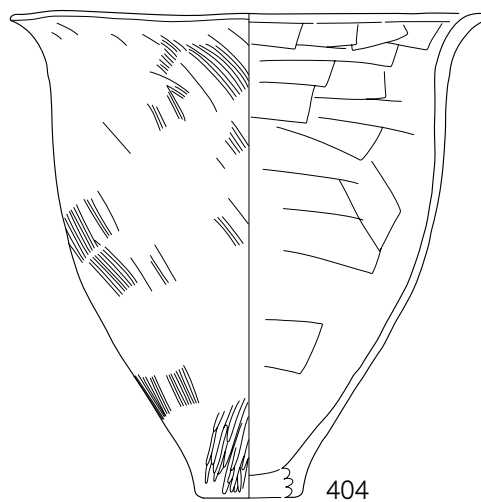

0 (1/4) 20cm

99B-SK14

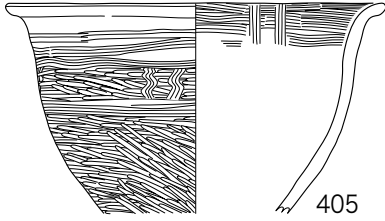

99B-SK36

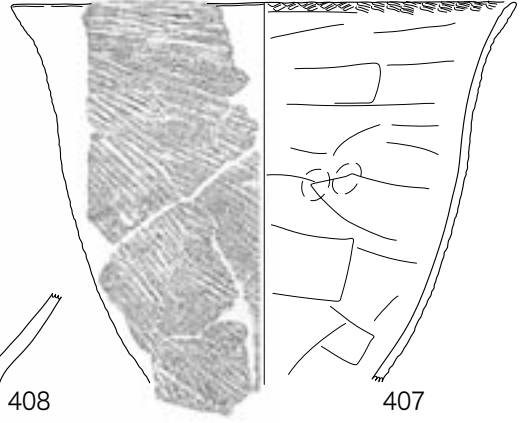

99B-SK34

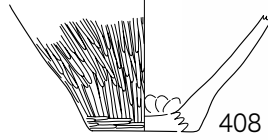
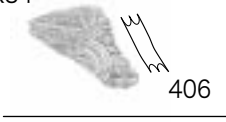

99Ca-SK41

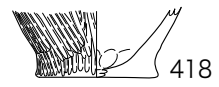
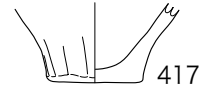
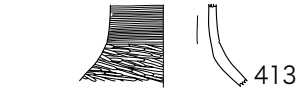
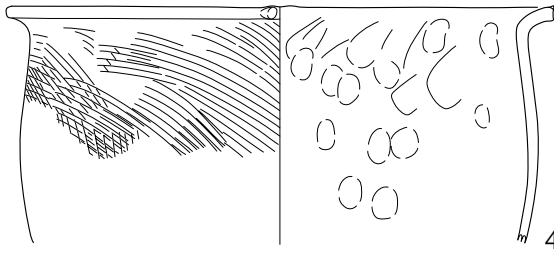
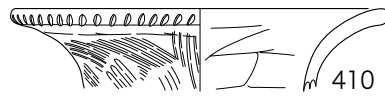
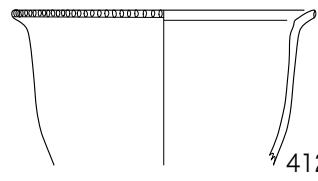
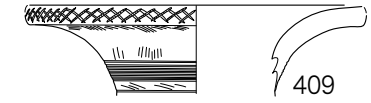

99Ca-SK43

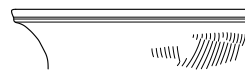
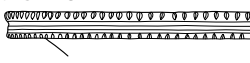

99Ca-SK42

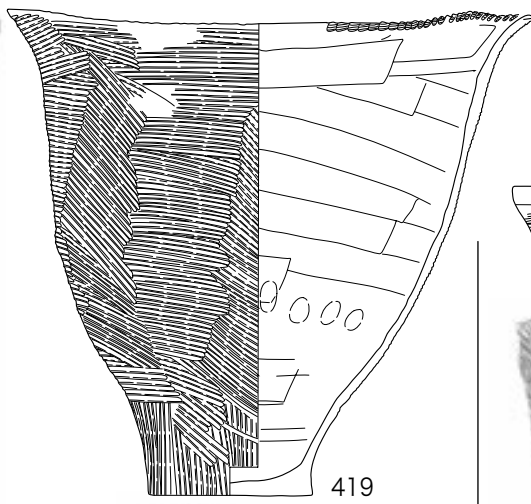

99Ca-SK45

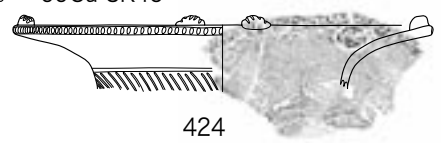

424

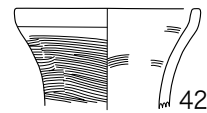

425



427

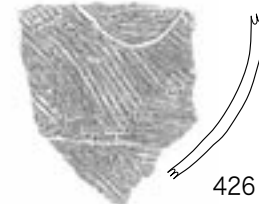

426



428

99Ca-SK61



429

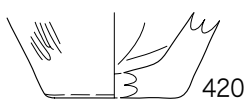

420

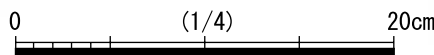

99Ca-SK44

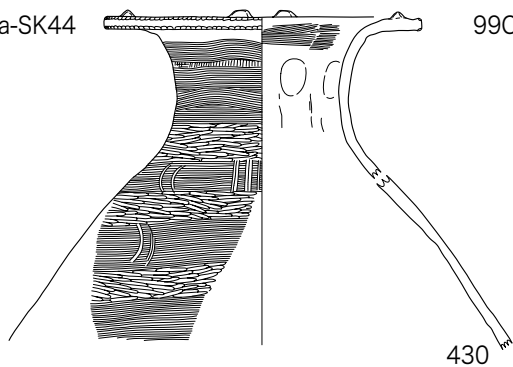

99Ca-SK51

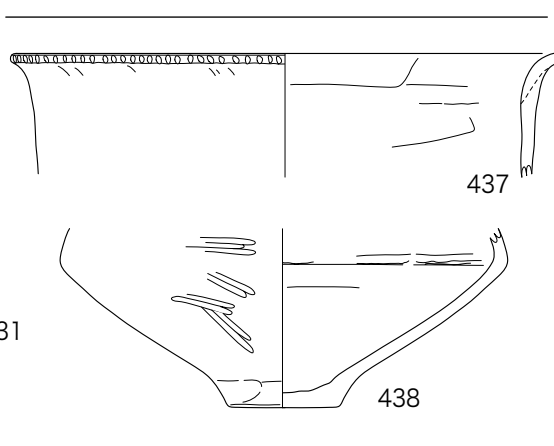
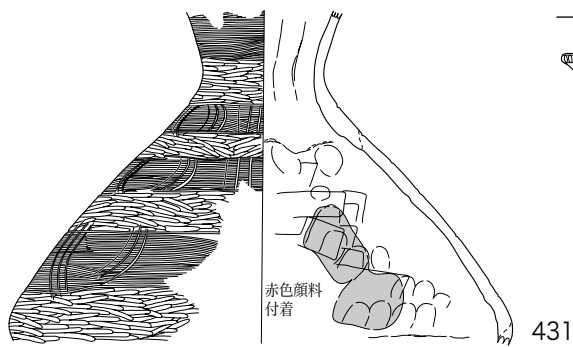
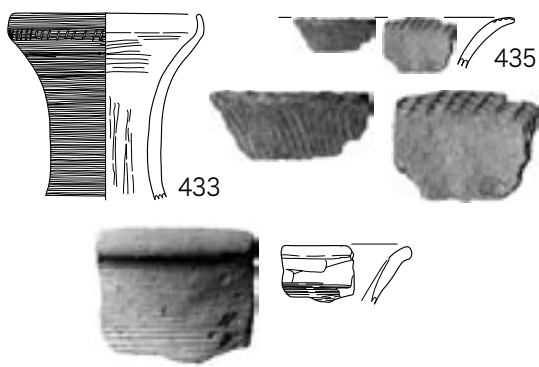

99Cb-SK80下層



99Cb-SK80下層

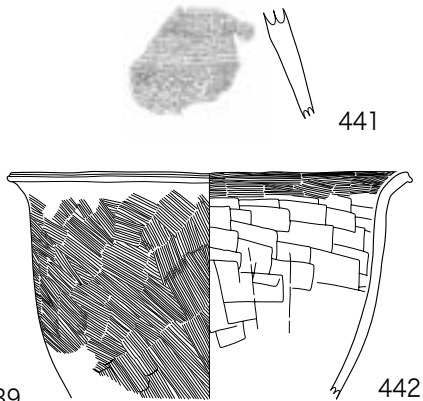
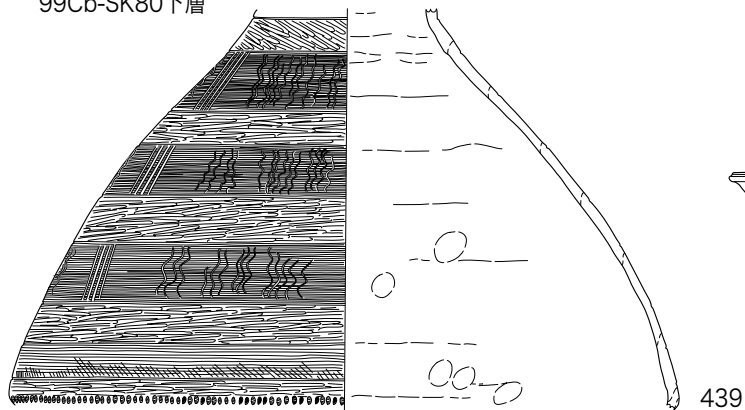

99Cb-SK94

99Cb-SK91

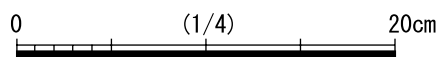
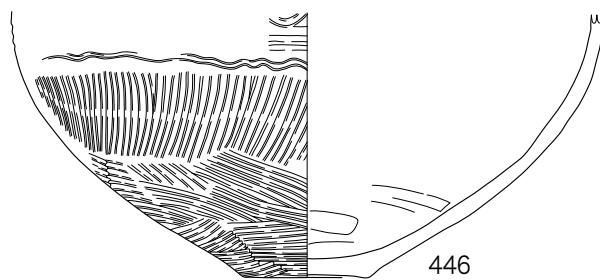
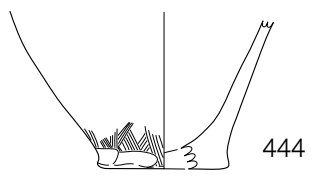

99Cc-SK74

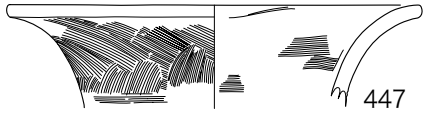

447

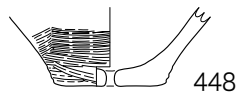

448

99E-SK83

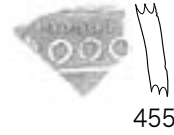

455

99E-SK01



454

99E-SK31

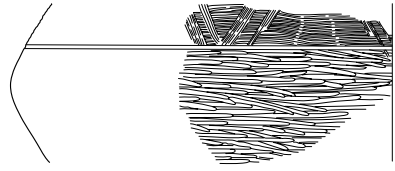

451

99E-SK61



456

450

99E-SK100下層

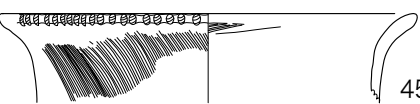

457

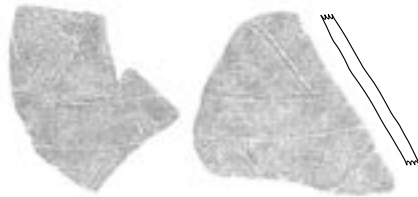

452

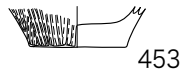

453

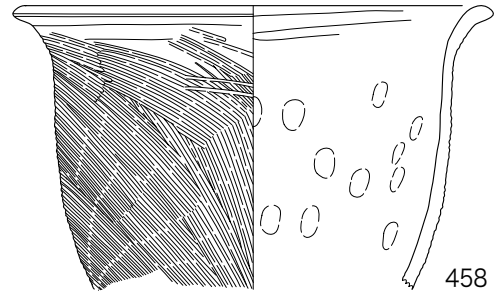

458

99H-SK17

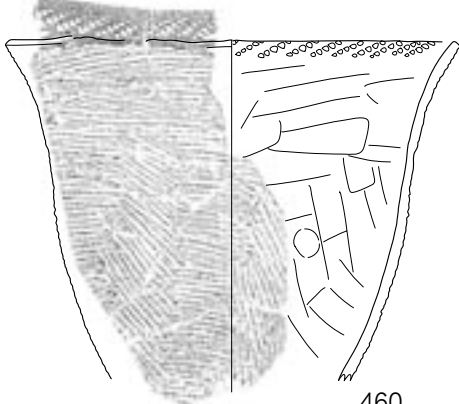

460

99H-SK37

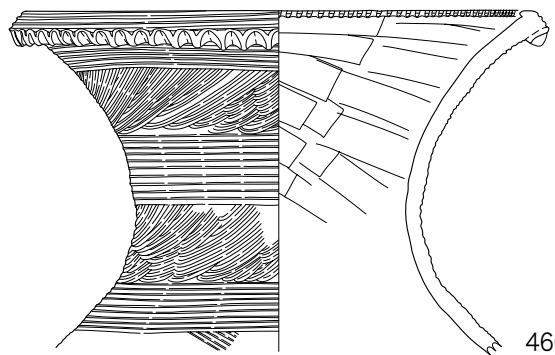

466

99H-SK19



461

99H-SK38

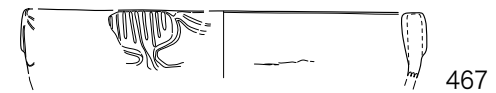

467

99H-SK22

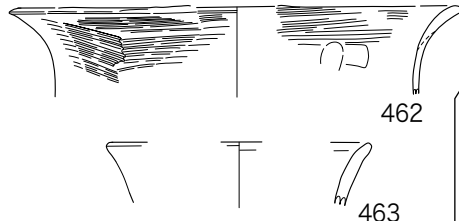

462



463

99H-SK90

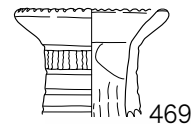

469

99H-SK64

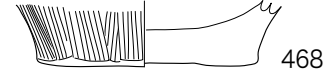

468

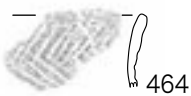

464



465



470



471

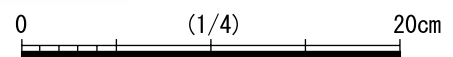

99H-SK45

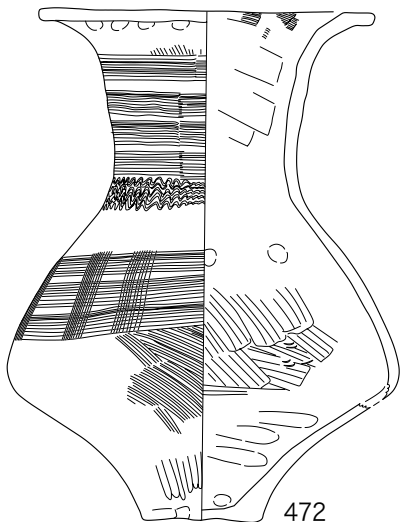

99H-SK61

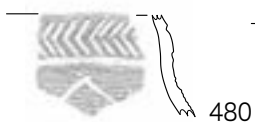
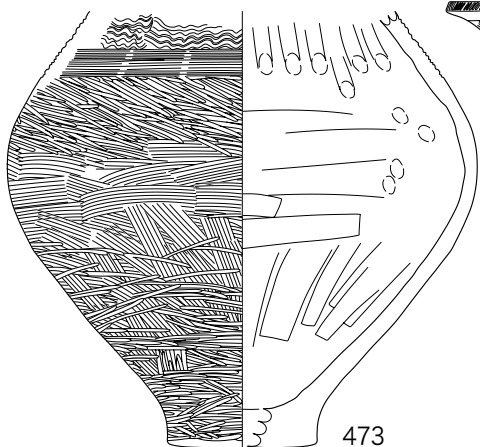
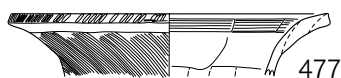
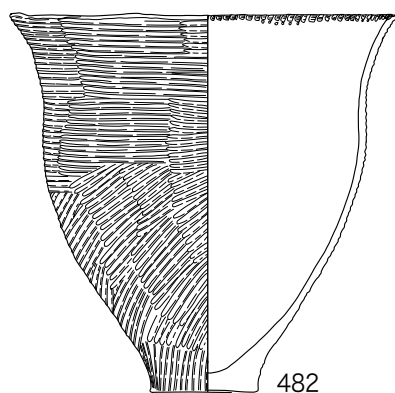
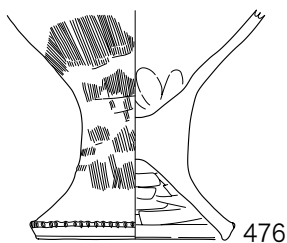
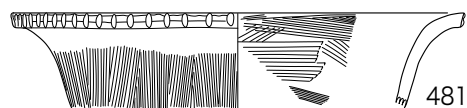
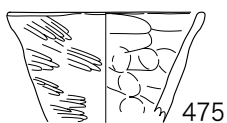

99H-SK98

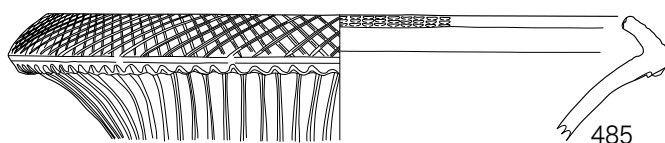

99H-SK68

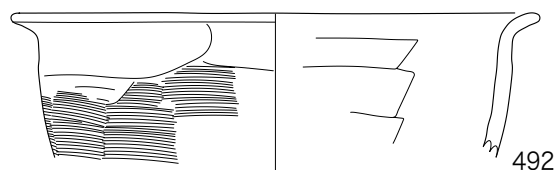

99H-SK68下層

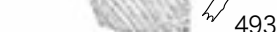
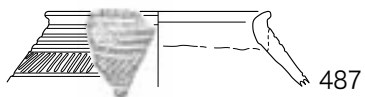

0 (1/4) 20cm

99H-SK68上層

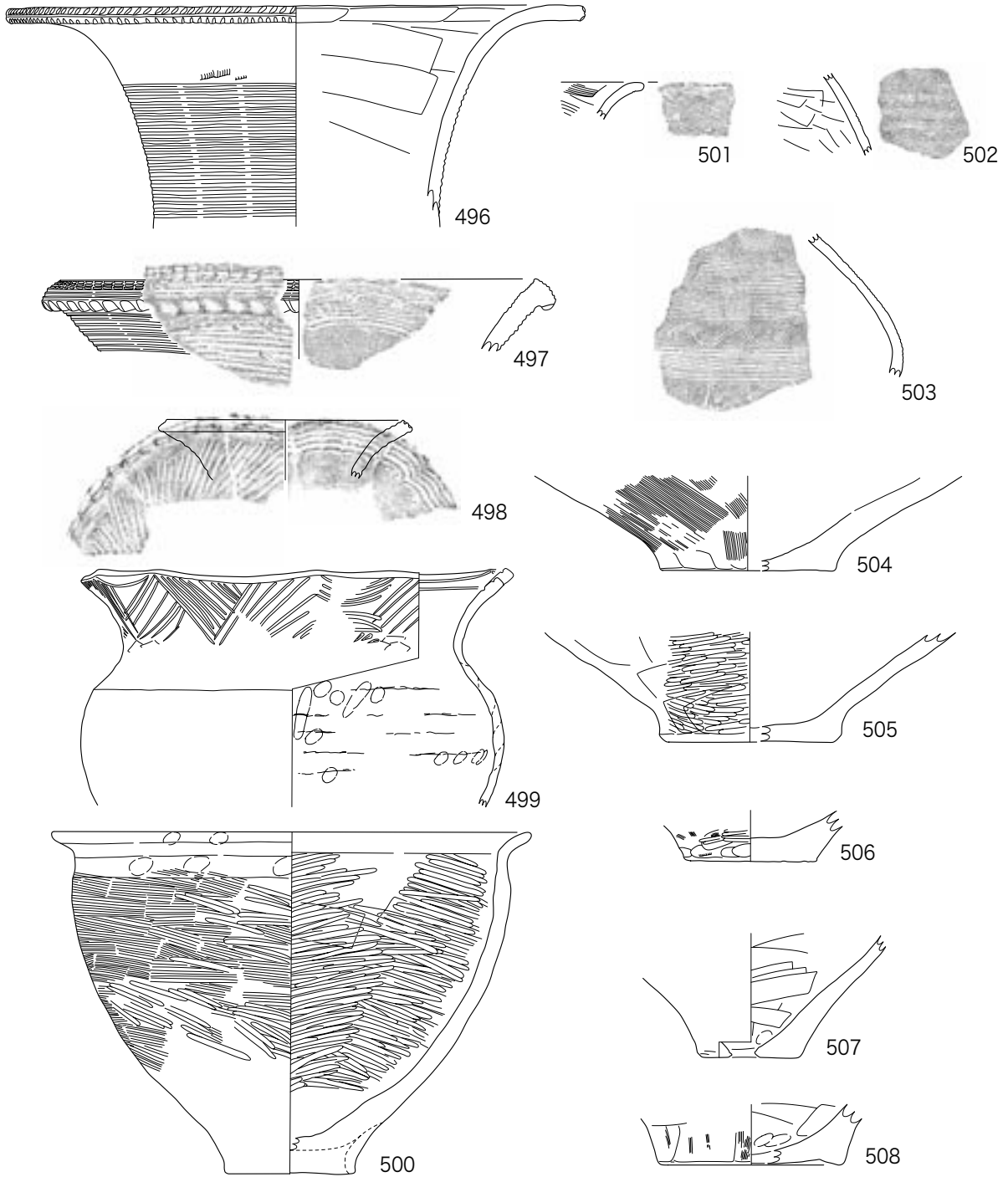

99H-SK109

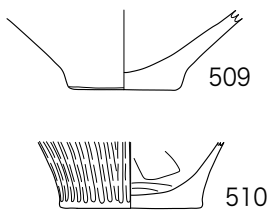

99H-SK120

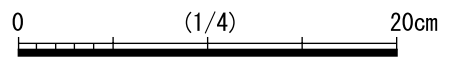
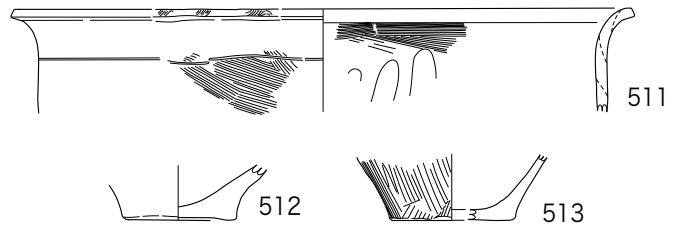

99H-SK86

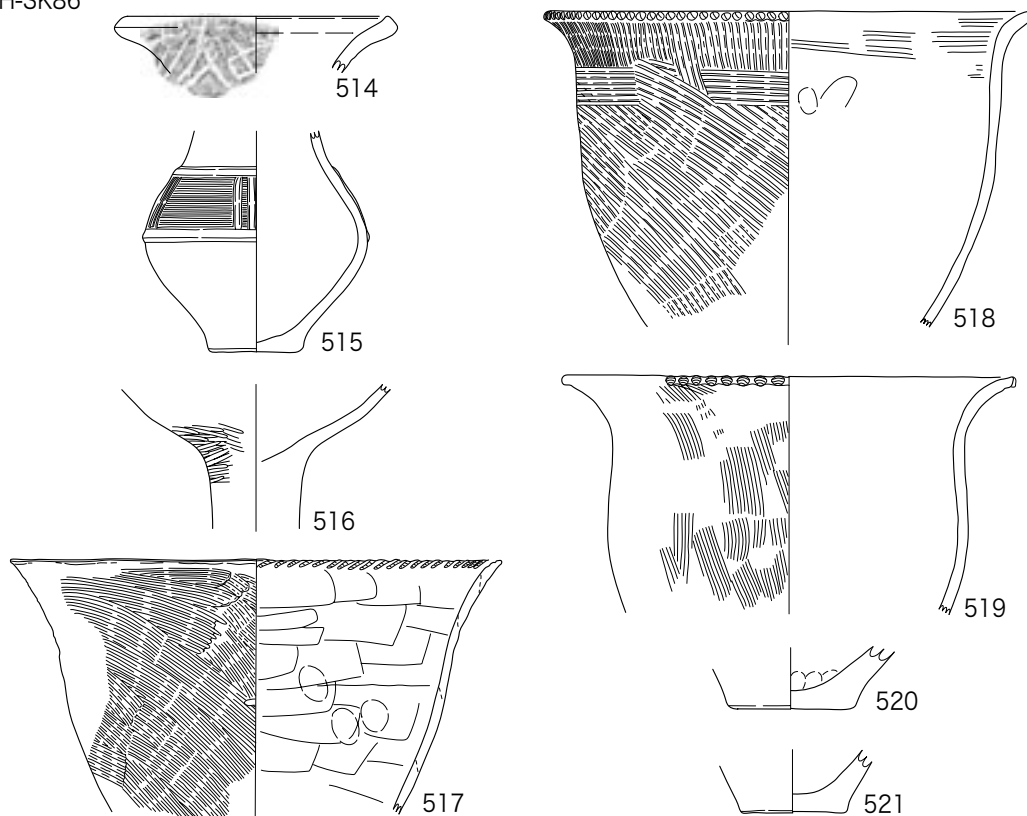

99H-SK133

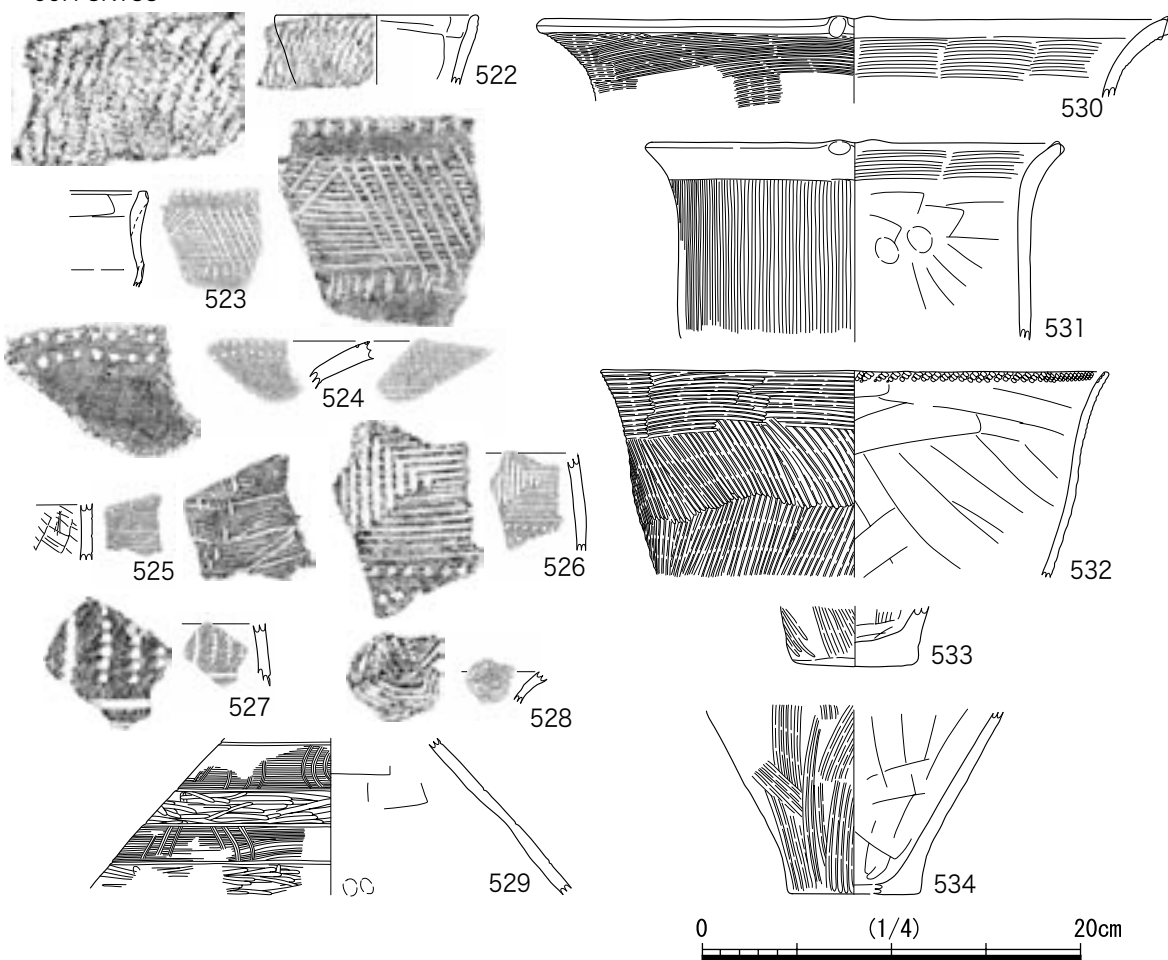

99H-SK134

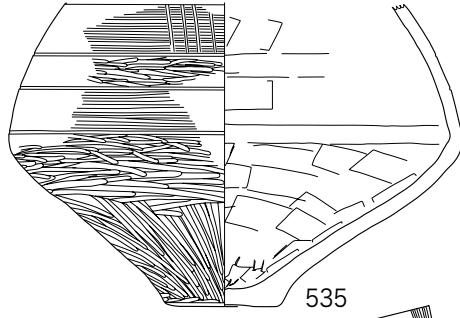

99H-SK154

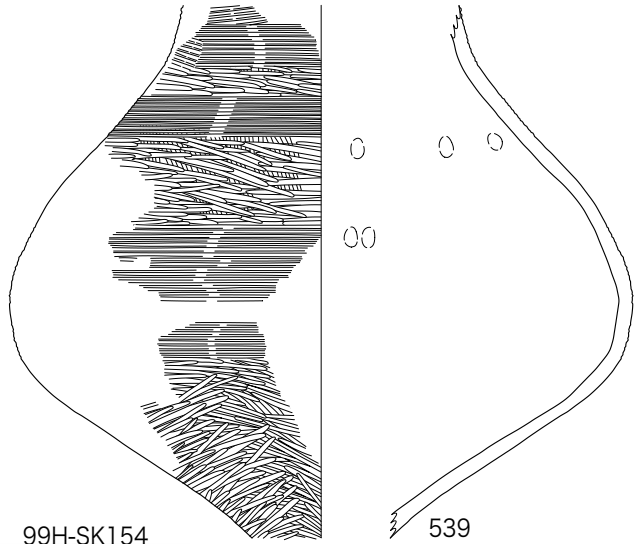

99H-SK147

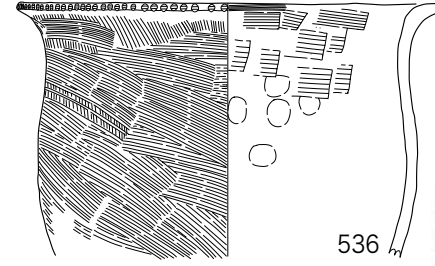

99H-SK154

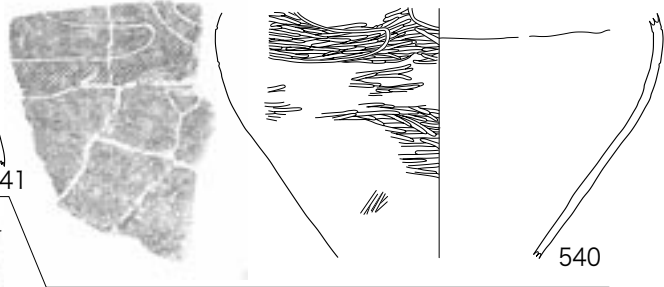

99H-SK153

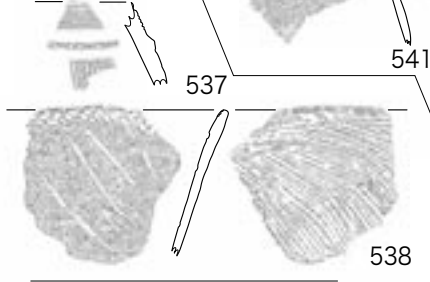

99H-SK252

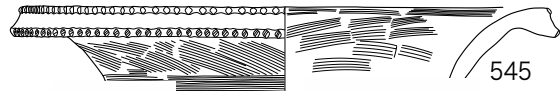

99H-SK161

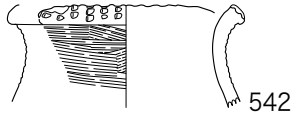

99H-SK178

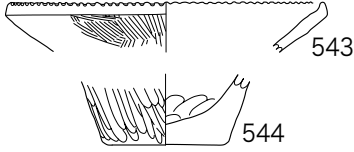

00Aa-SK147

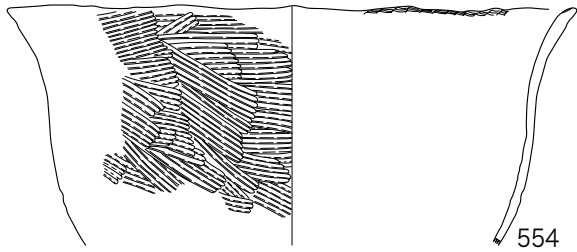

00Aa-SK70

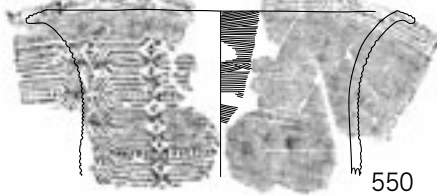

00Aa-SK155

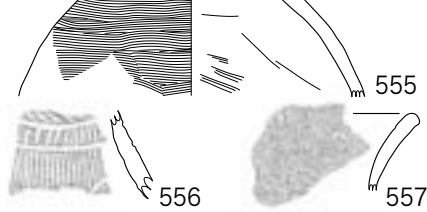

00Aa-SK121

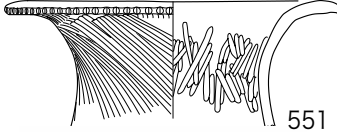

00Aa-SK162

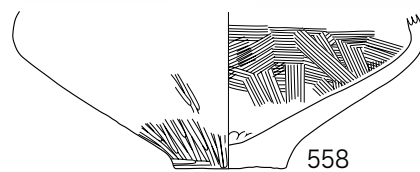

00Aa-SK132

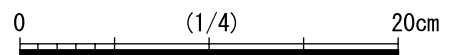

00Aa-SK126

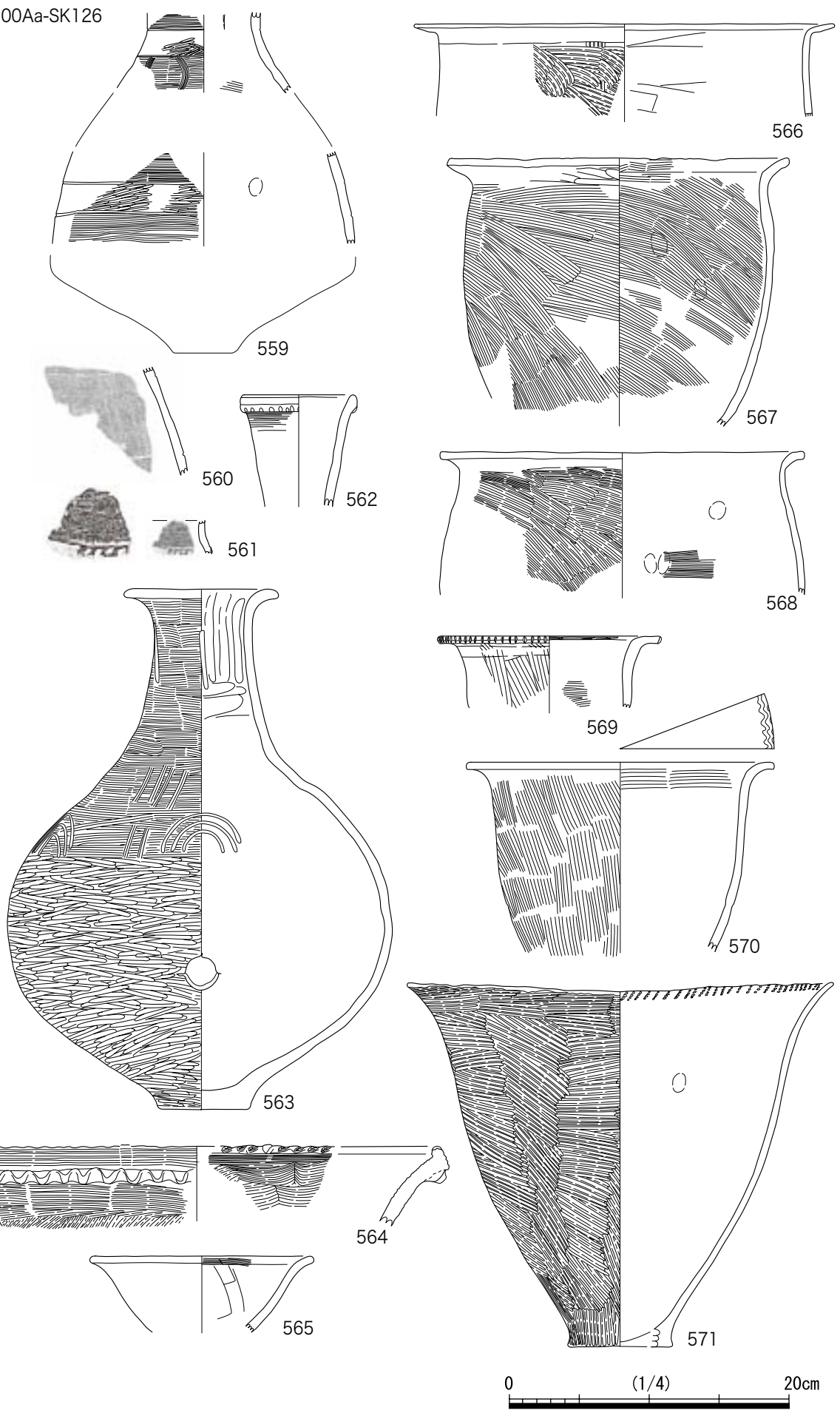

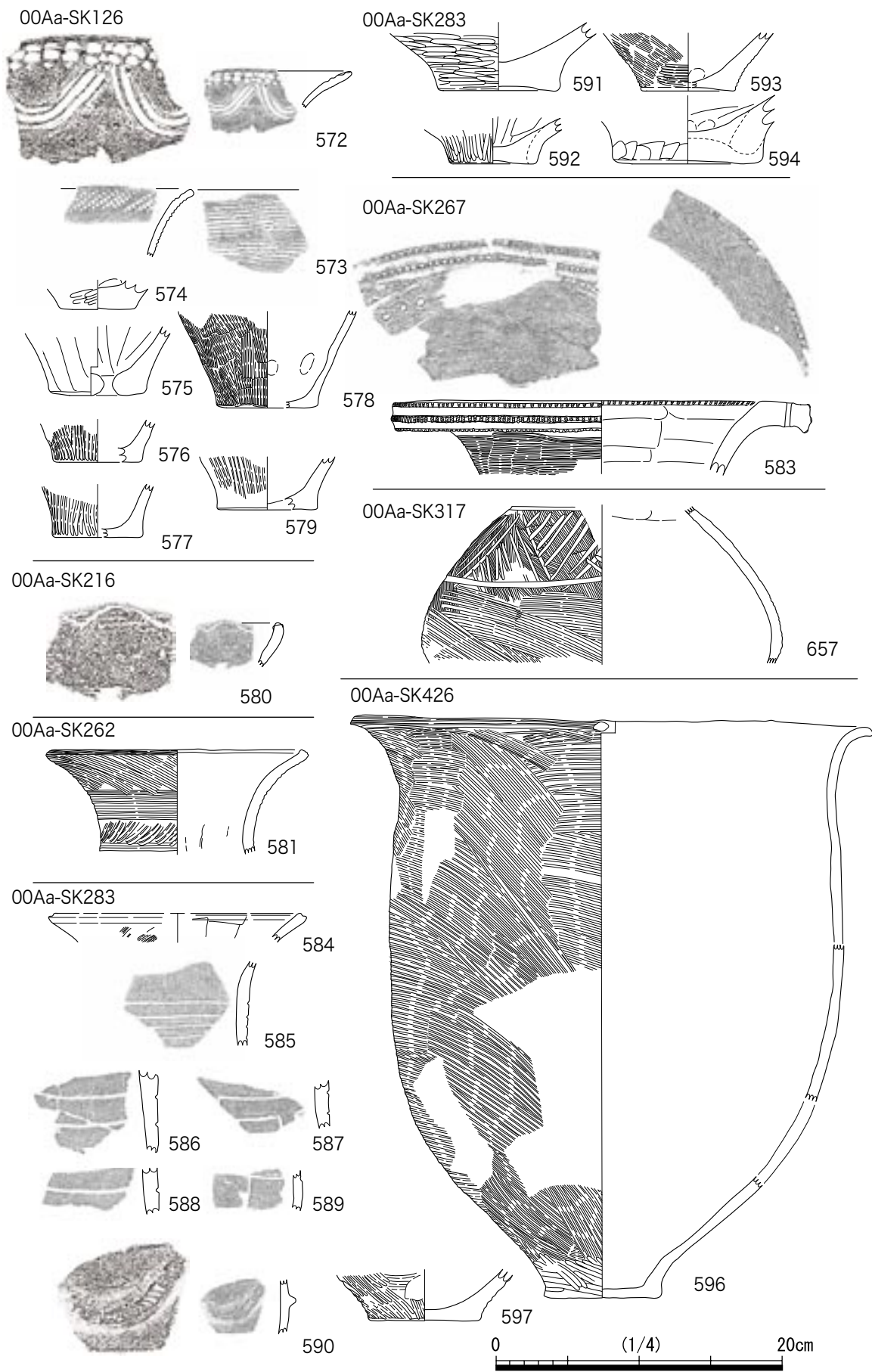

00Aa-SK427

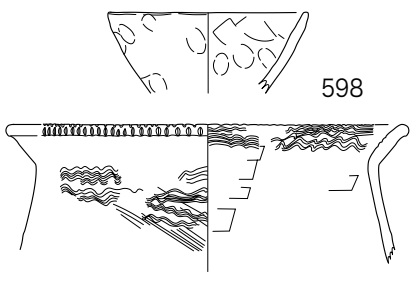

598

00Aa-SK436

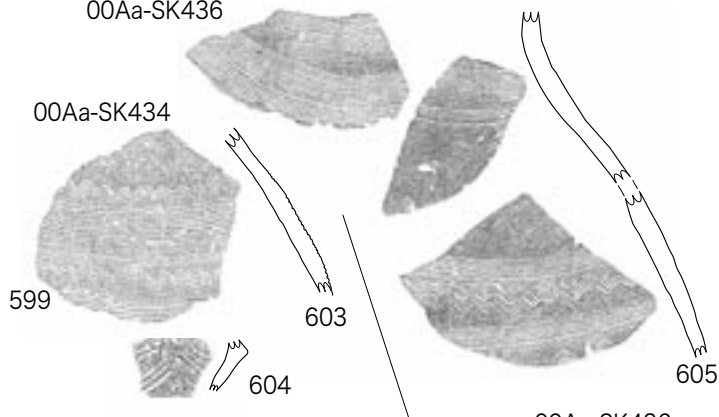

599

603

604

605

00Aa-SK433

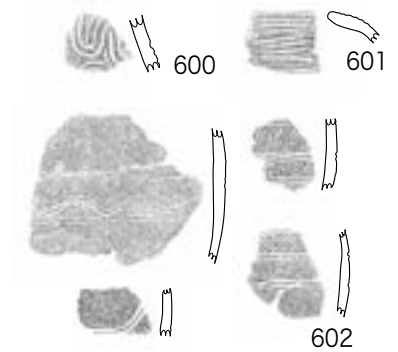

600

601

602

00Aa-SK436

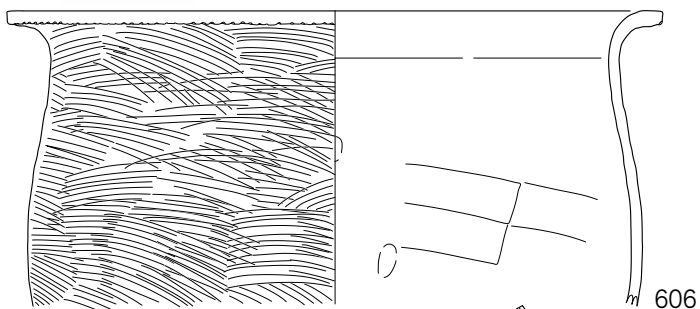

606

00Aa-SK440

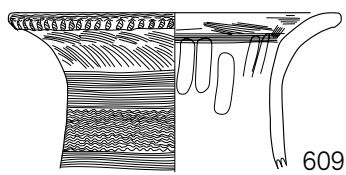

609

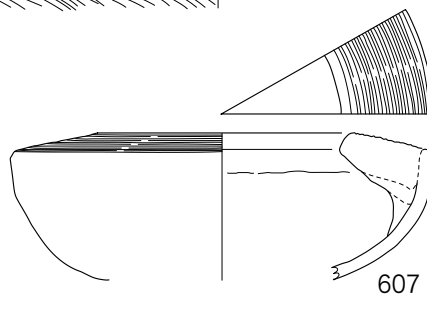

607

00Aa-SK448

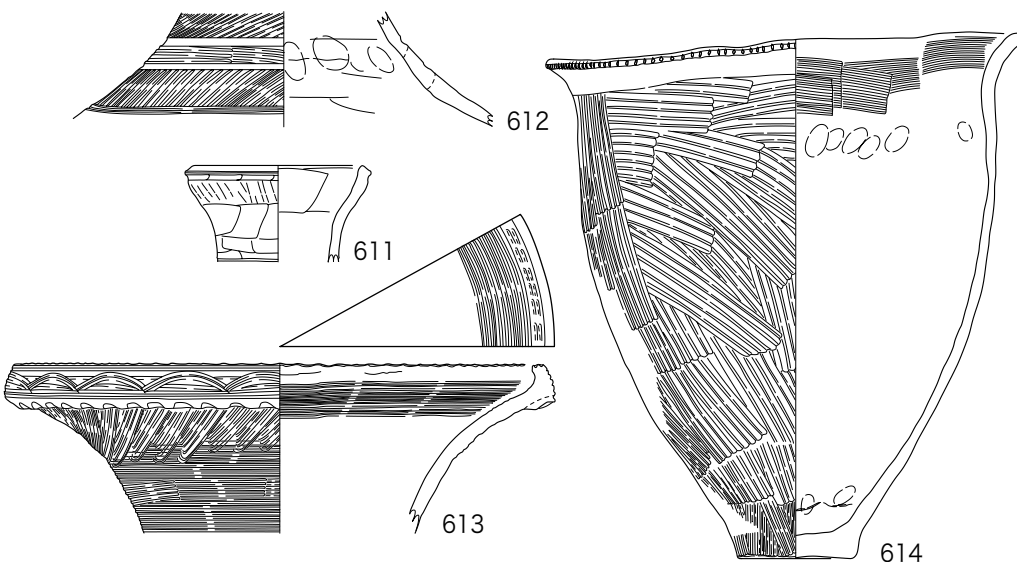

612

611

613

614

00Aa-SK455



615

616

617

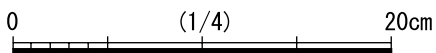

00Aa-SK456

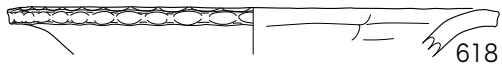

618

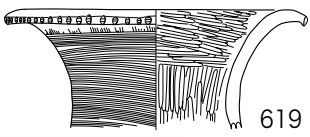

619

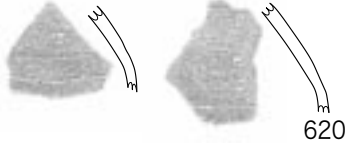

620

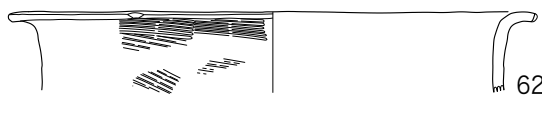

621

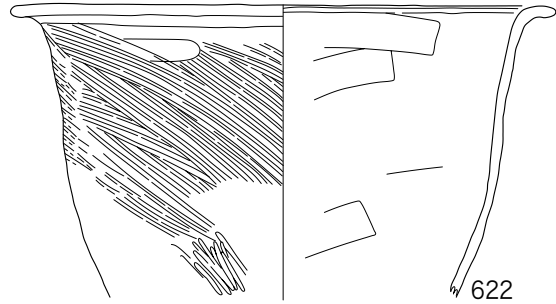

622



623



624

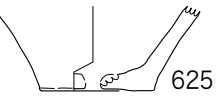

625

00Aa-SK461



626

00Aa-SK465

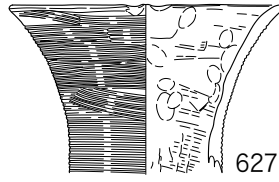

627

00Aa-SK488

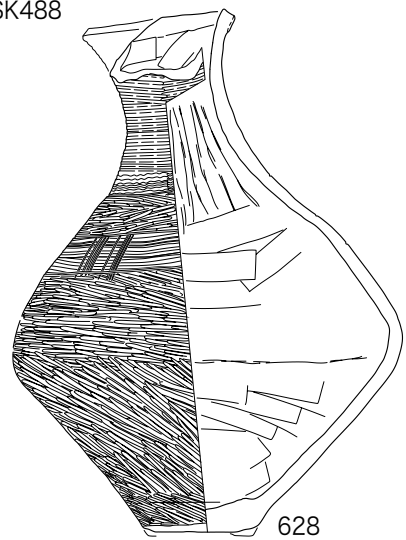

628

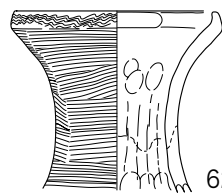

629

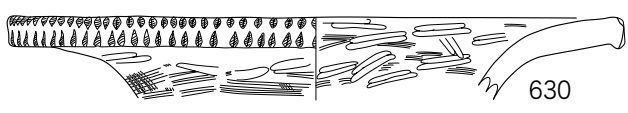

630

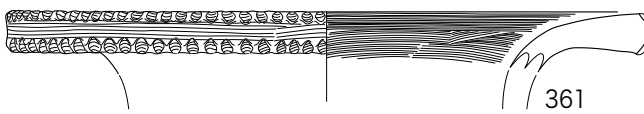

631



632

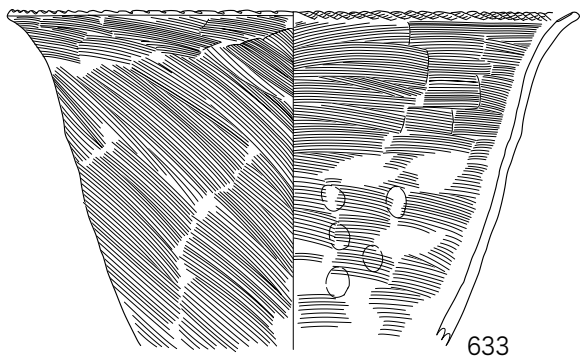

633

00Aa-SK491

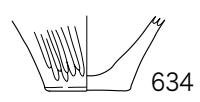

634

00Aa-SK521

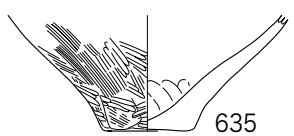

635

00Aa-SK534

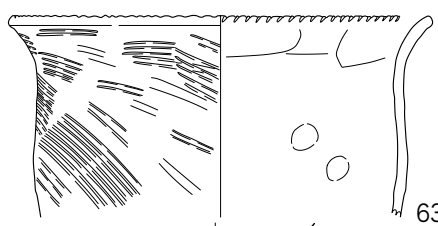

636

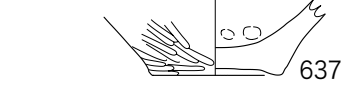

637

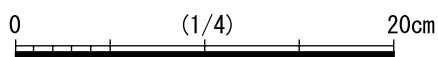

0

(1/4)

20cm

00Aa-SK555

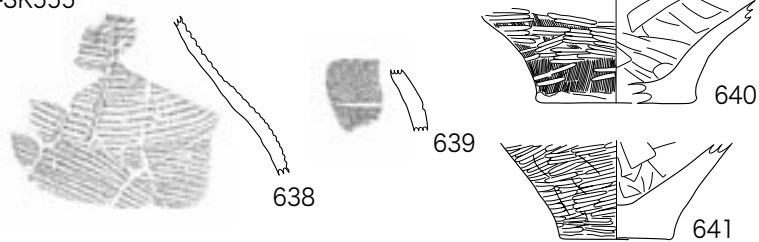

00Aa-SK561

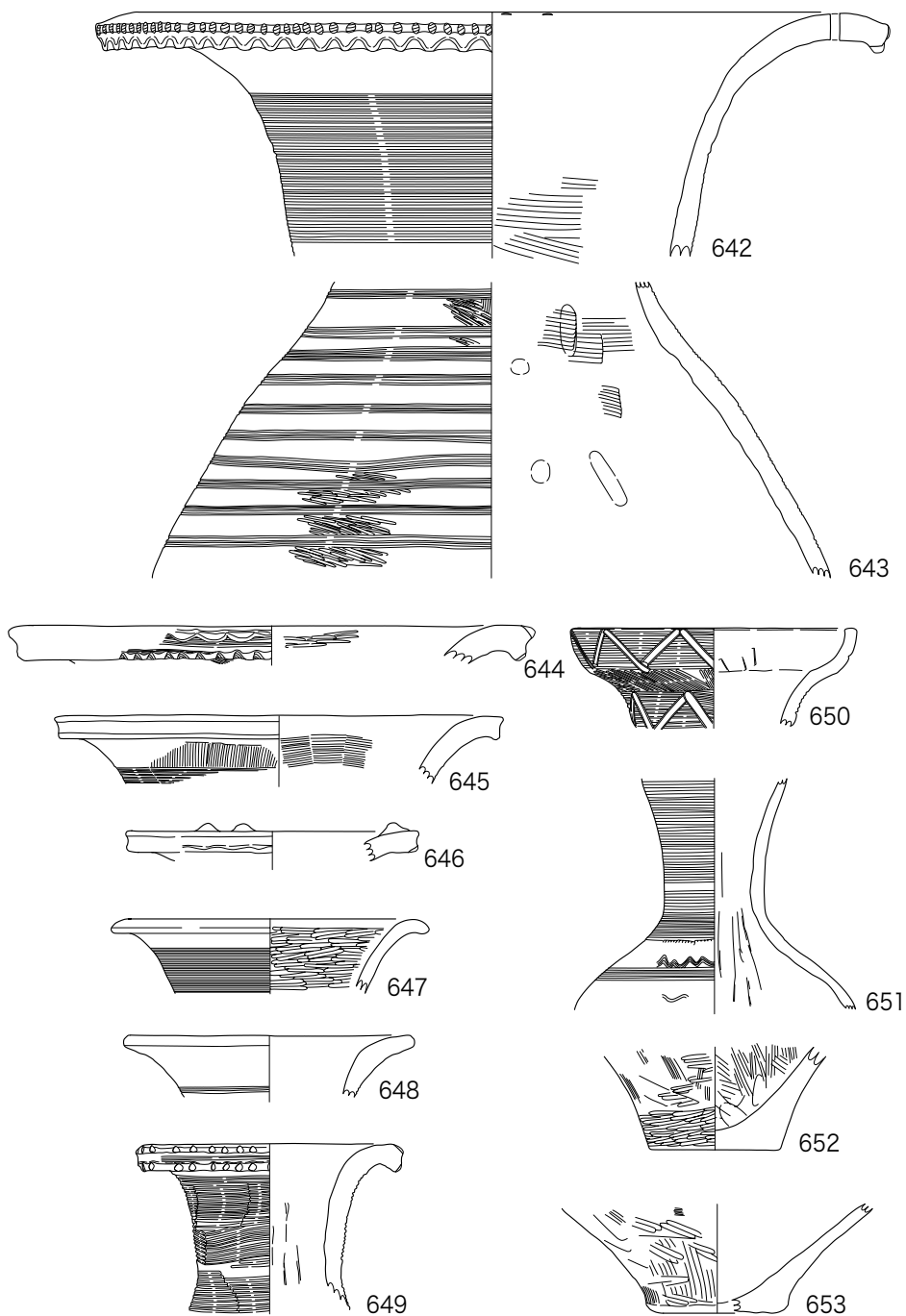

0 (1/4) 20cm

00Aa-SK579

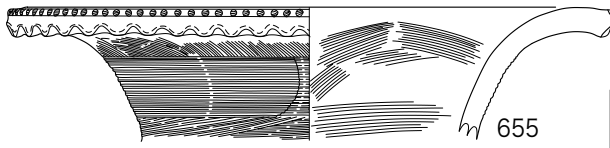

655

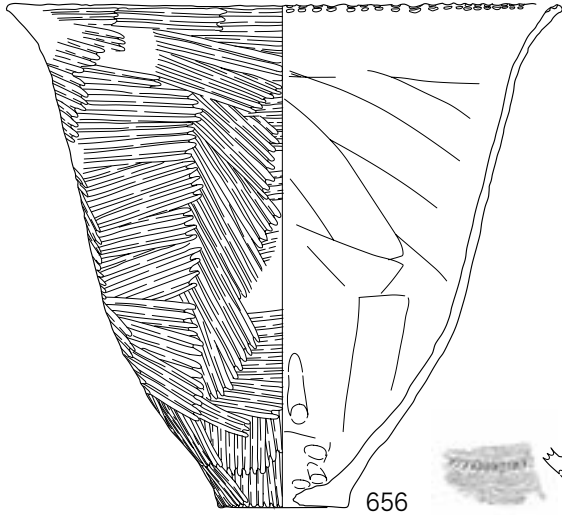

656



657

00Aa-SK622

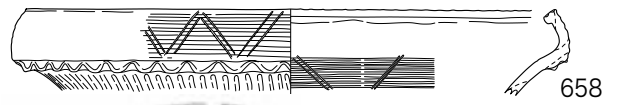

658

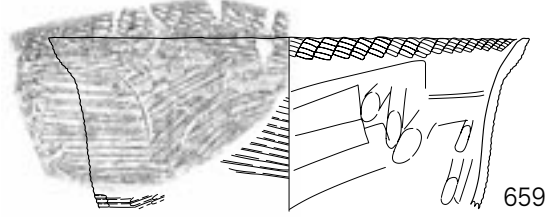

659

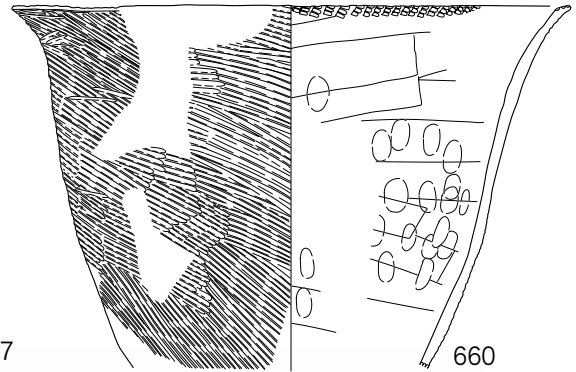

660

00Aa-SK639

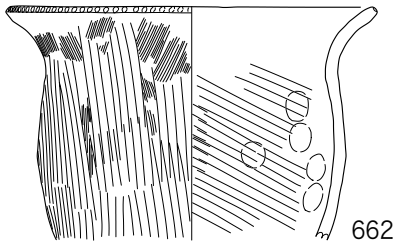

662

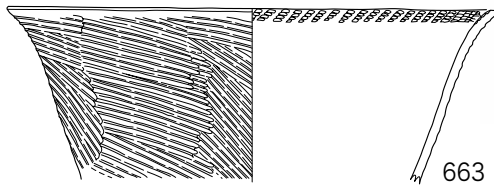

663

00Aa-SK713

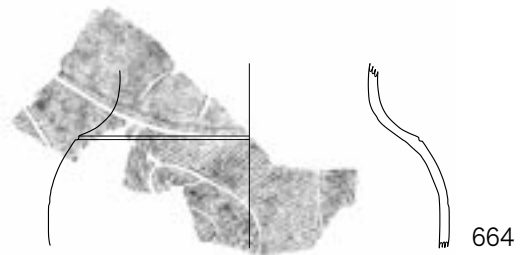

664

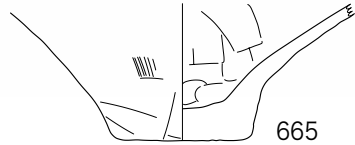

665



666

00Aa-SK715

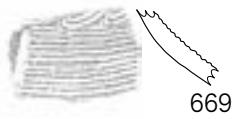

669



667



668

00Aa-SK855

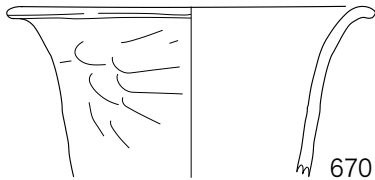

670

00Aa-SK991

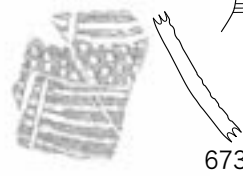

673

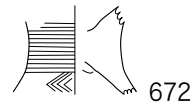

672

00Aa-SK1005

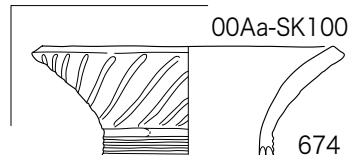

674

00Aa-SK937

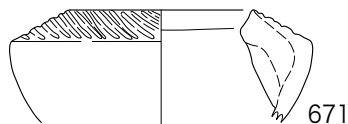

671

00Aa-SK1026

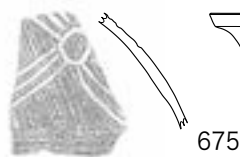

675

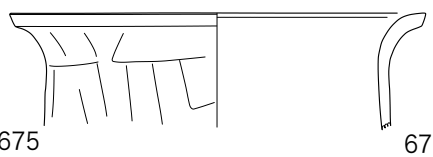

676

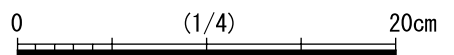

00Aa-SK716

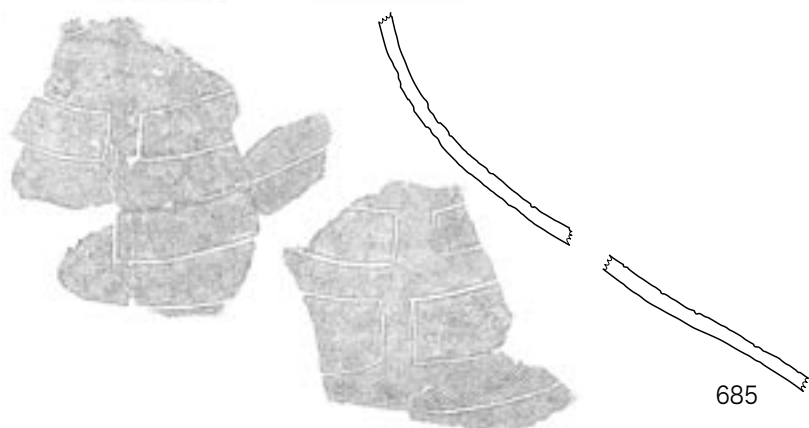
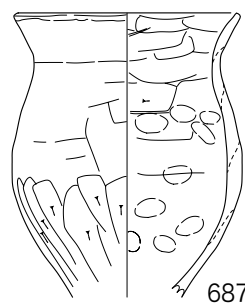
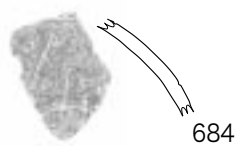
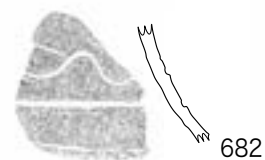
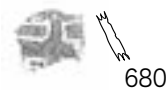
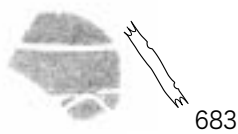
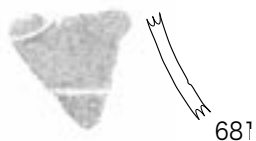
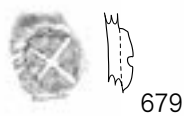
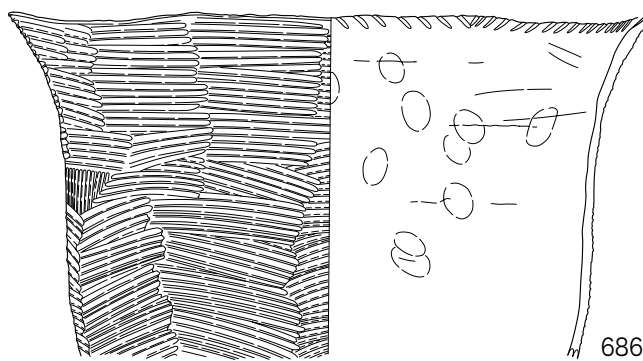
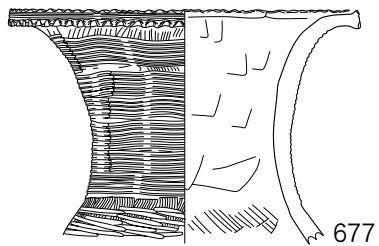

00Aa-SK911

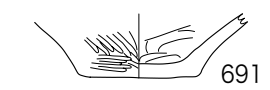
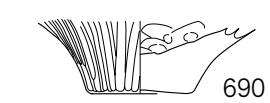
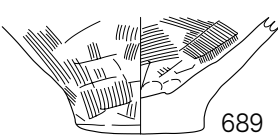
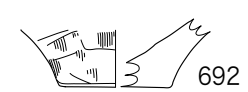
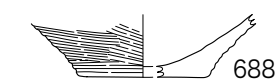

00Aa-SK976

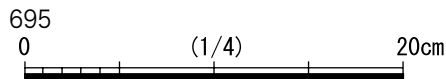
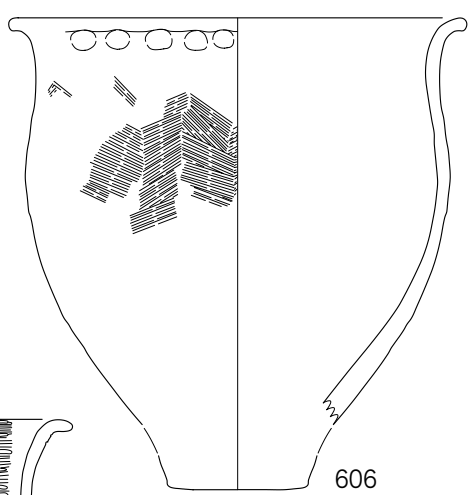
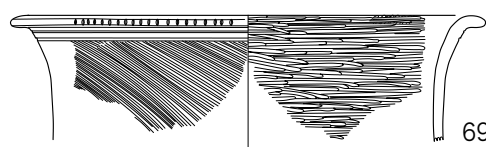
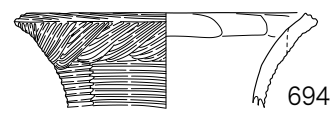

00Aa-SK1038

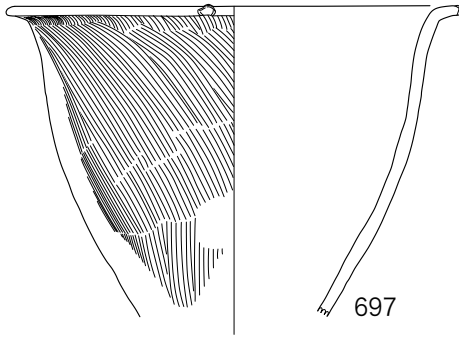

00Aa-SK1052

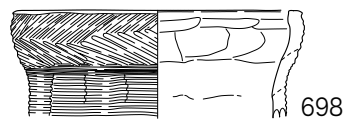

00Aa-SK1057

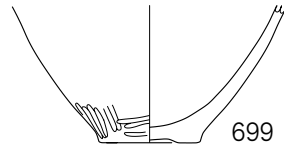

00Aa-SK1043

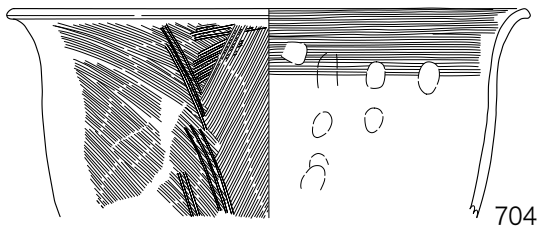
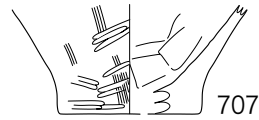
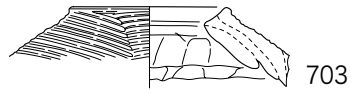
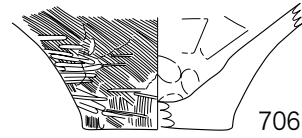
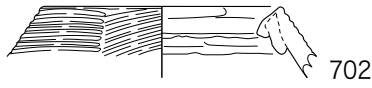
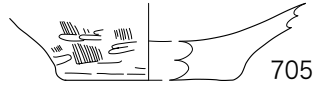

00Aa-SK1063

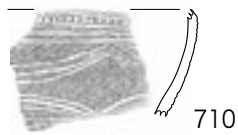

00Aa-SK1064

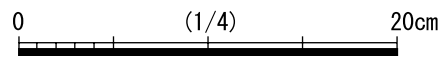
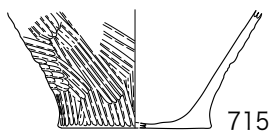
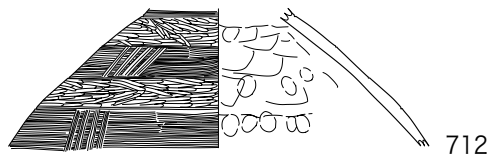
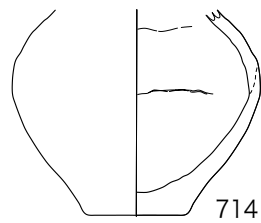
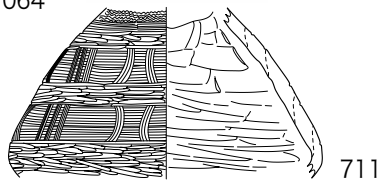

00Aa-SK1072

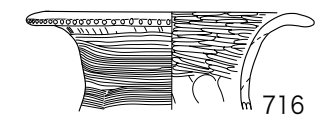

716

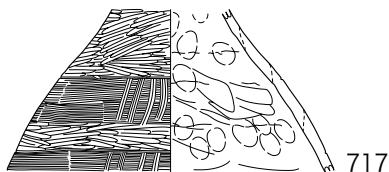

717



718

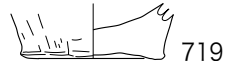

719

00Aa-SK1098



720

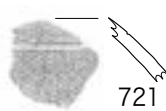

721

00Aa-SK1102

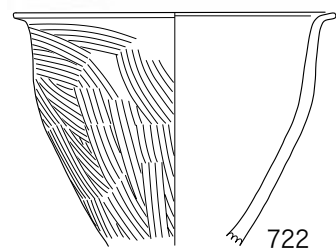

722



723



724

00Aa-SK1149

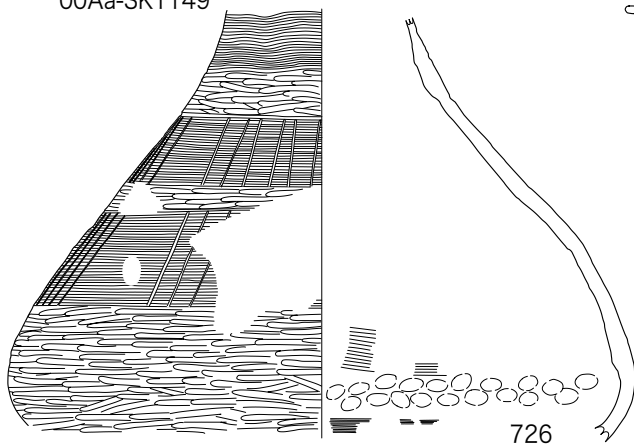

726

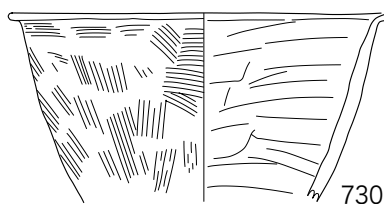

730

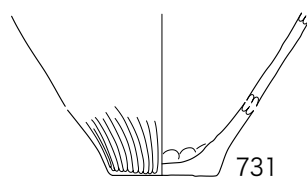

731

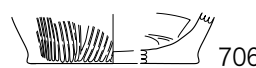

706

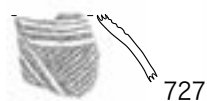

727

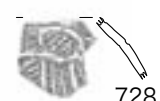

728

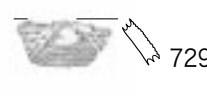

729

00Aa-SK1238

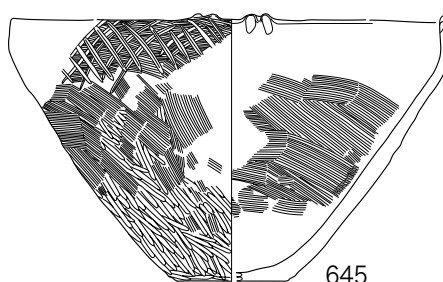

645

00Aa-SK1197



733

00Aa-SK1204



734

00Aa-SK1225

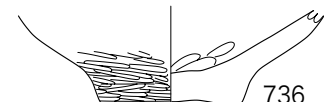

736

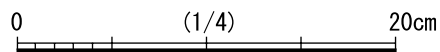

00Ab-SK04

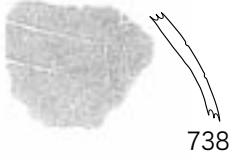

00Ab-SK21



00Ab-SK72



00Ab-SK101

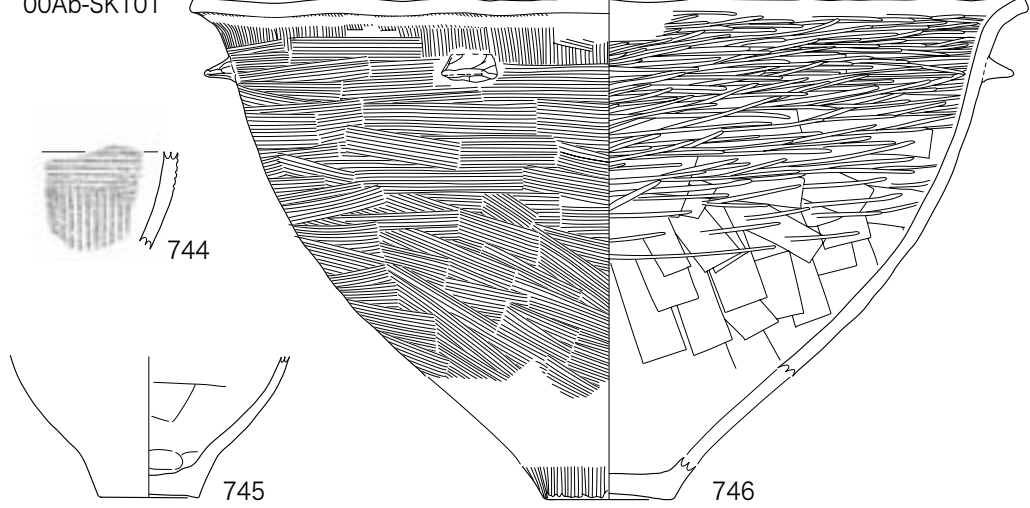

00Ab-SK129

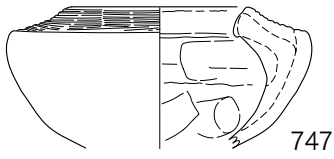

00Ab-SK173

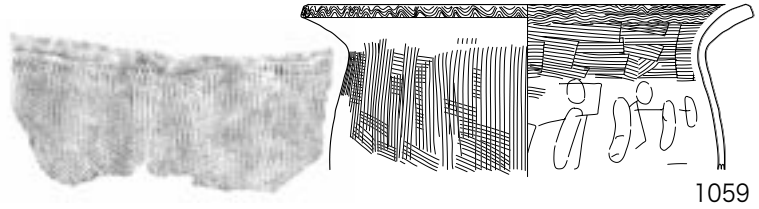

00Ab-SK164

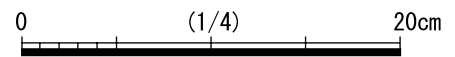
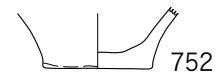
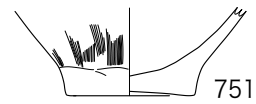
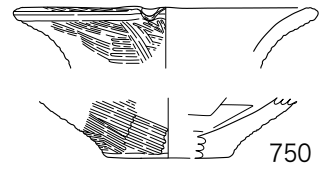
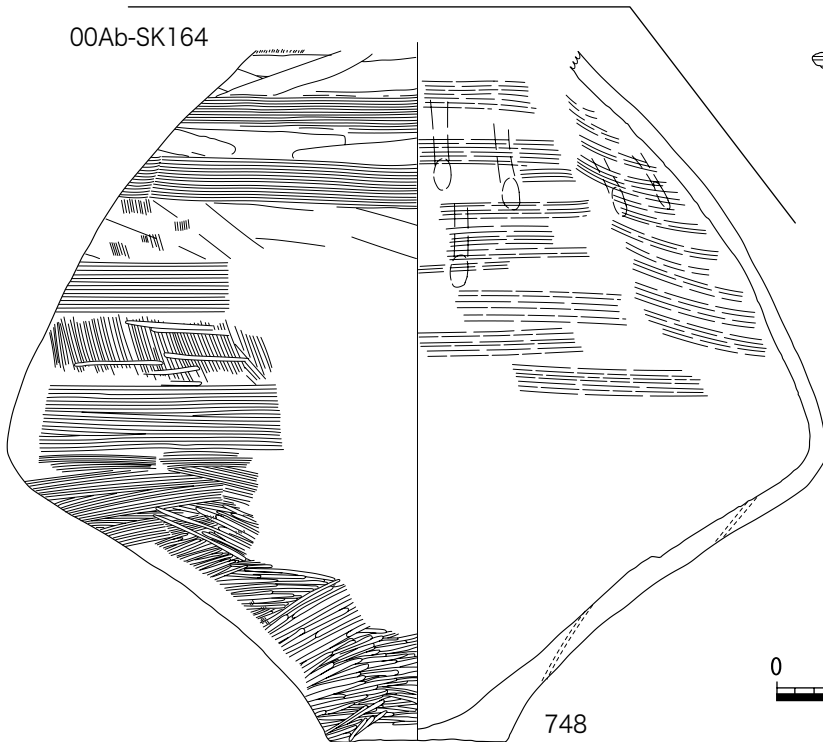

00Ab-SK191



00Ab-SK199



00Ab-SK213

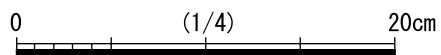
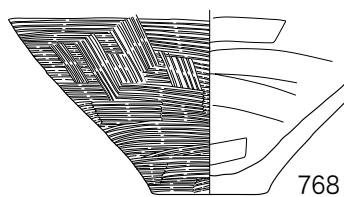
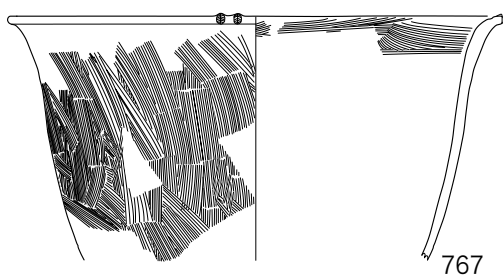
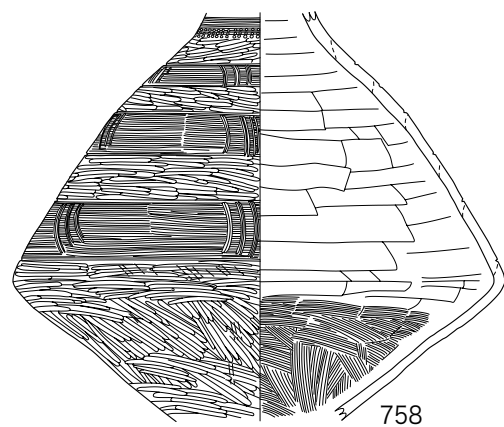
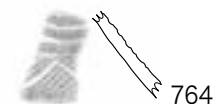
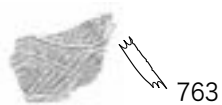
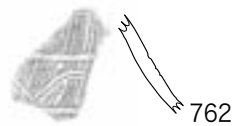
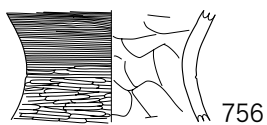
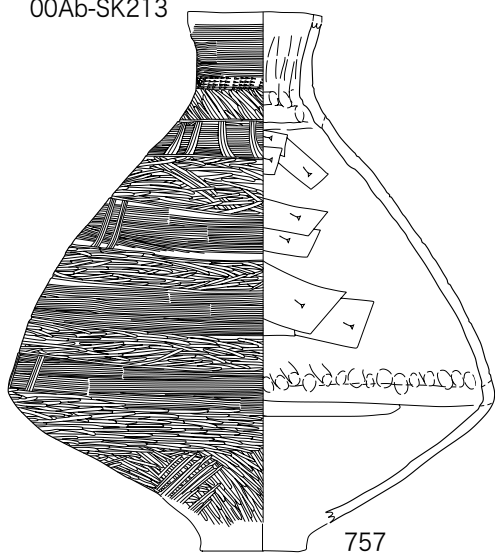

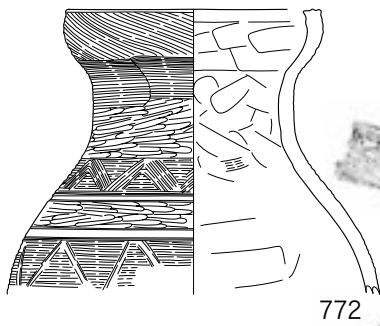

00Ab-SK230



00Ab-SK237

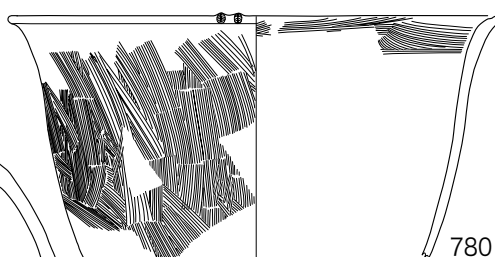
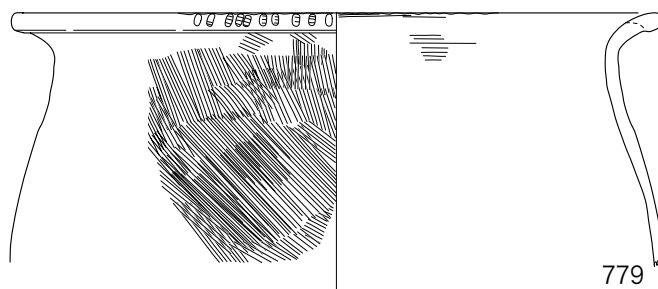
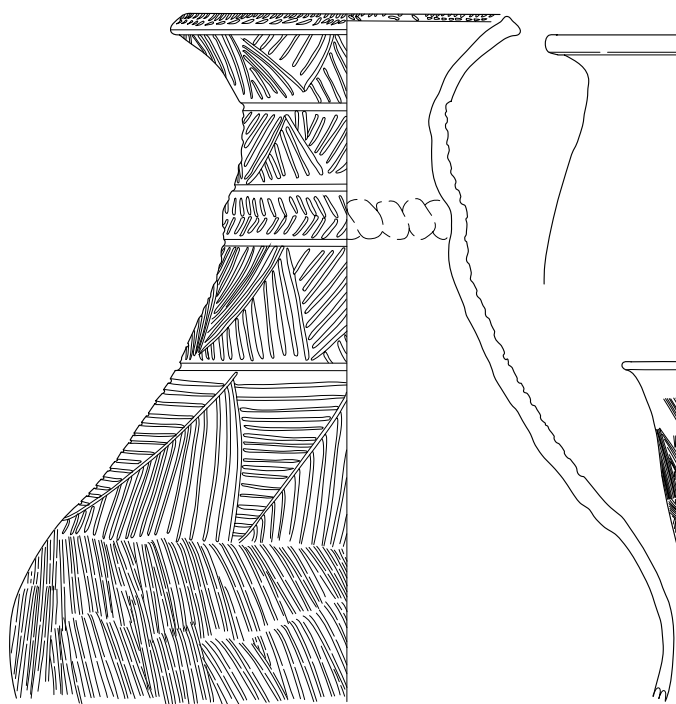
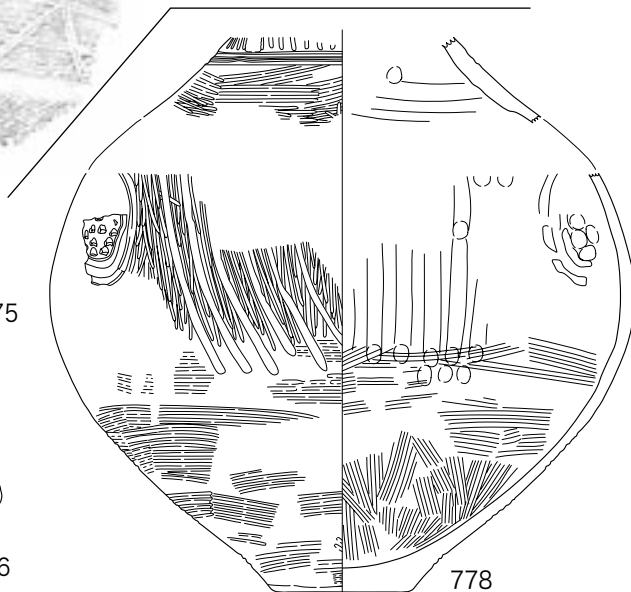
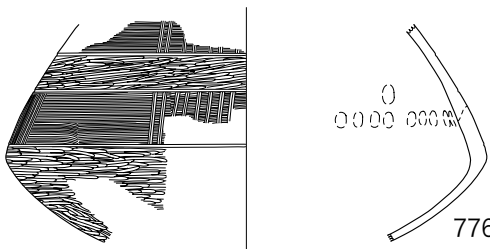
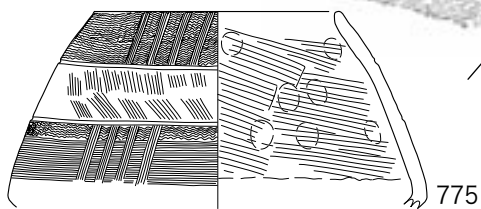
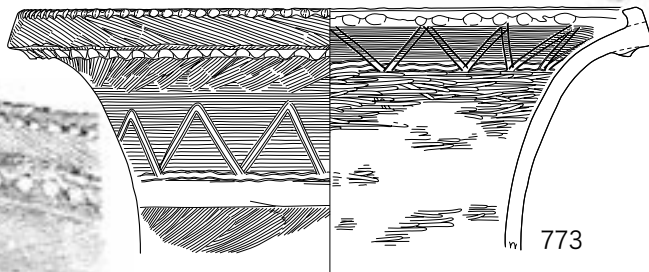
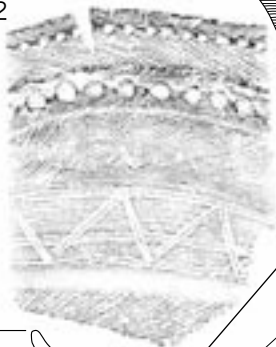
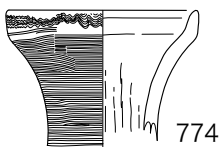

0 (1/4) 20cm

00Ab-SK188

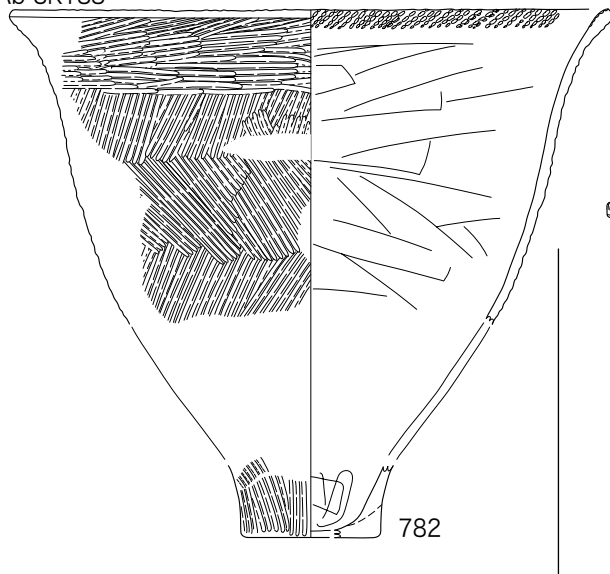

00Ab-SK242

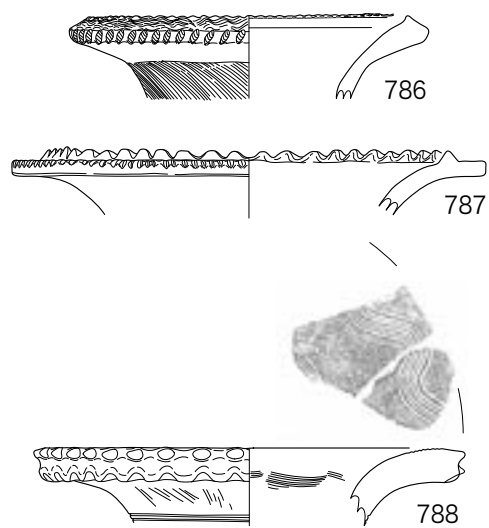

00Ab-SK228

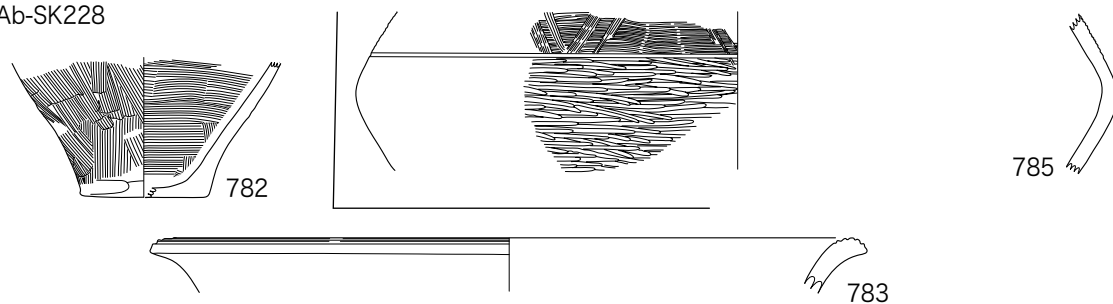

00Ab-SK264

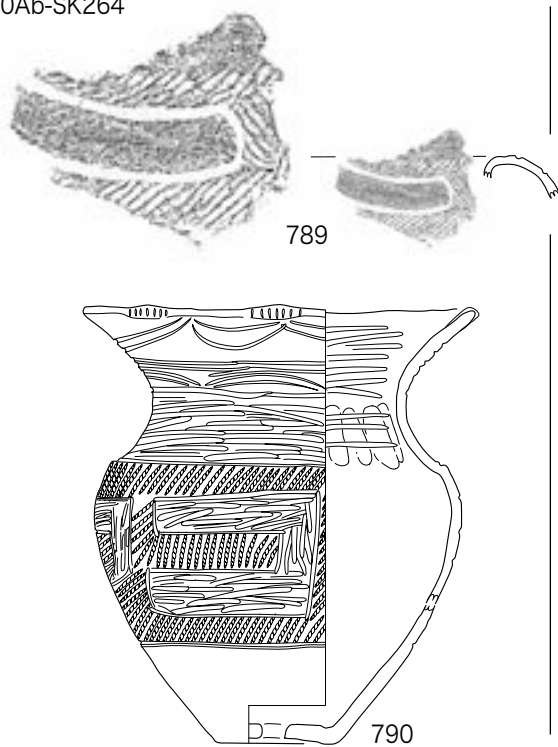

00Ab-SK266

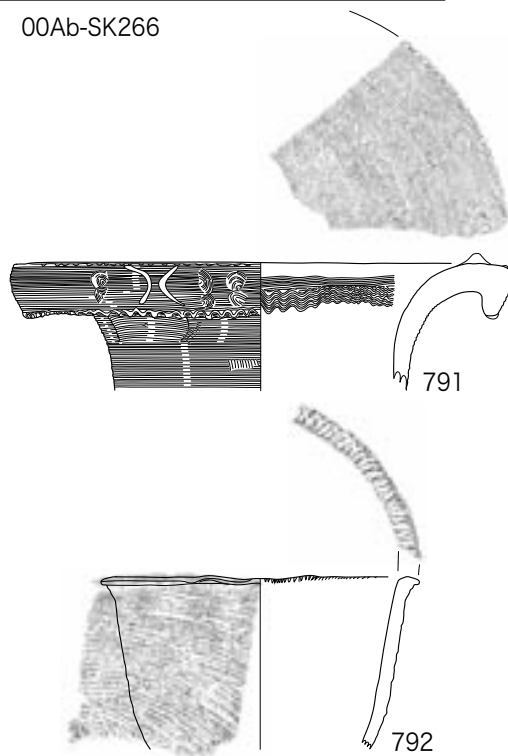

0 (1/4) 20cm

00Ac-SK219

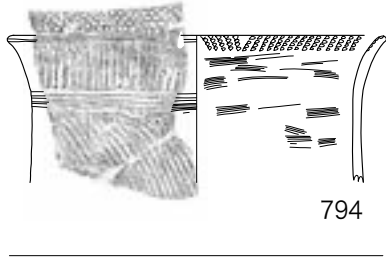

00Ac-SK254

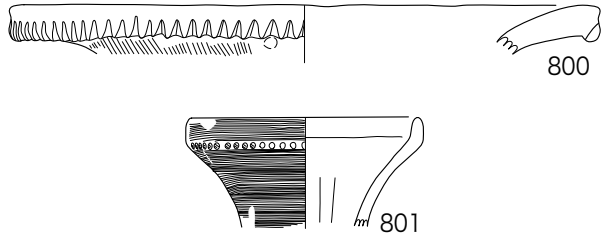

00Ac-SK250

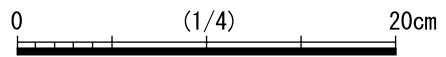
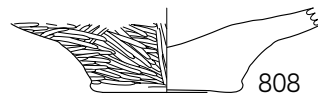
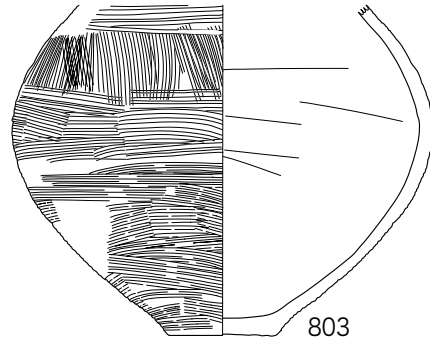
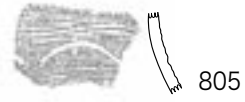
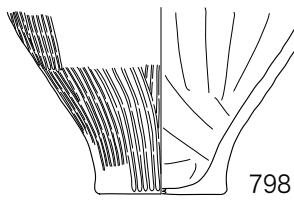
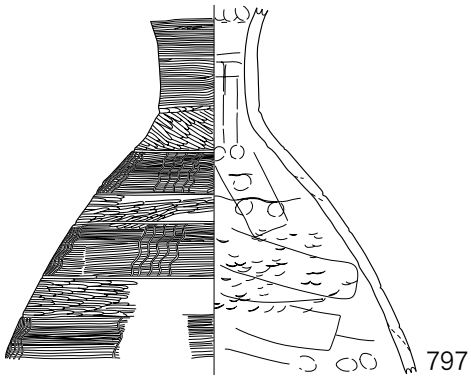
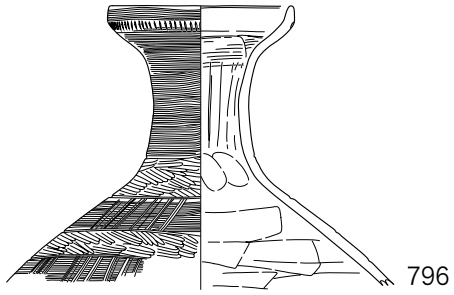

00Ac-SK260

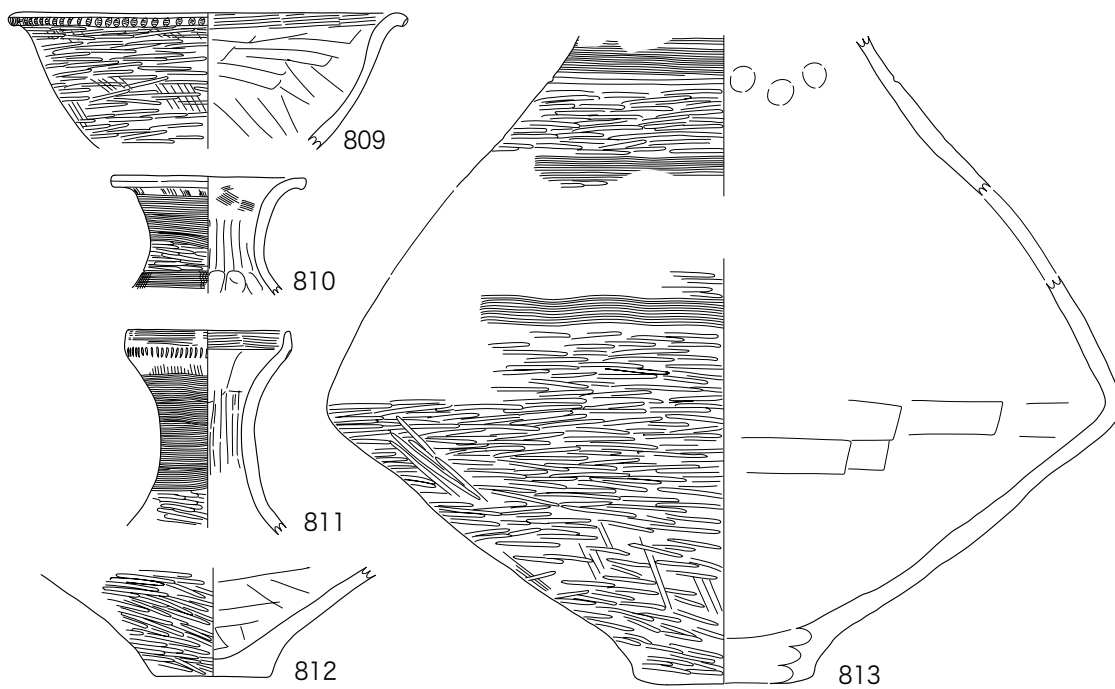

00Ac-SK267

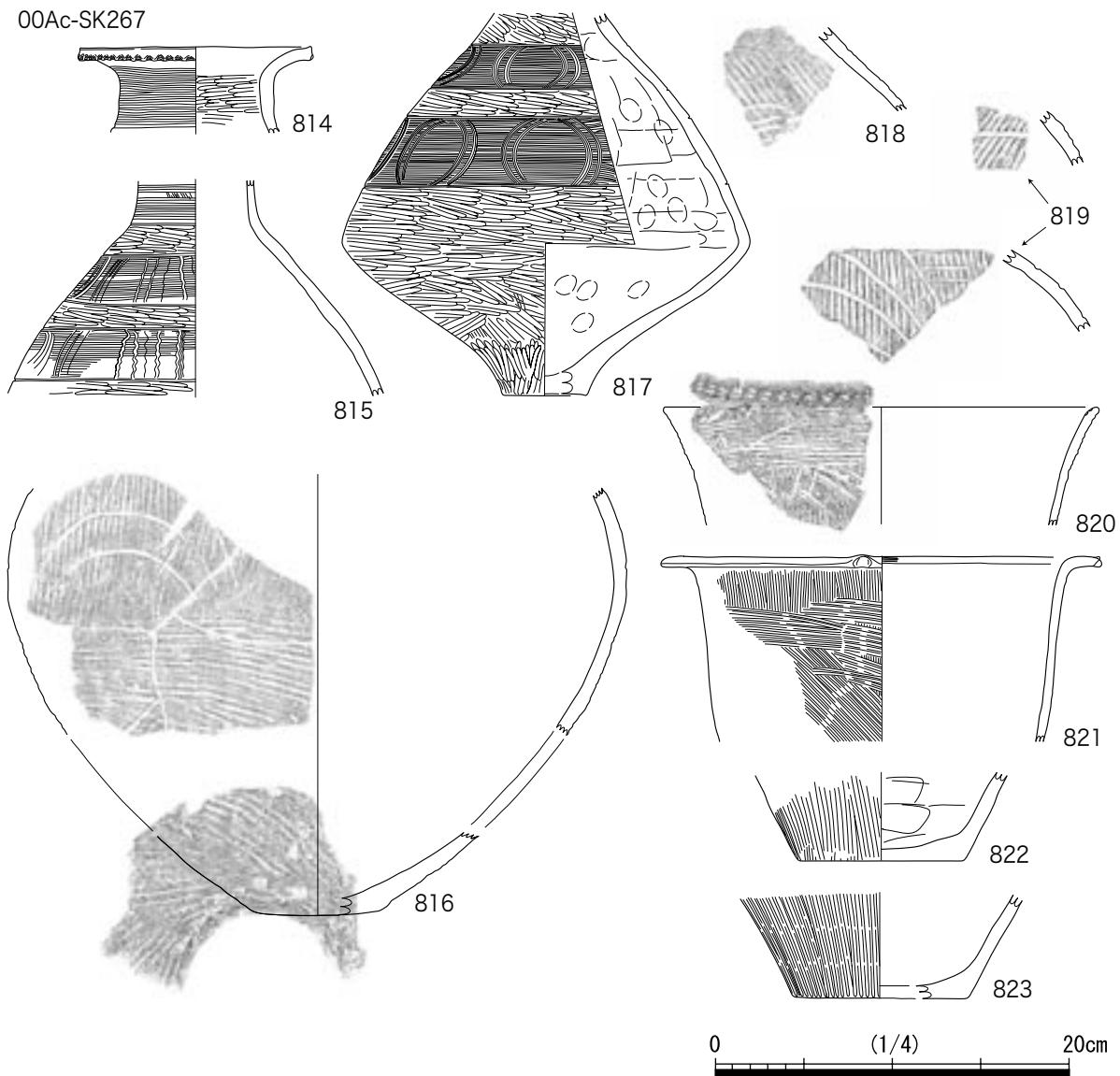

00Aa-SD03

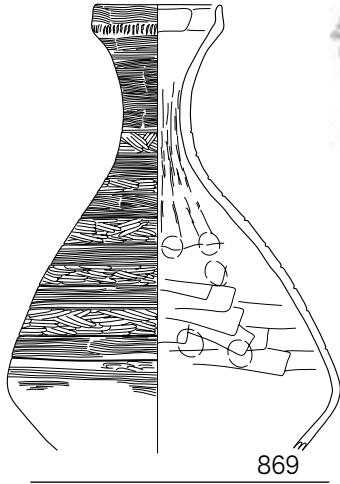

869

00Aa-SD08



870

00Aa-SD19



871

00Aa-SD36



872

00Aa-SD47

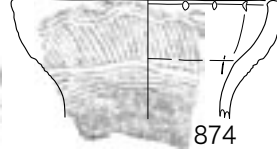

874

00Aa-SD44

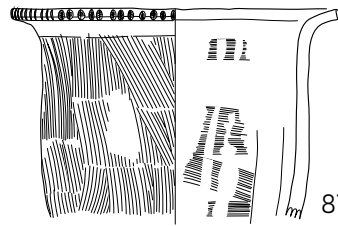

873

00Aa-SD77

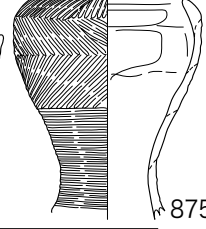

875

00Ab-SD01



876

00Ab-SD10

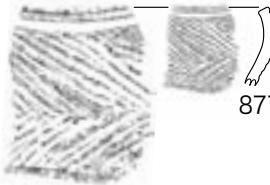

877

00Ab-SD42

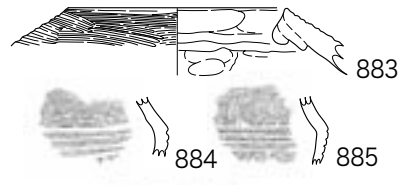

883

884

885

886

00Ab-SD03

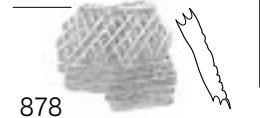

878

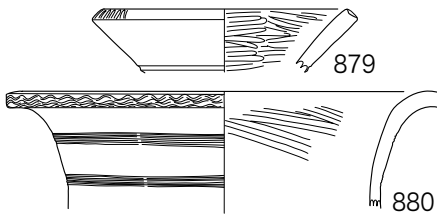

879

880

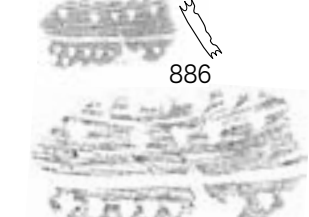

887



00Ab-SD38

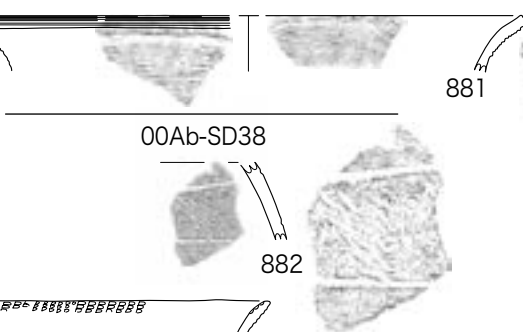

882

00Ab-SD46



888

00Ac-SD44

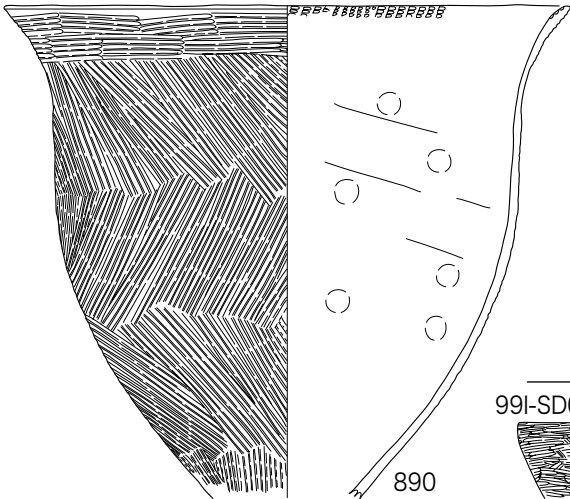

890

99A-SD08

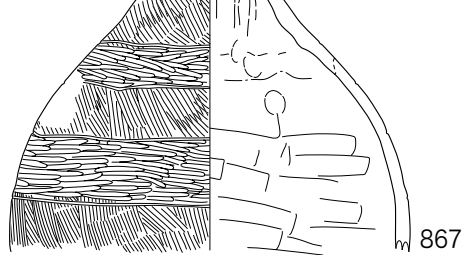

867

99I-SD01

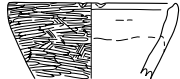

868

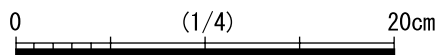

00Aa-SD01

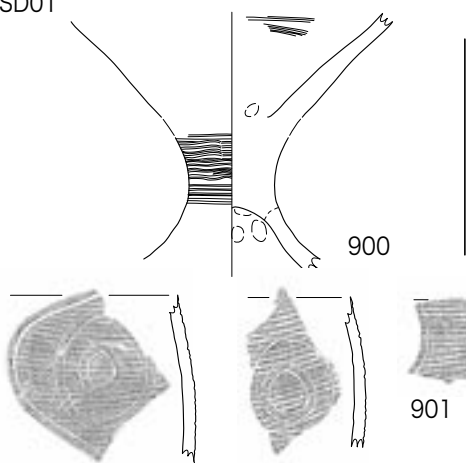

99Ca-SD16

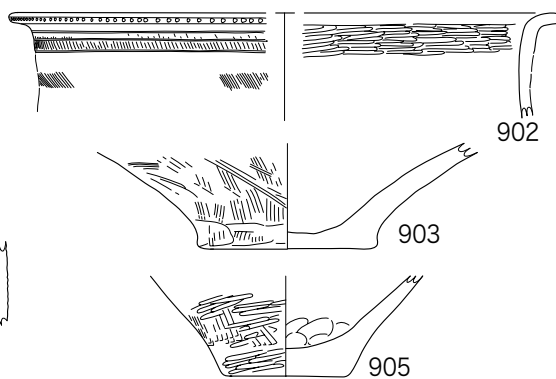

99Cb-SD16下層

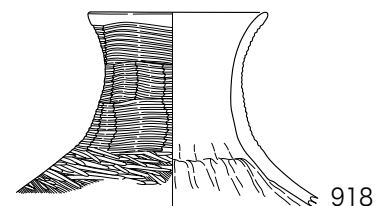
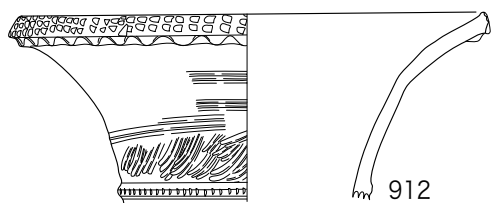
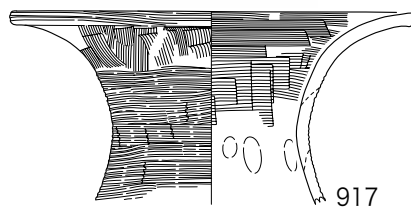
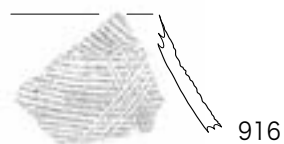
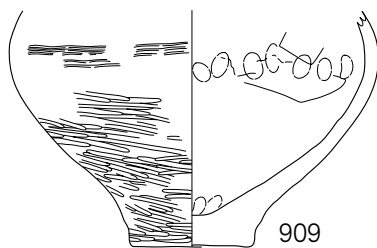
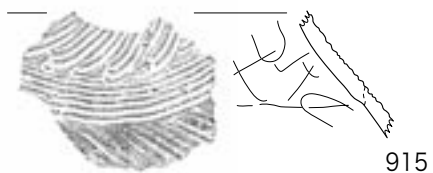
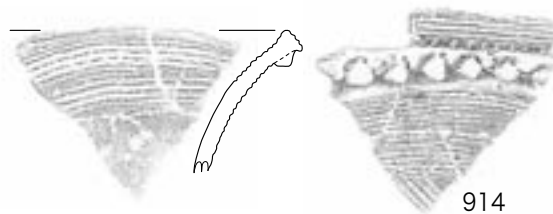
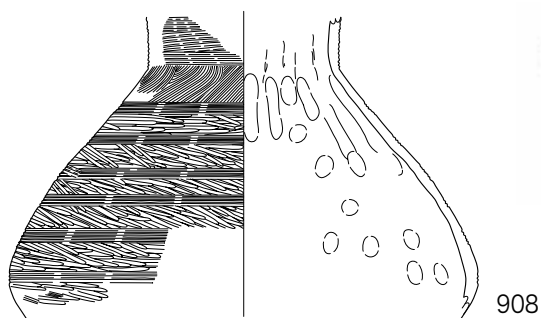
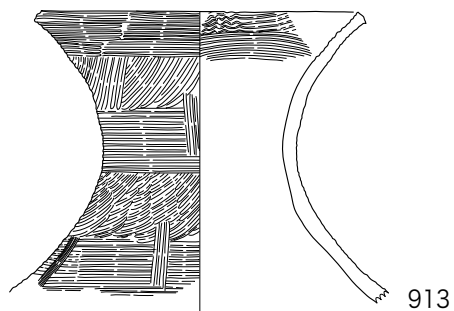
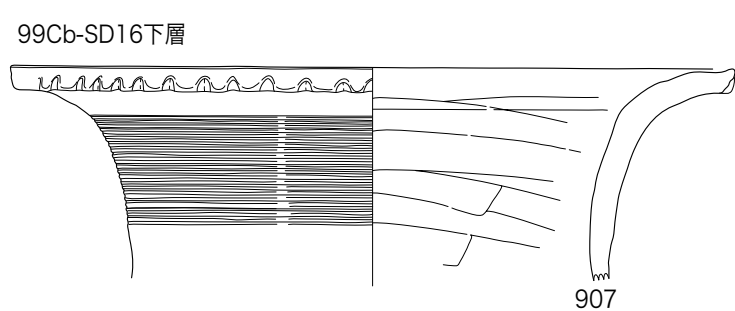

0 (1/4) 20cm

99Cb-SD16下層

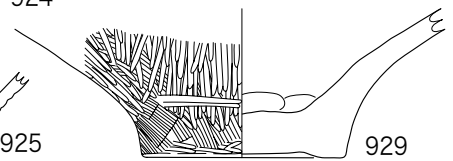
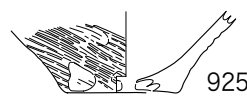
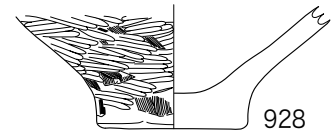
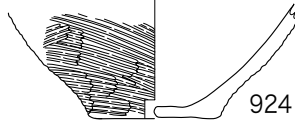
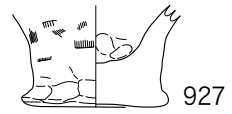
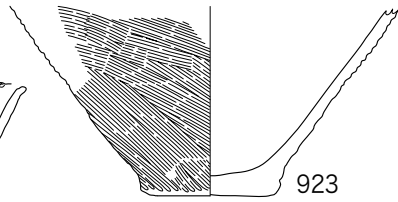
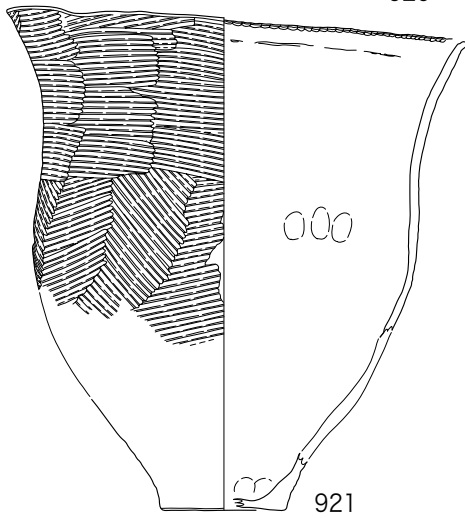
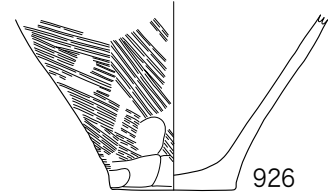
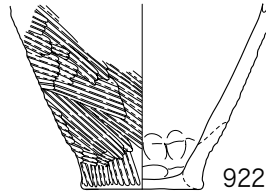
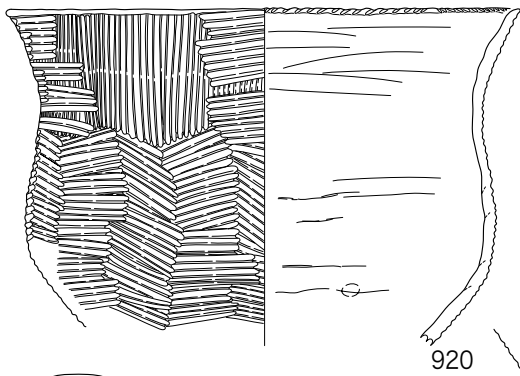
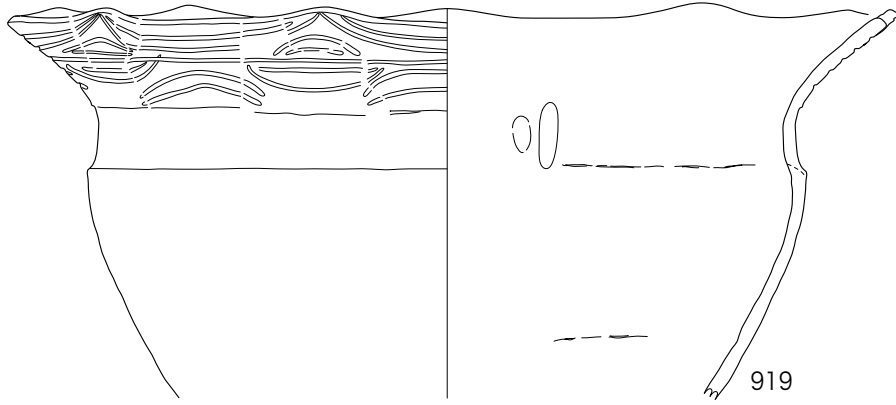

99H-SD01下層

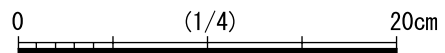
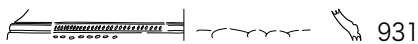
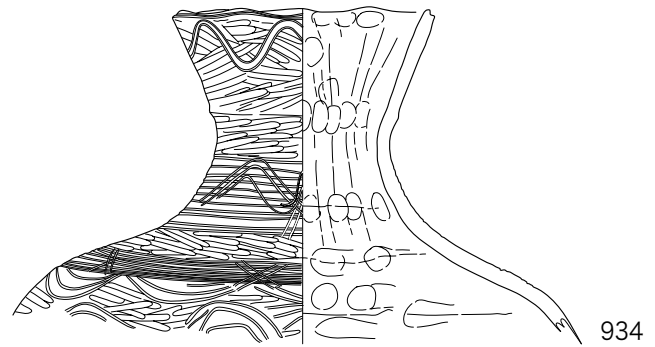
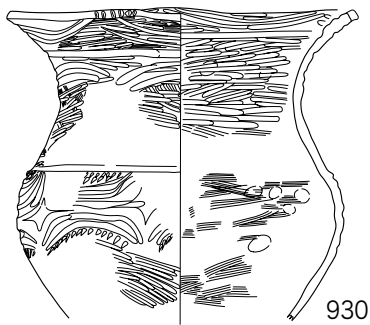

99H-SD01下層

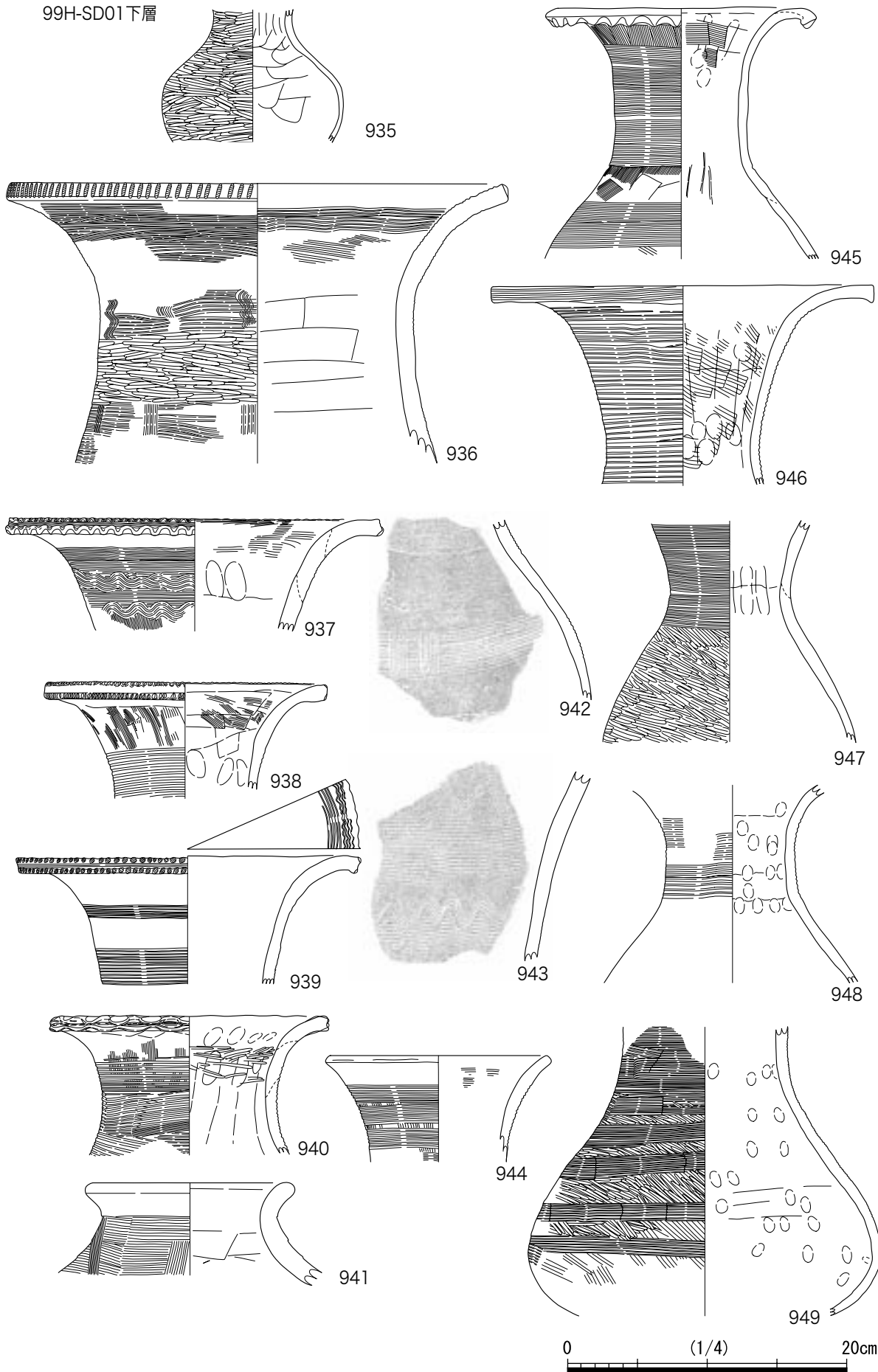

99H-SD01下層

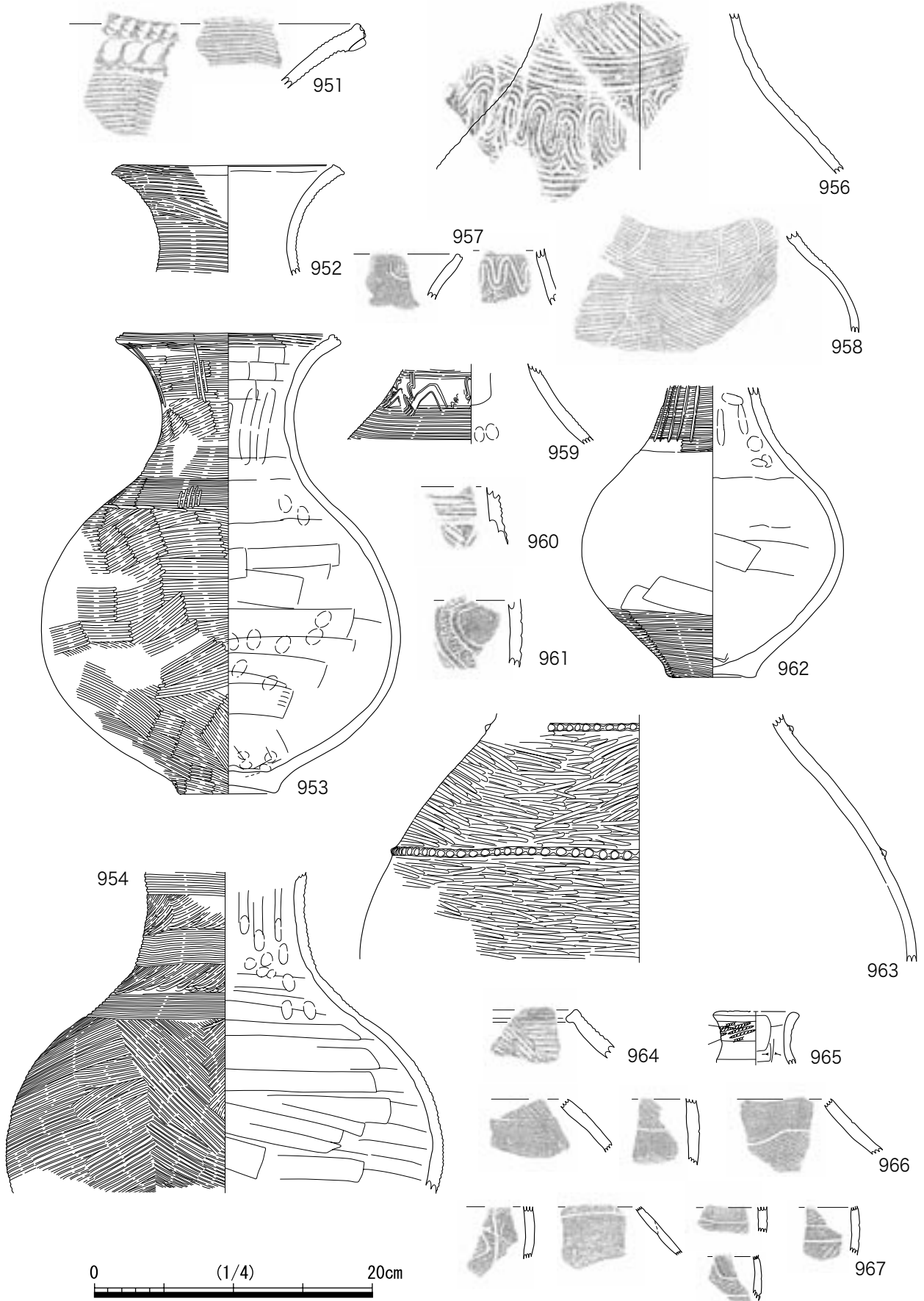

99H-SD01下層

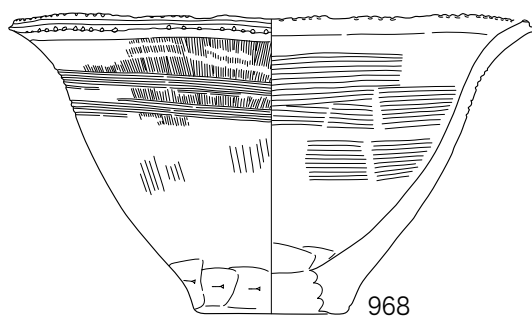

968

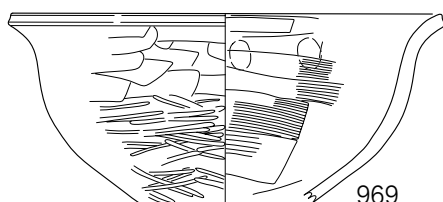

969

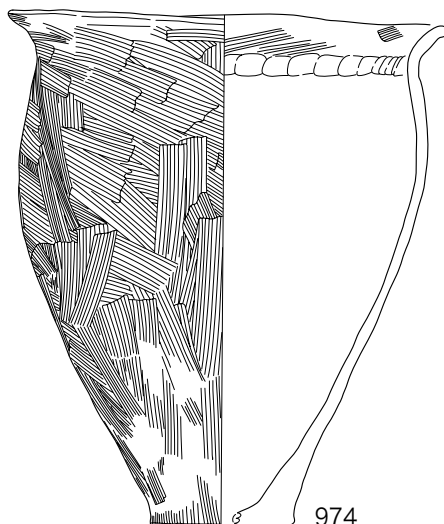

974

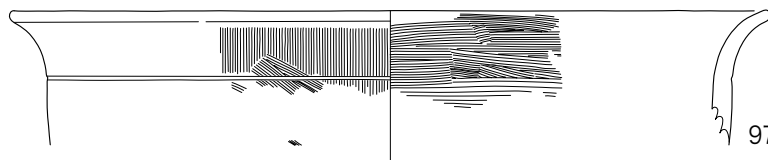

970

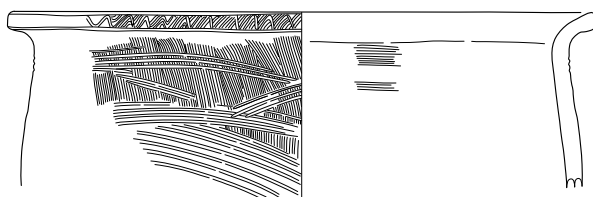

971

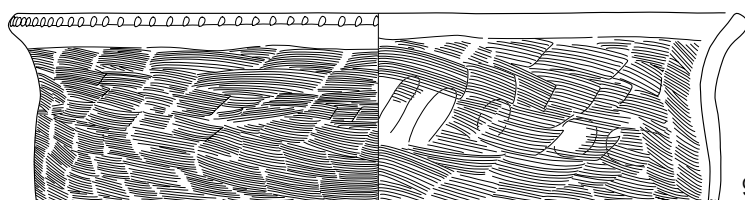

972

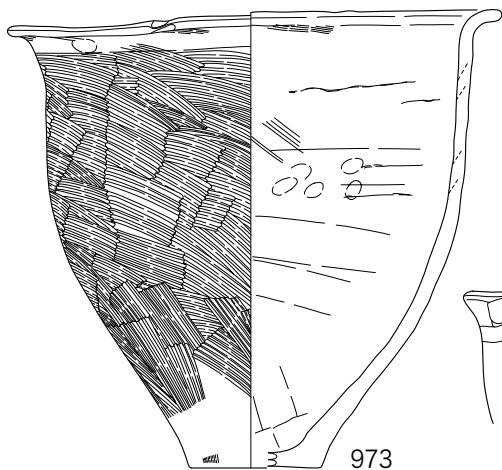

973

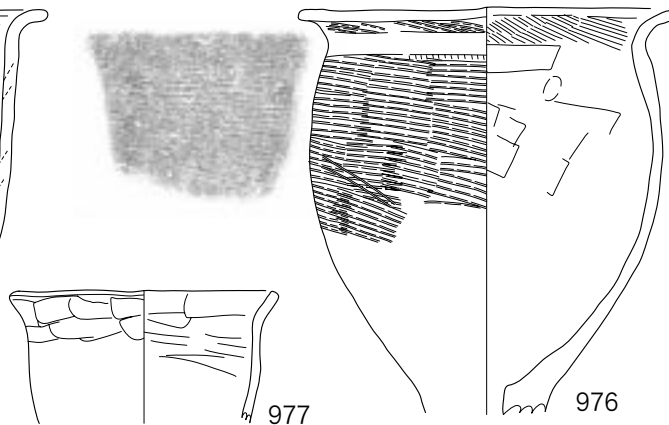

977

976

0 (1/4) 20cm

99H-SD01下層

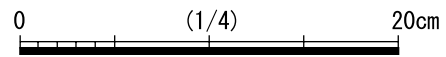
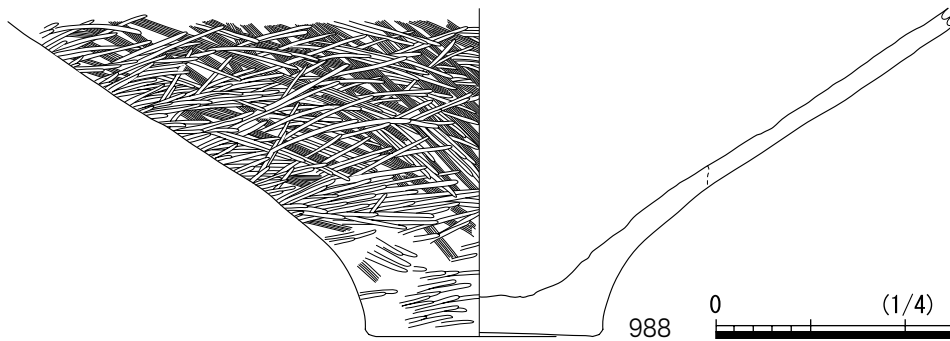
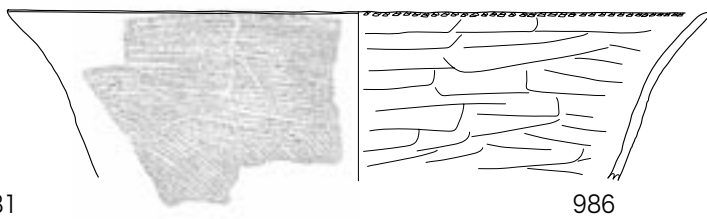
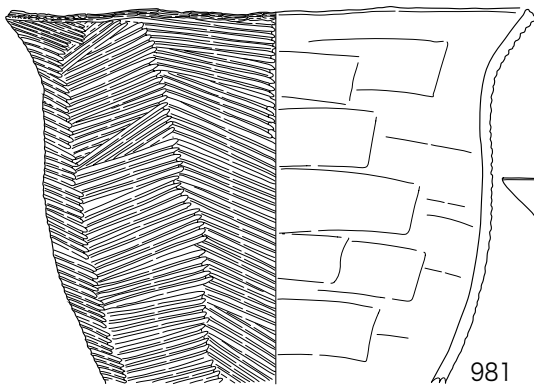
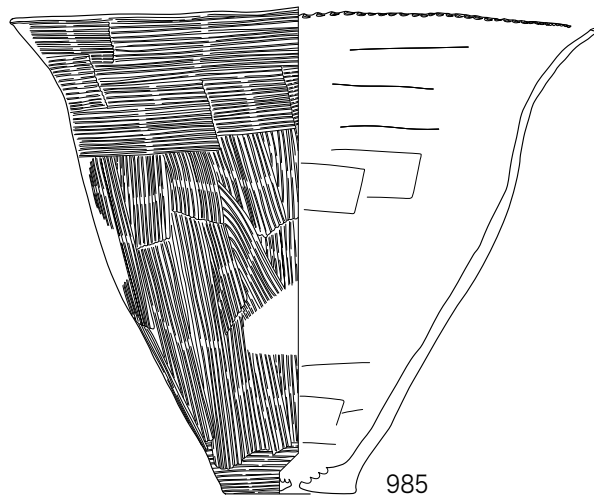
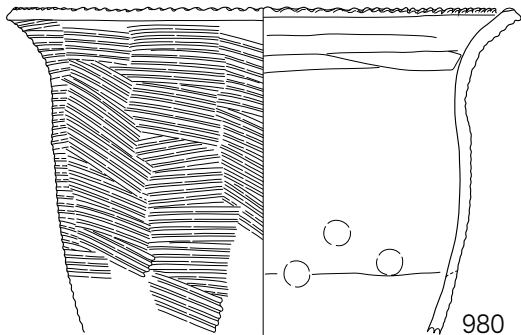
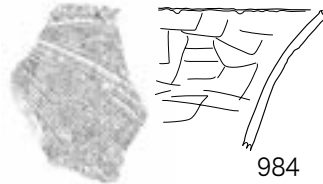
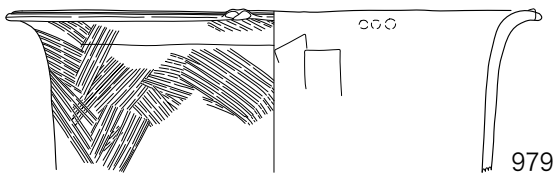
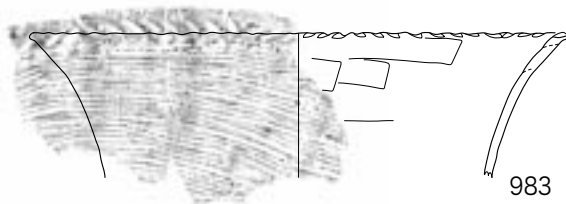
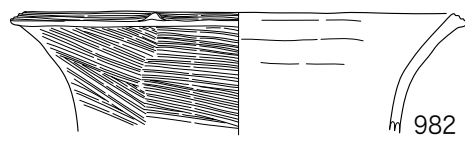
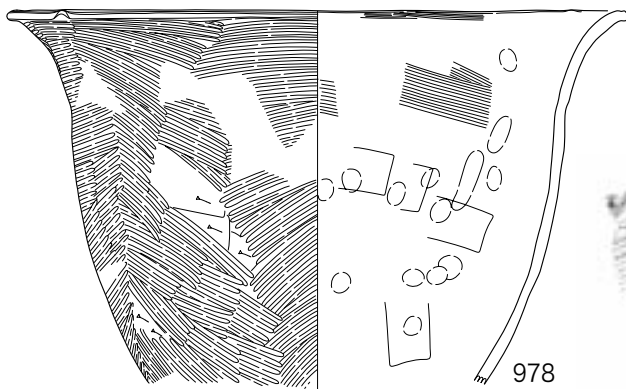

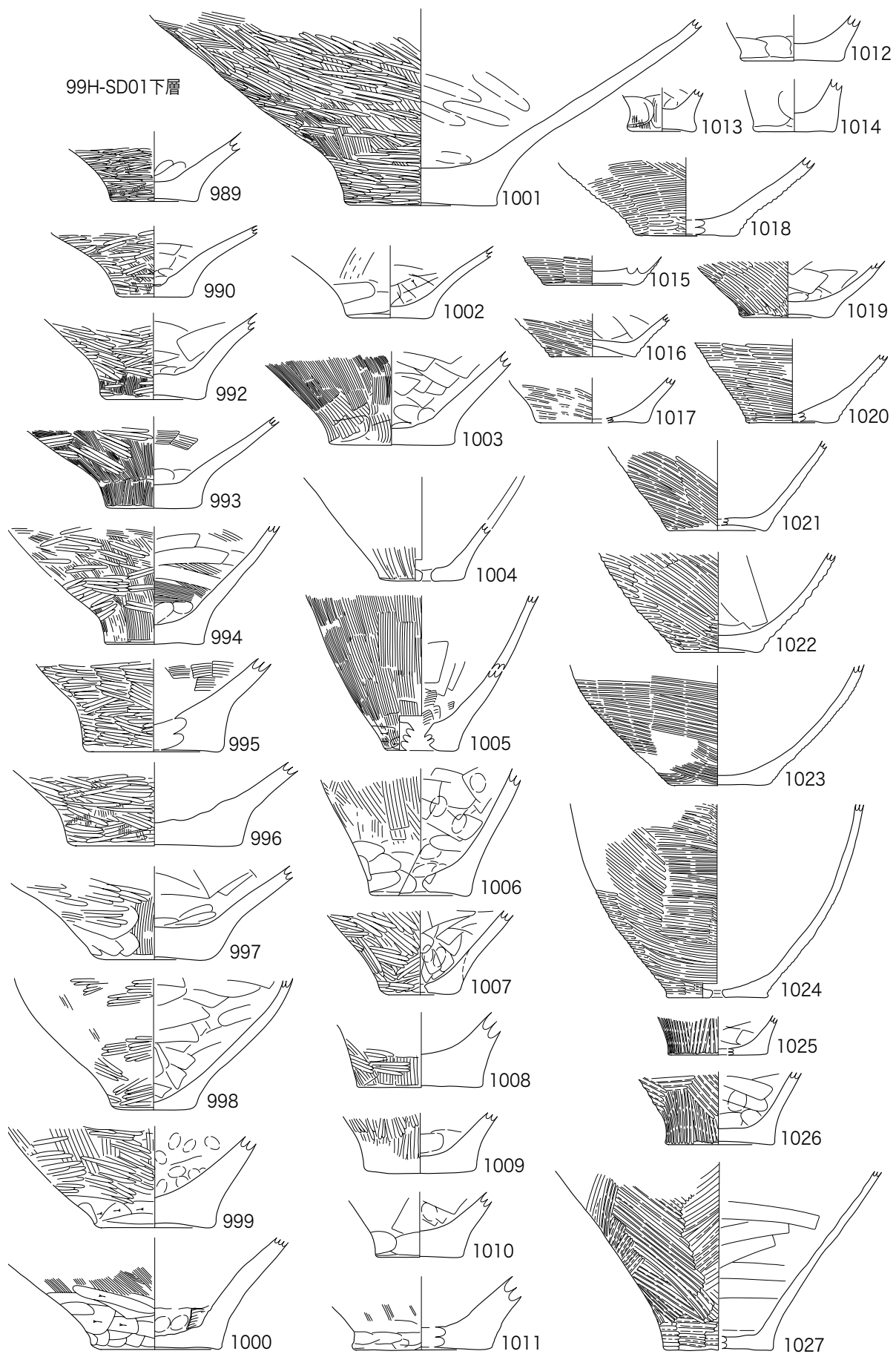

99E-SD01下層

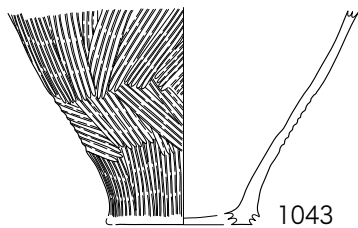
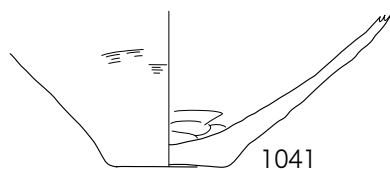
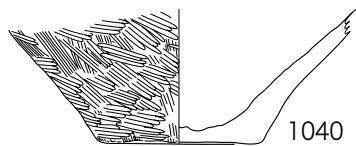
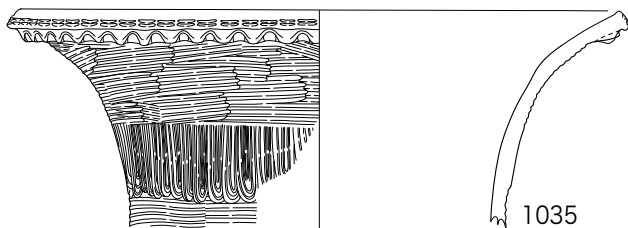
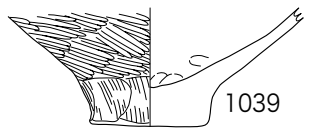
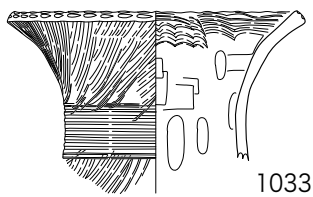
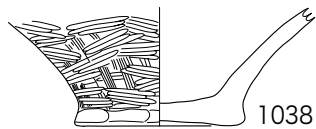
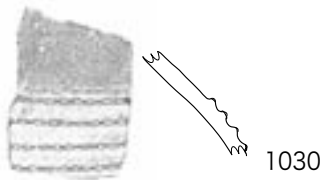
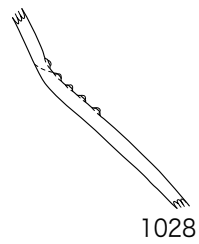
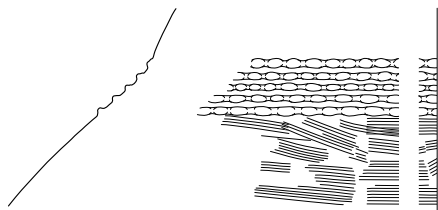

00Ac-SD01下層

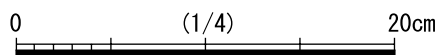
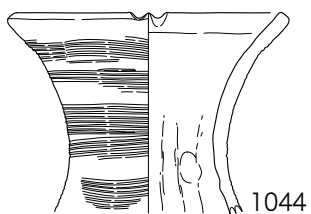

99Ca-SD16上層

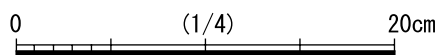
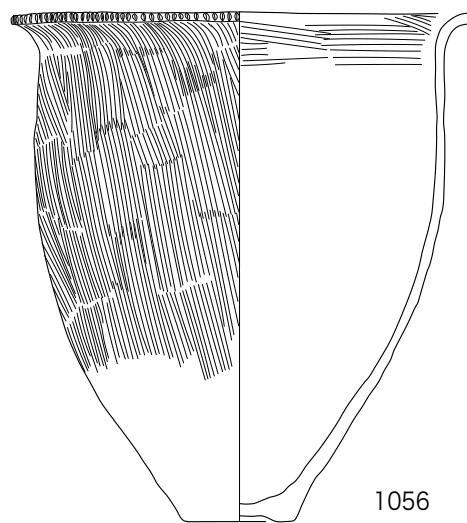
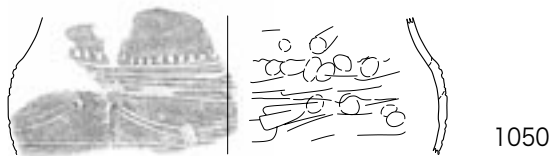
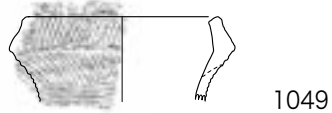
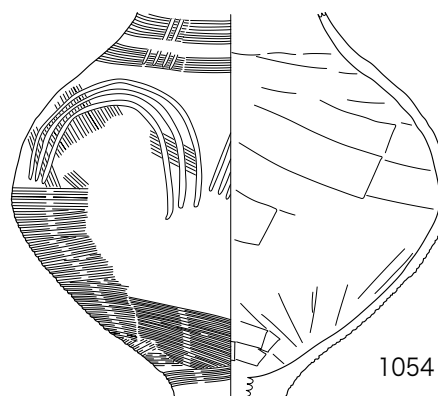
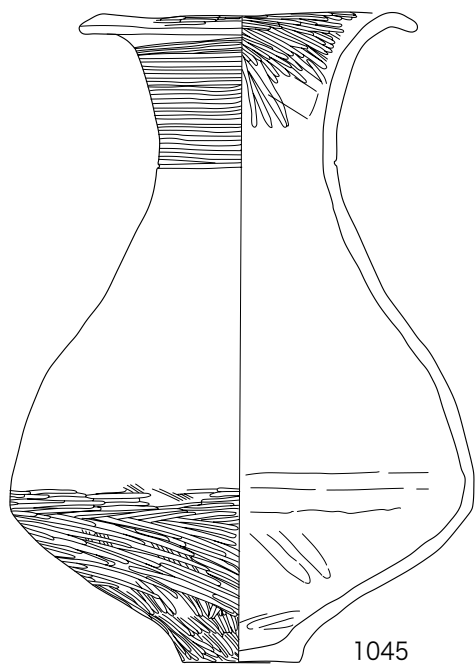

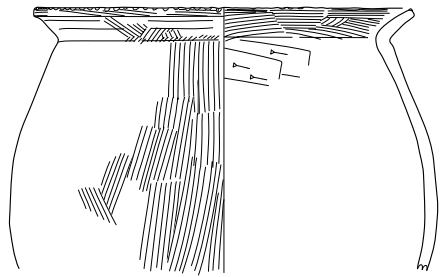

1057

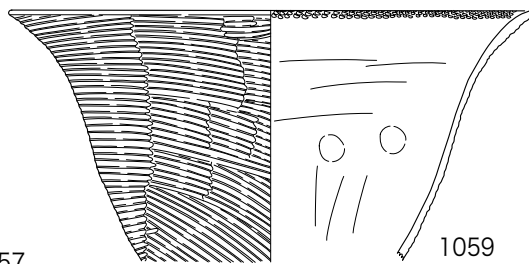

1059

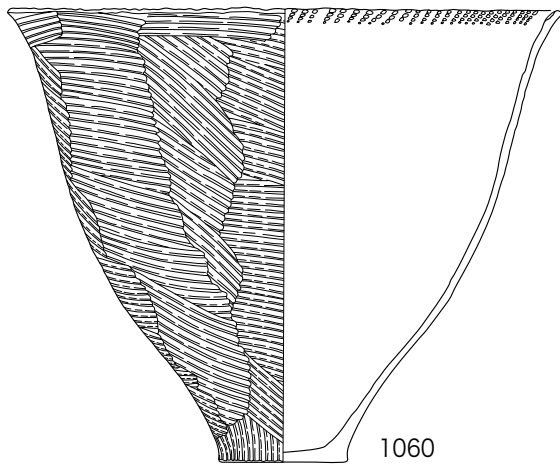

1060

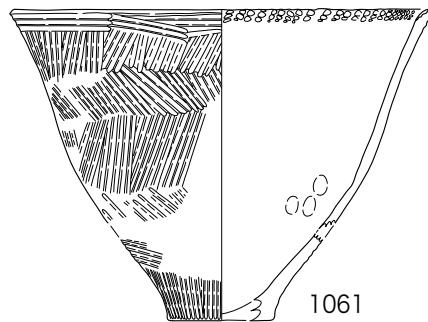

1061

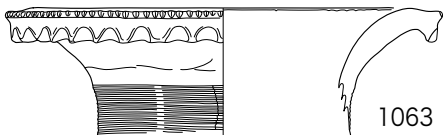

1063



1067

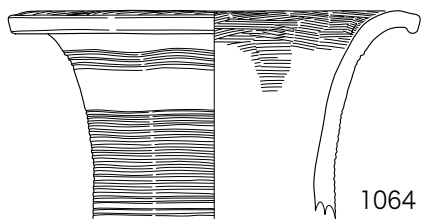

1064

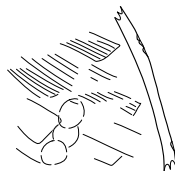

1069

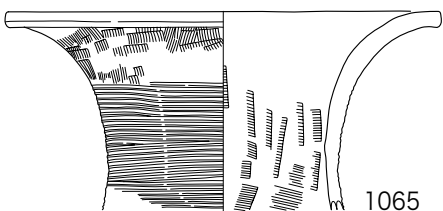

1065

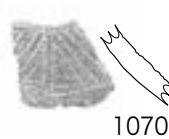

1070



1071

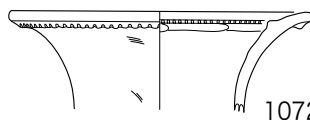

1072

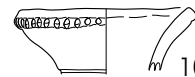

1073

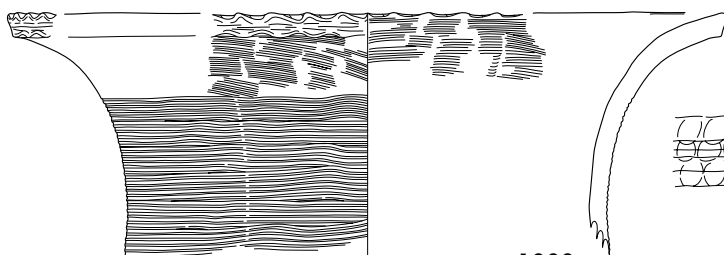

1066



1074

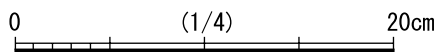

99Cb-SD16上層

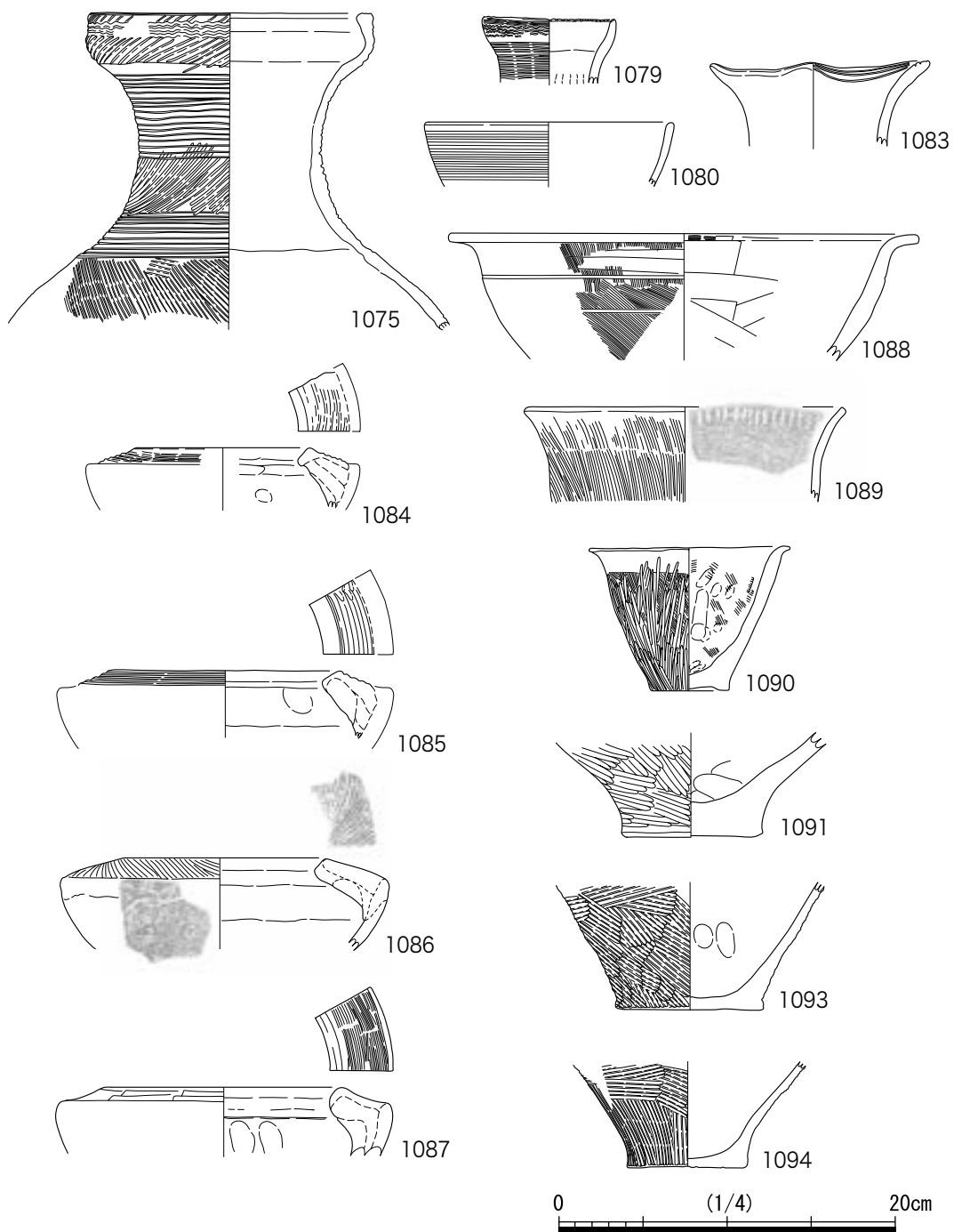

99Cb-SD16上層

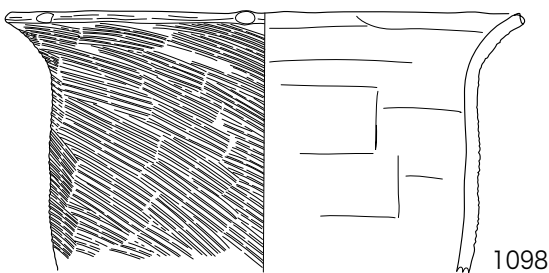
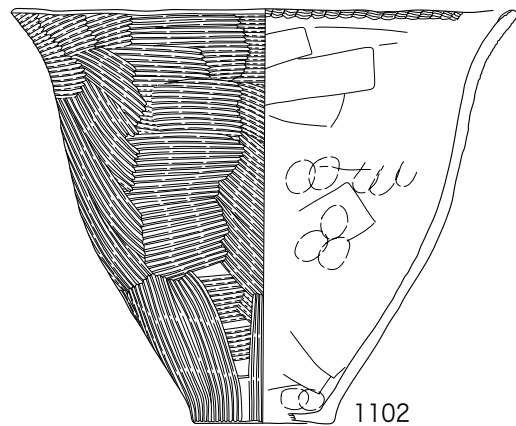
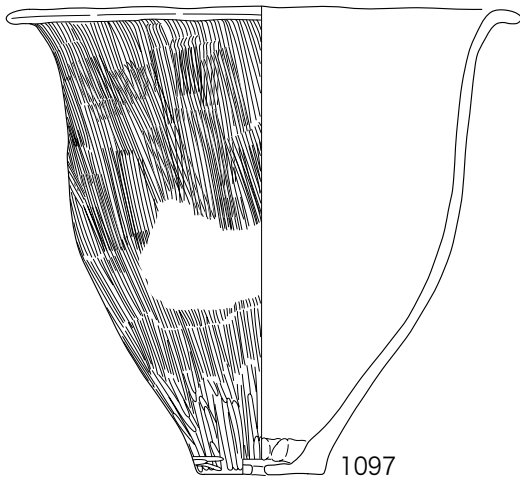
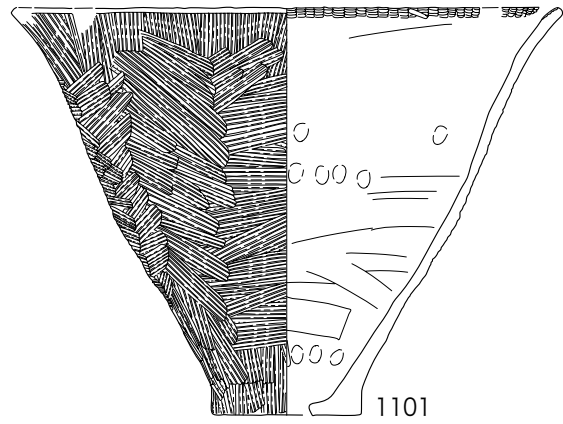
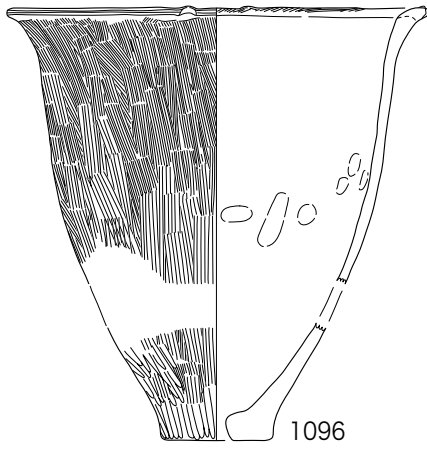
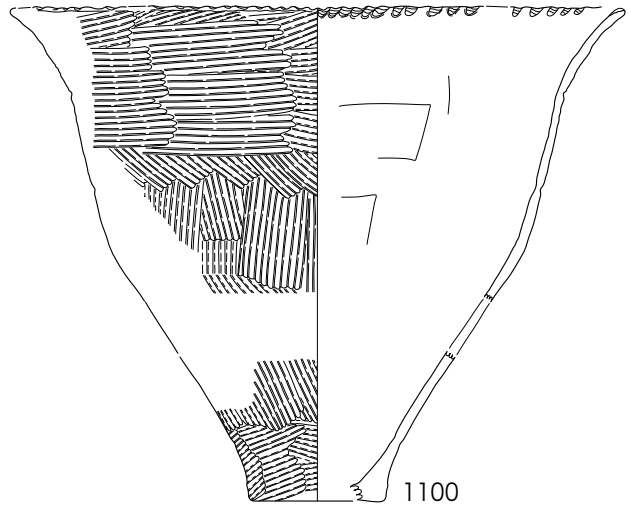
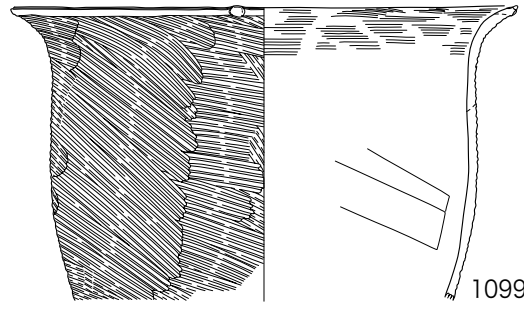
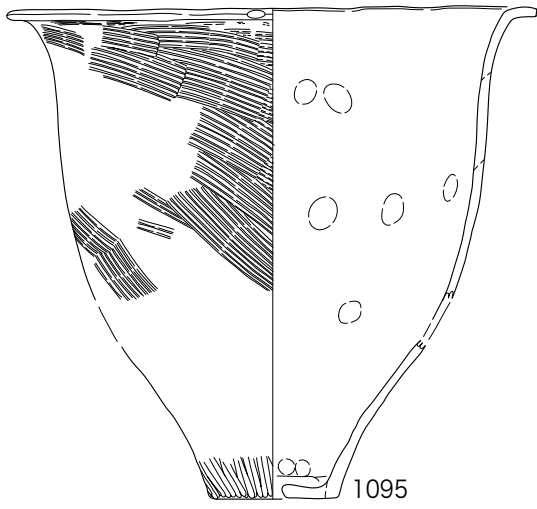

0 (1/4) 20cm

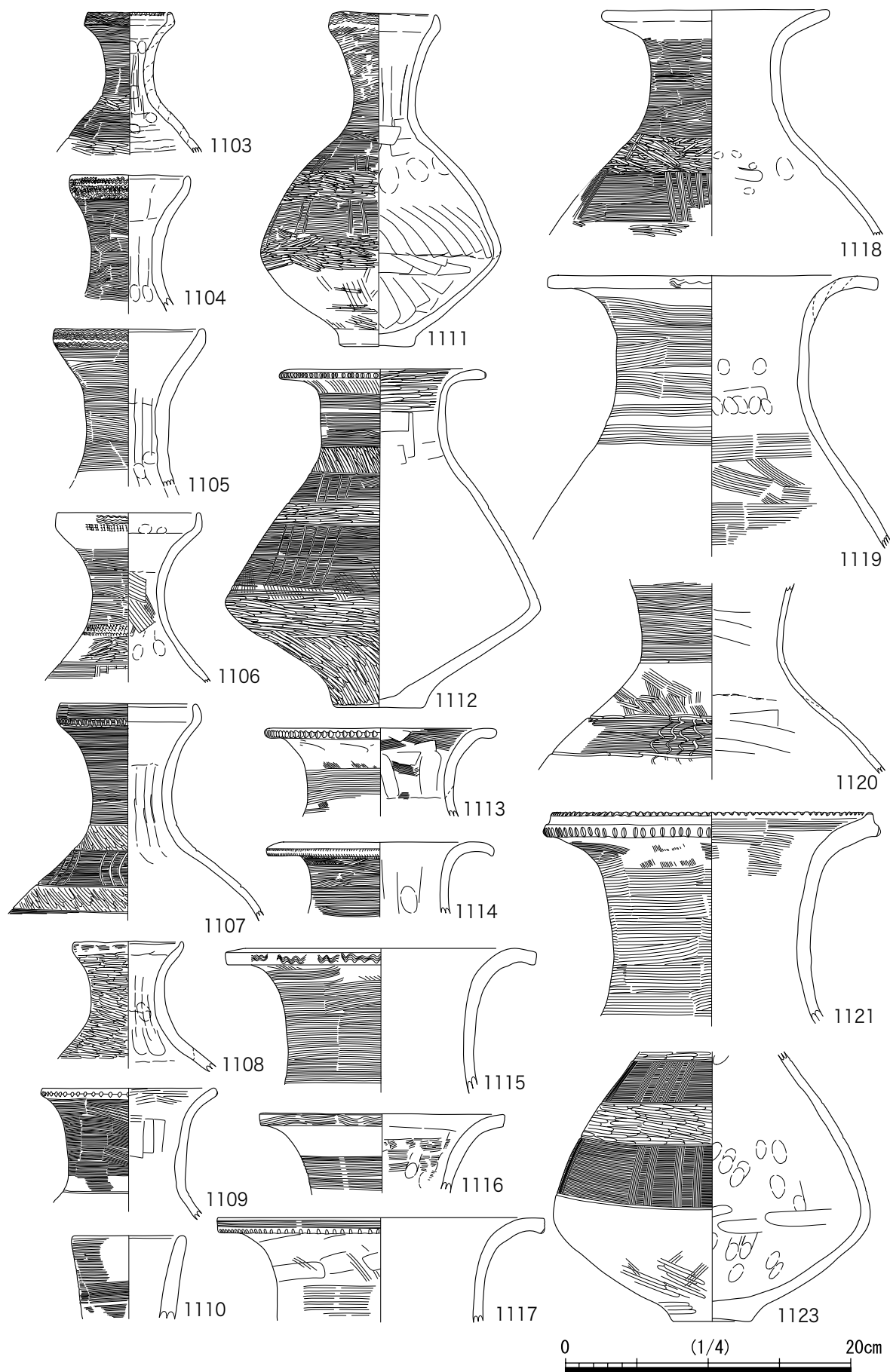

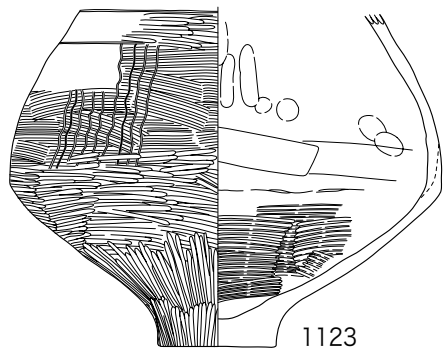

1123

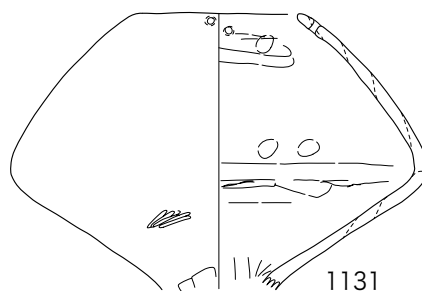

1131

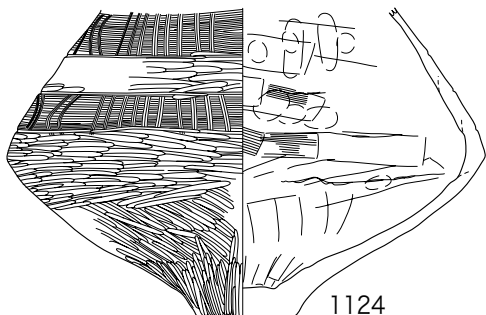

1124

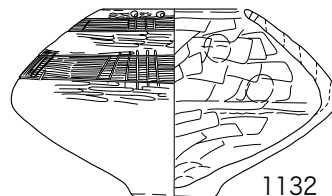

1132

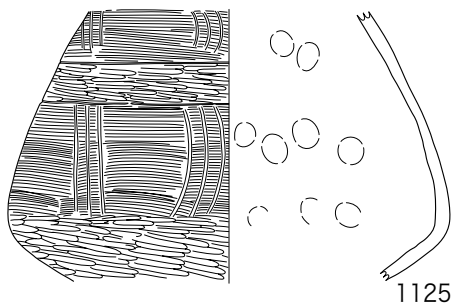

1125

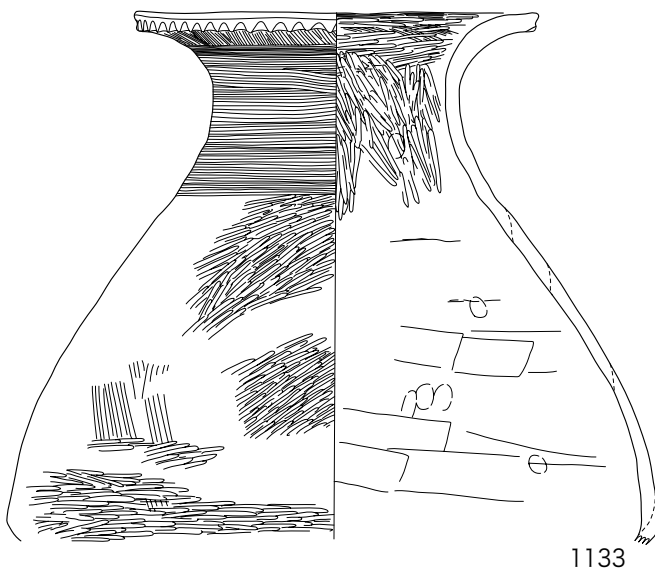

1133

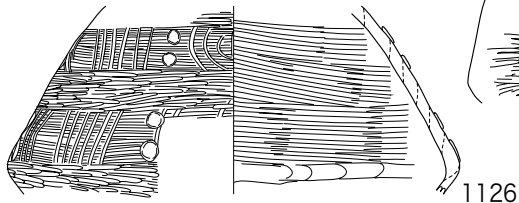

1126

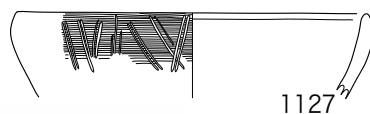

1127



1128



1129

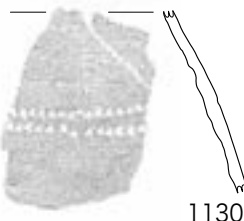

1130

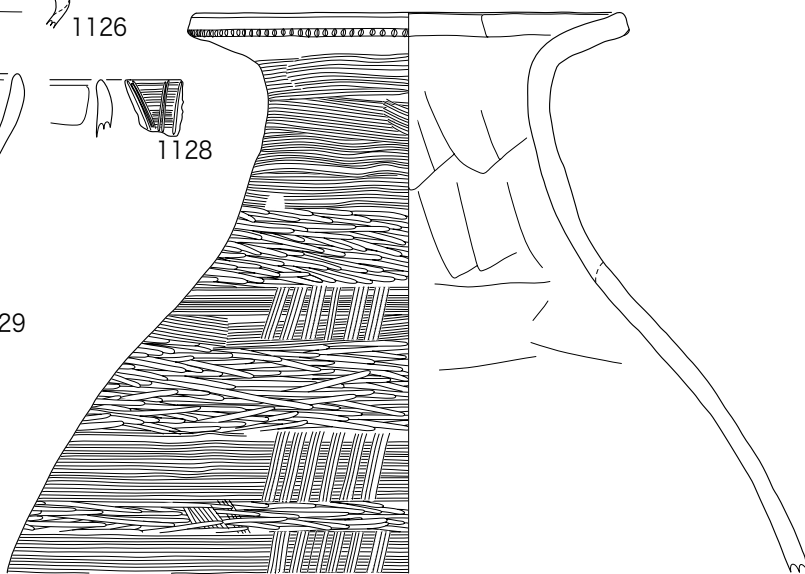

1134

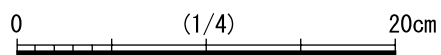

99H-SD01上層

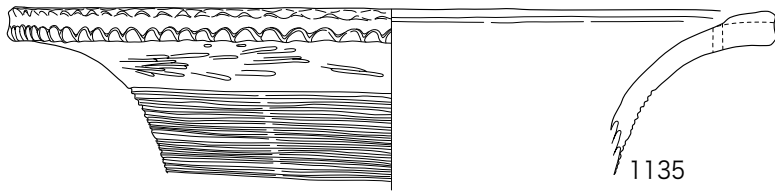

1135

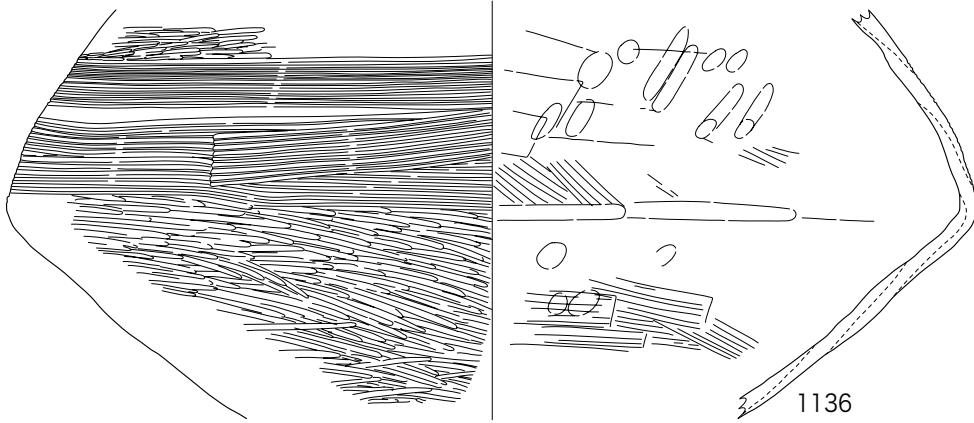

1136

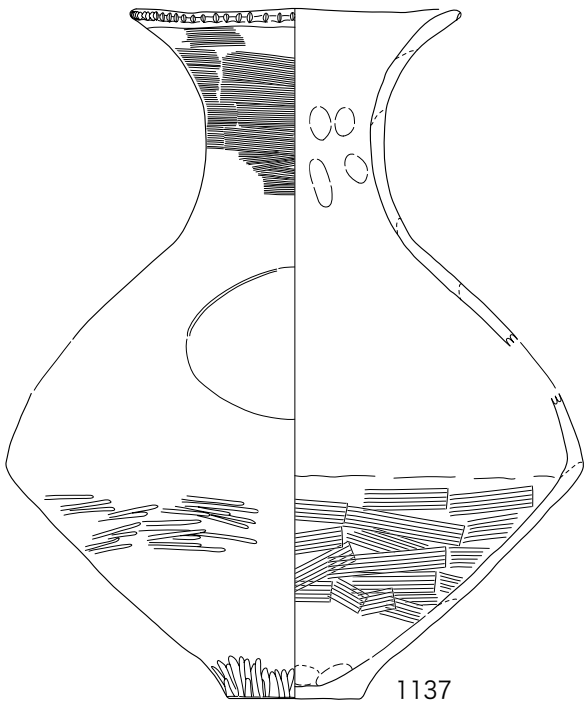

1137

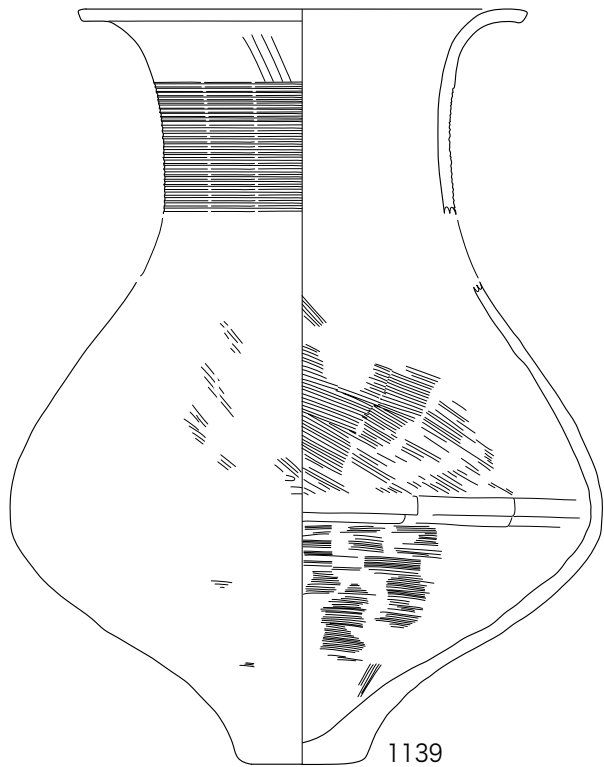

1139

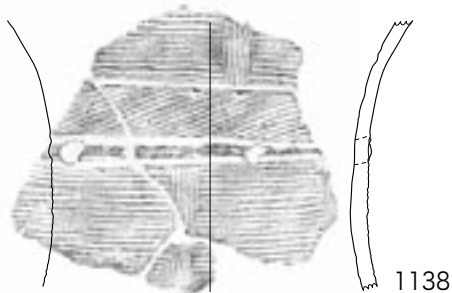

1138

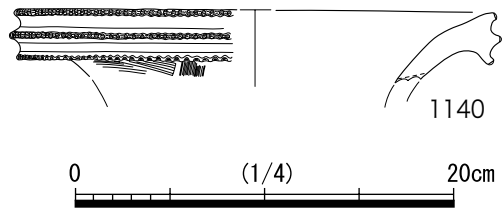

1140

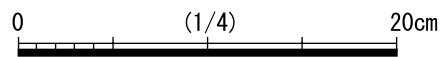

99H-SD01上層

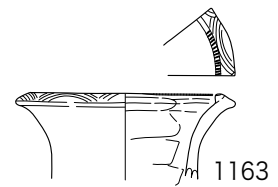
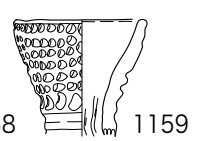
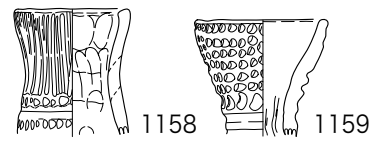
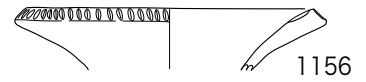
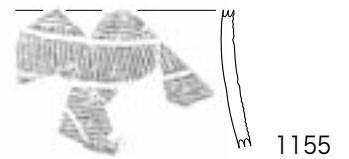
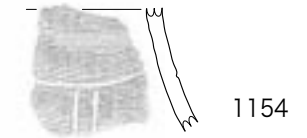
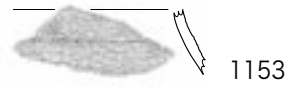
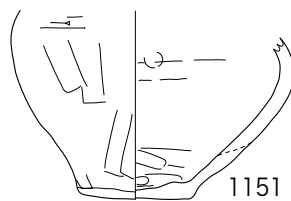
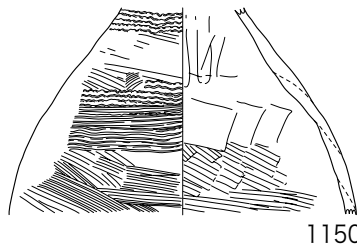
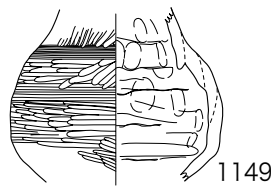
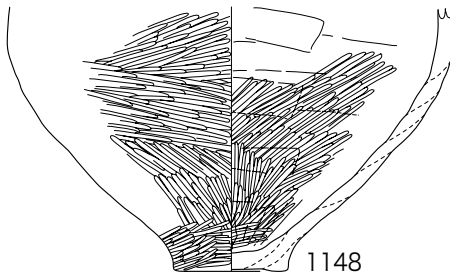
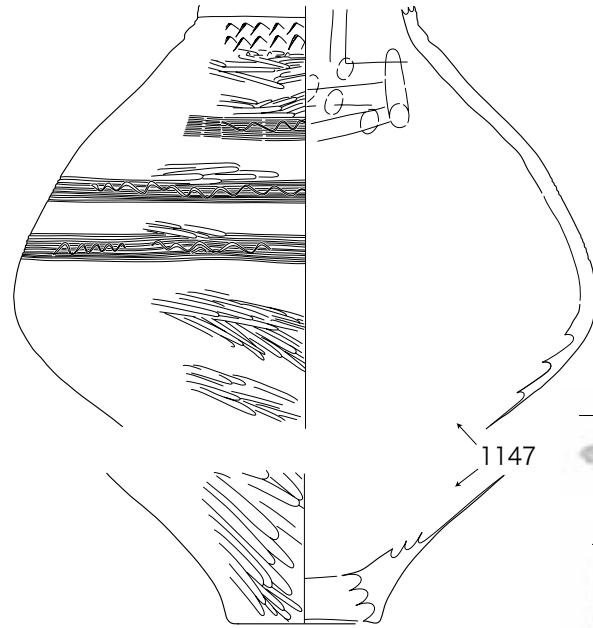
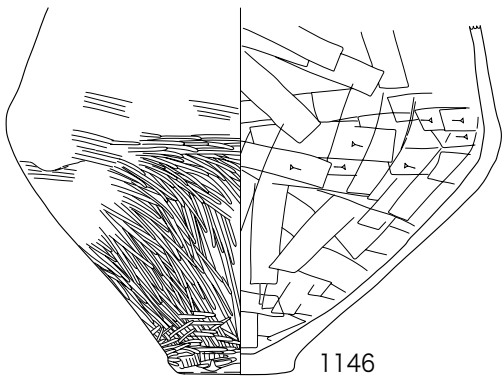
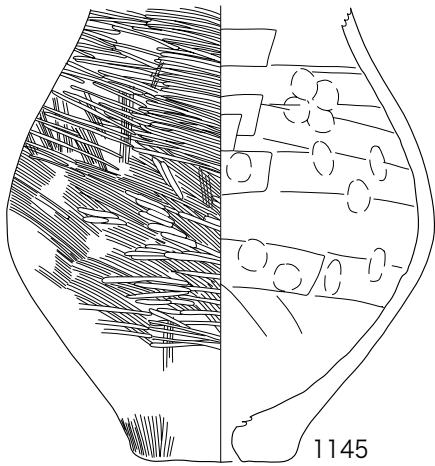
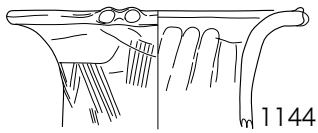
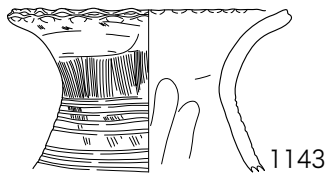
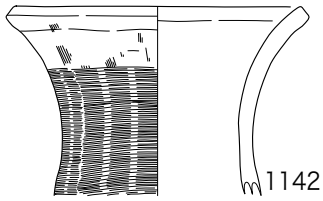
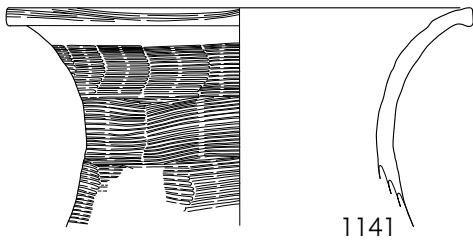

0 (1/4) 20cm

99HSD01上層

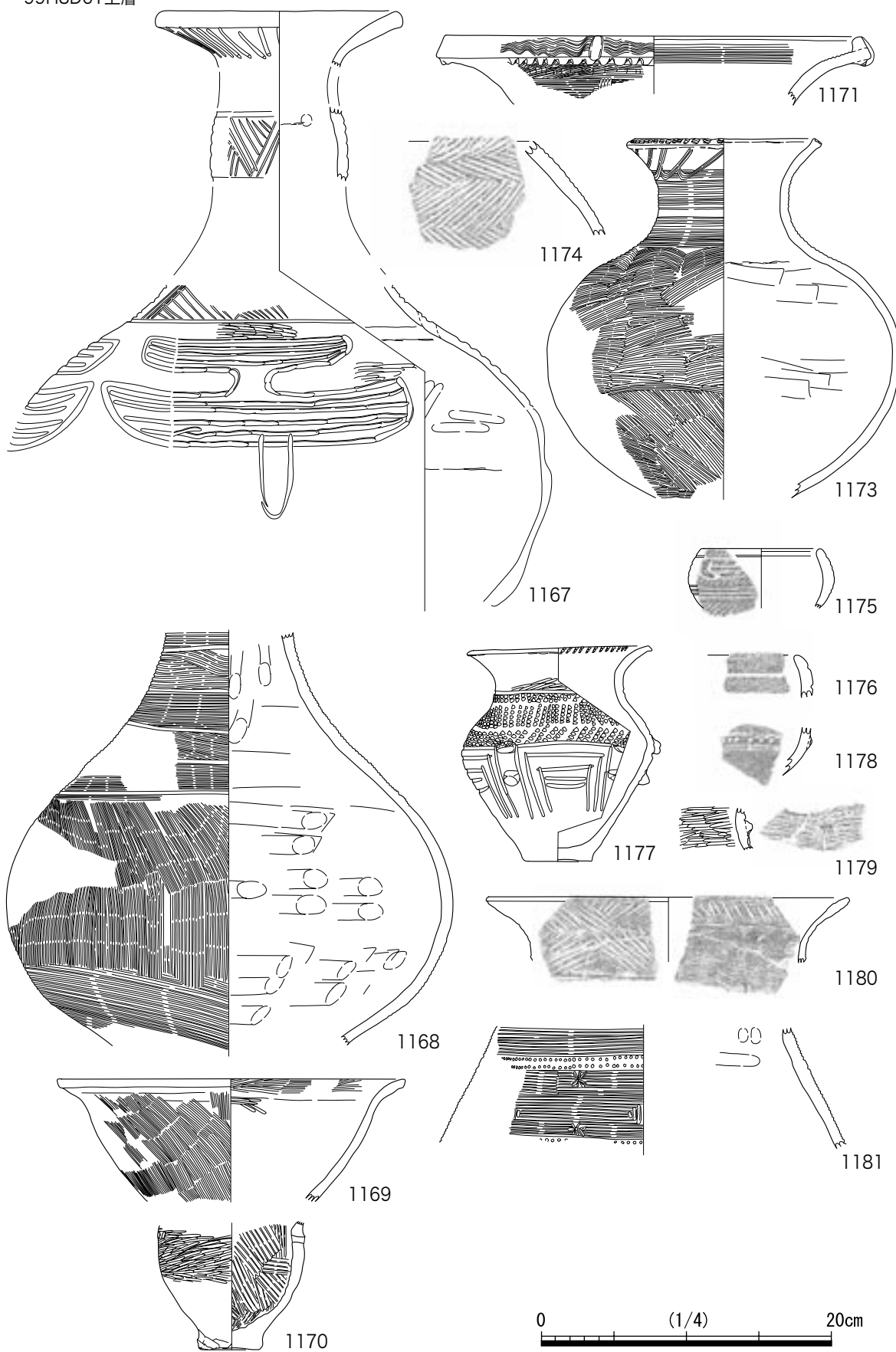

99H-SD01上層

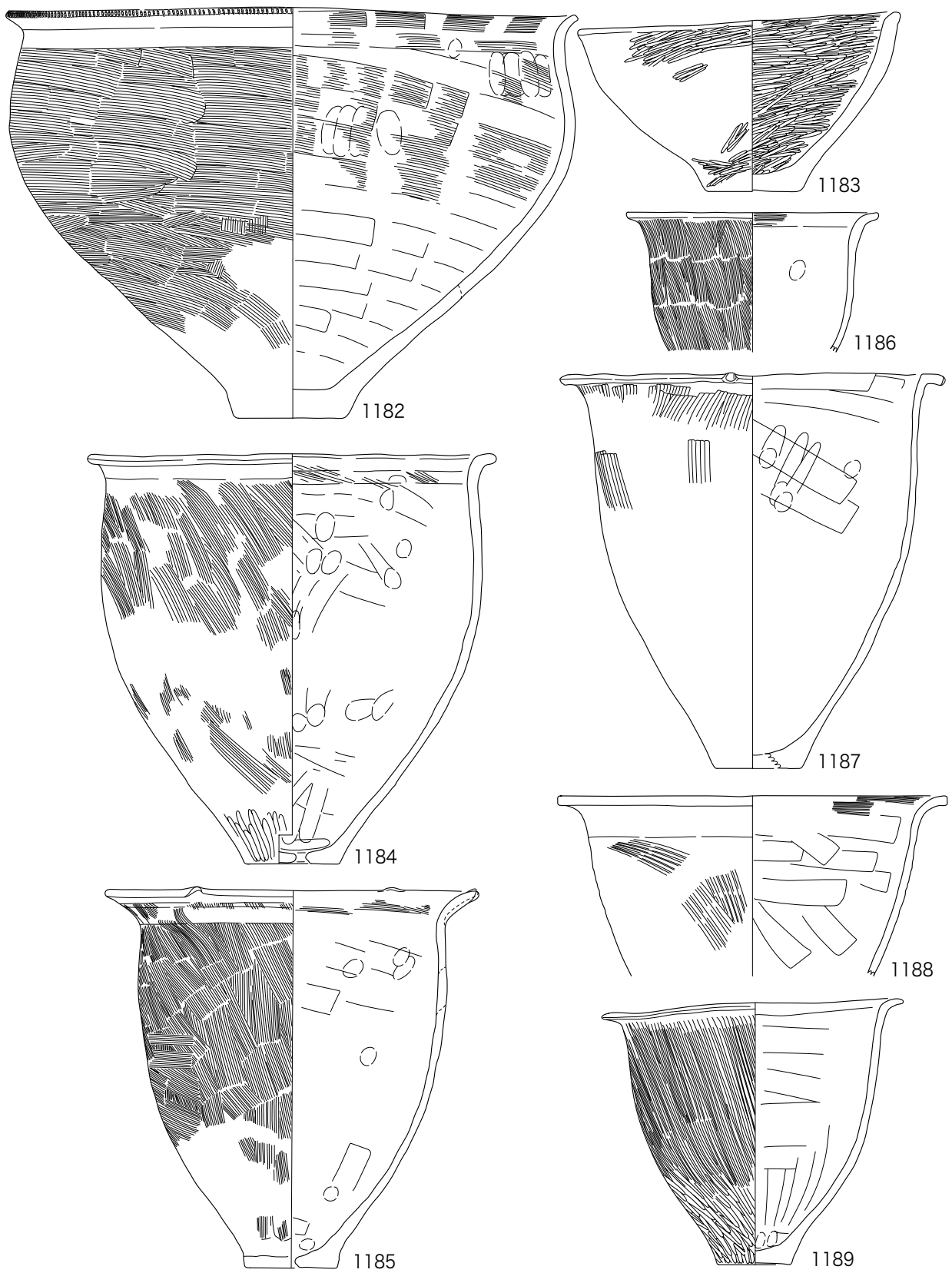

0 (1/4) 20cm

99H-SD01上層

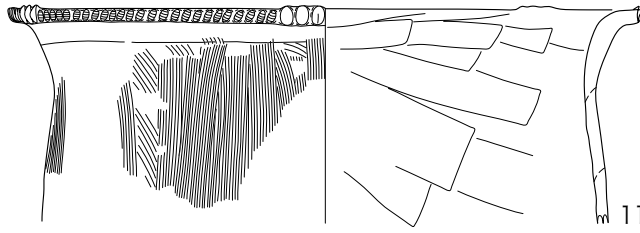

1190

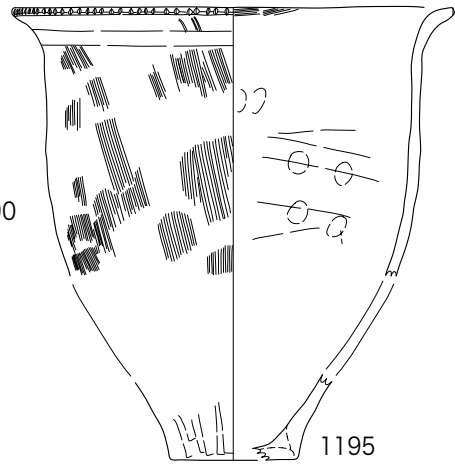

1195

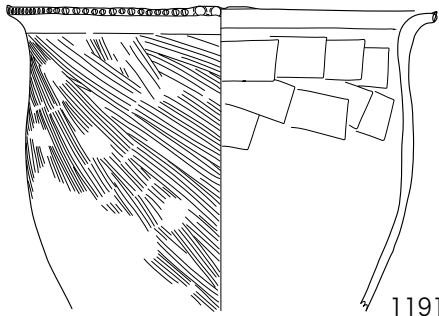

1191

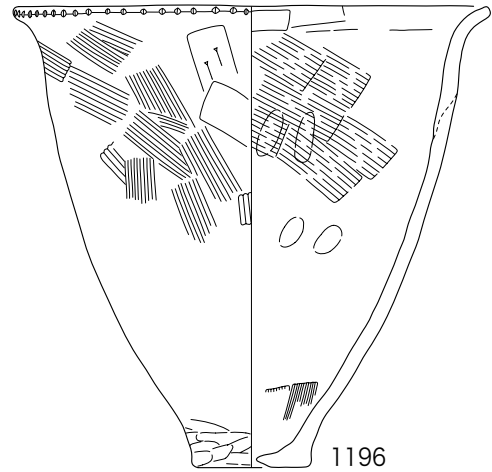

1196

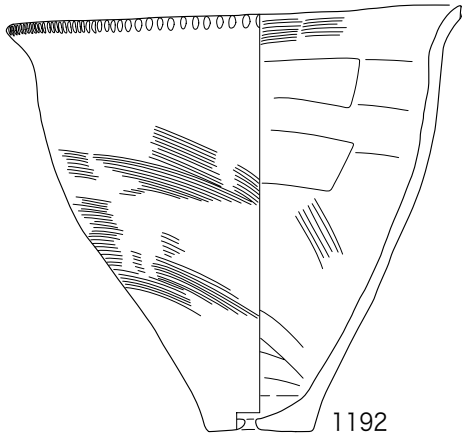

1192

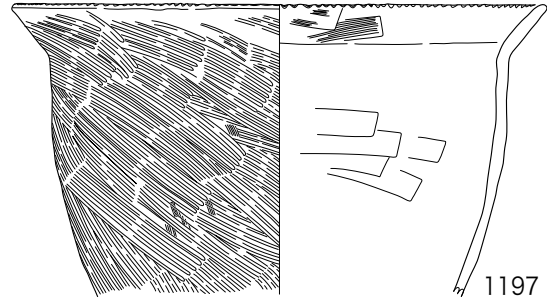

1197

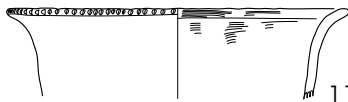

1193

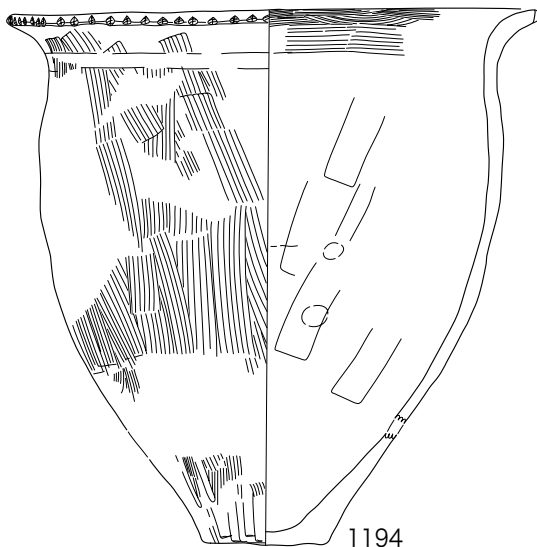

1194

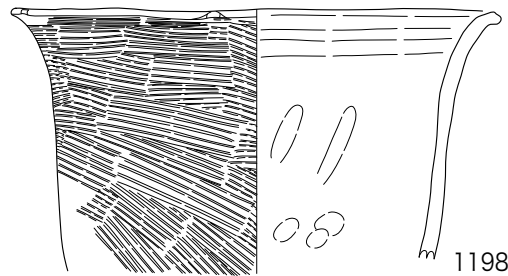

1198

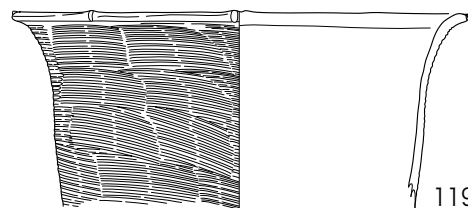

1199

0 (1/4) 20cm

99H-SD01上層

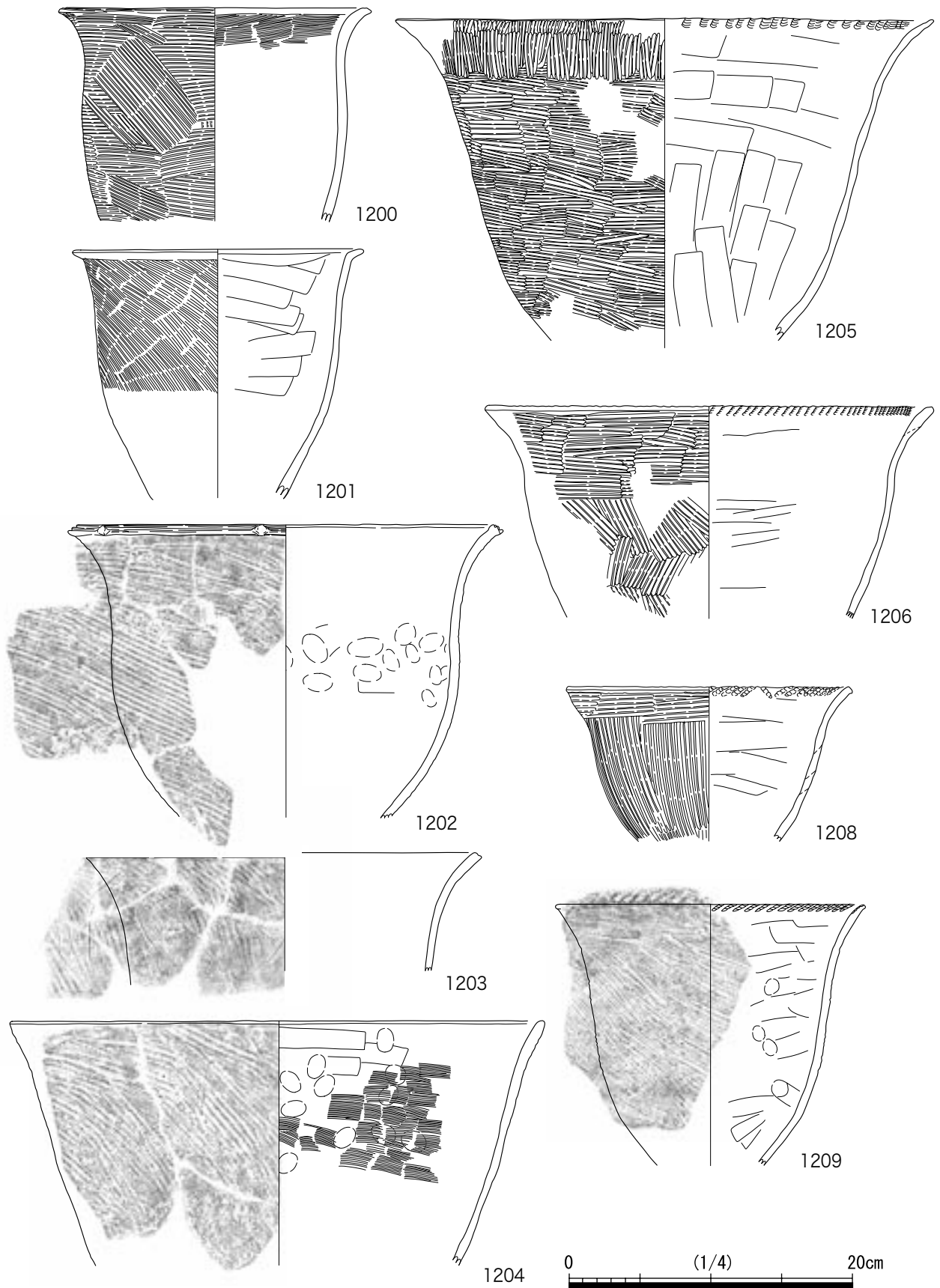

99H-SD01上層

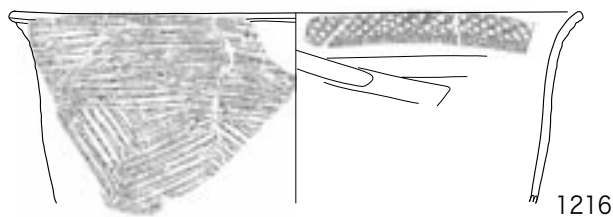
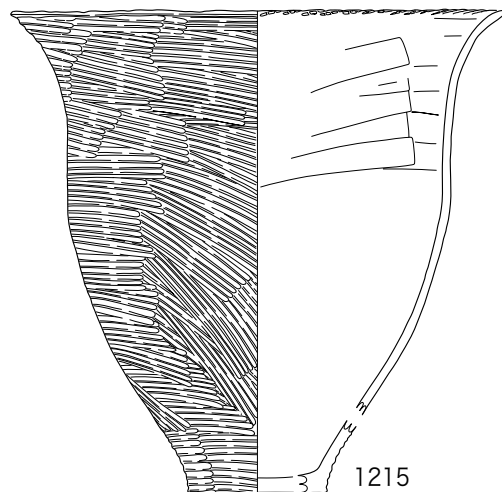
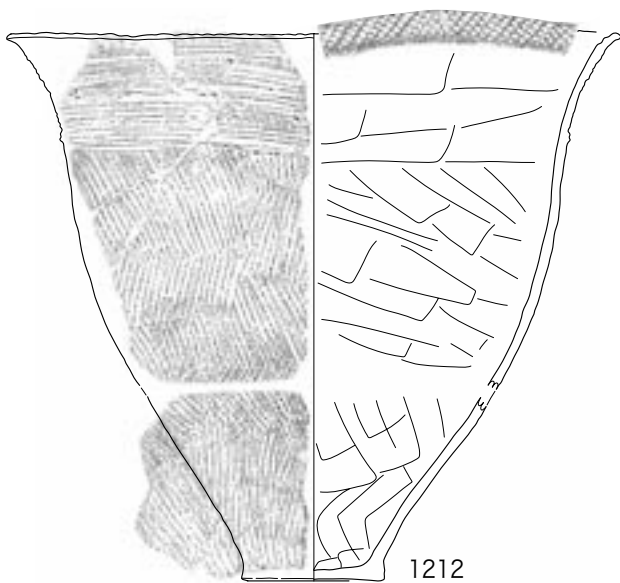
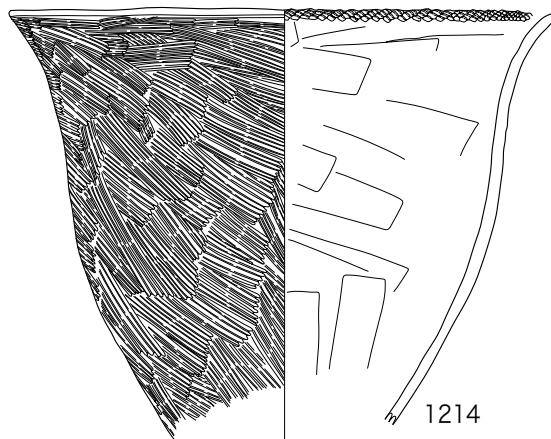
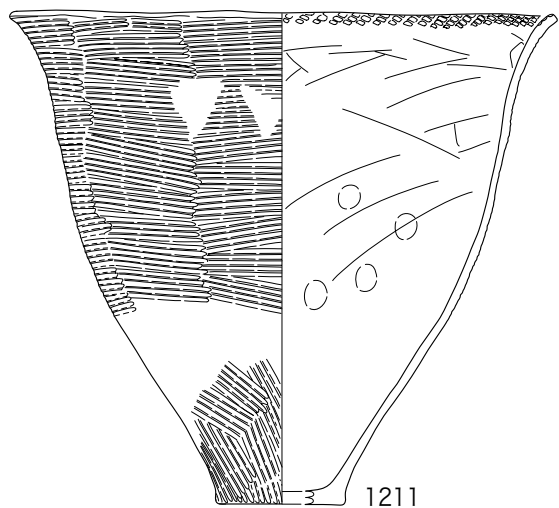
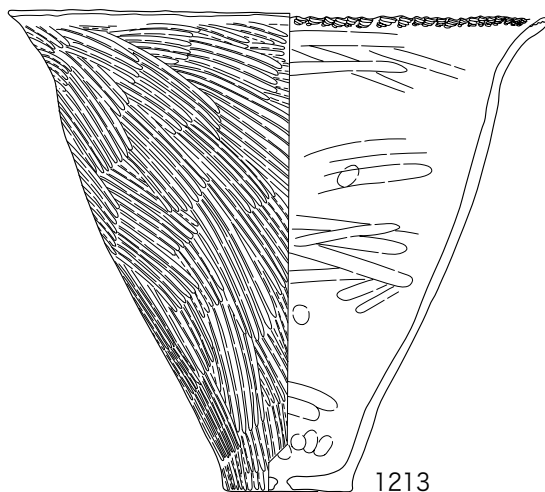
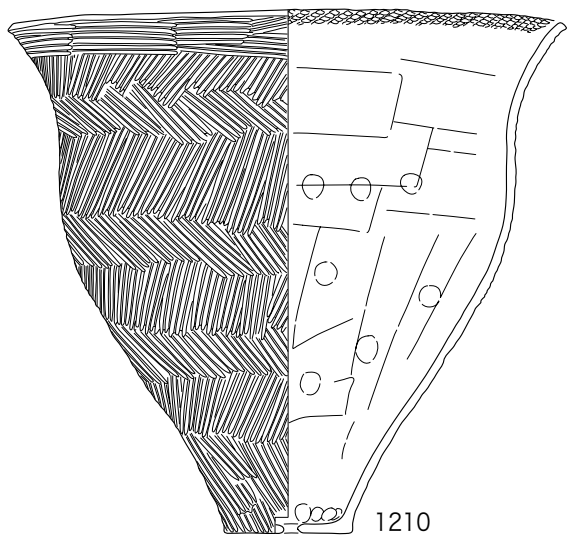

0 (1/4) 20cm

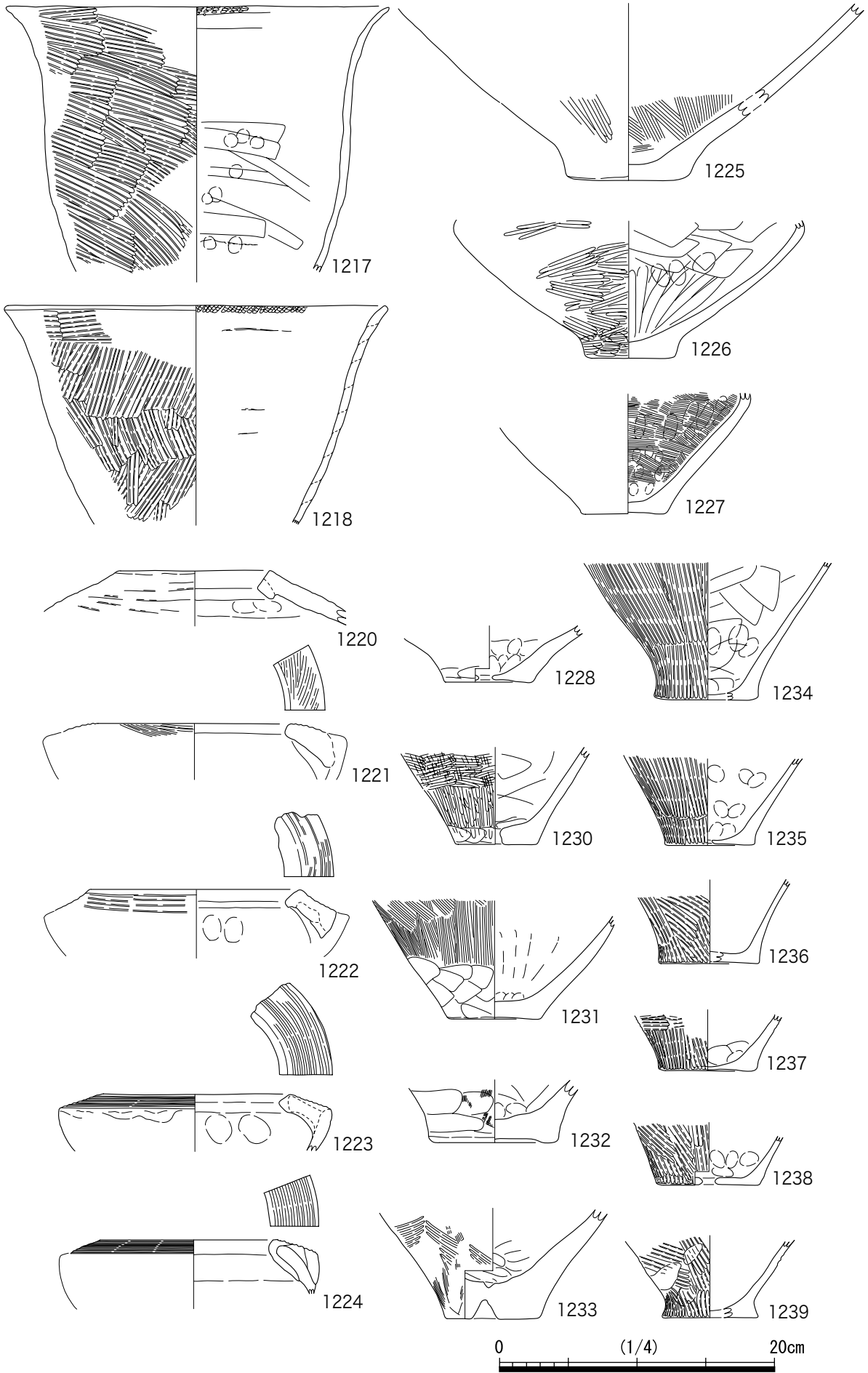

99D-SD01

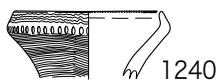

1240

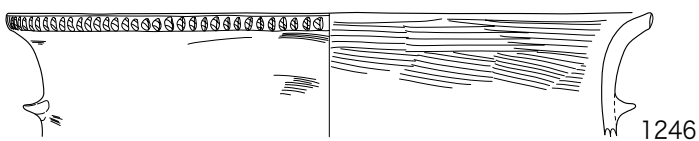

1246

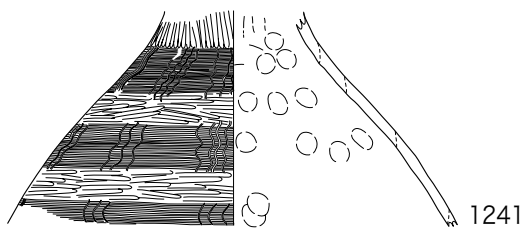

1241

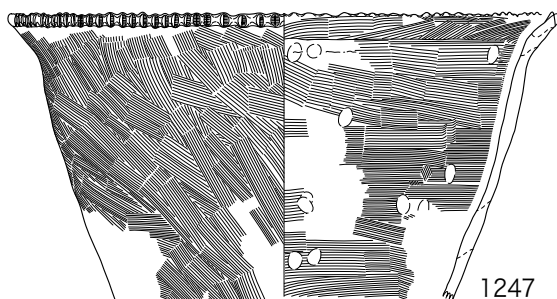

1247

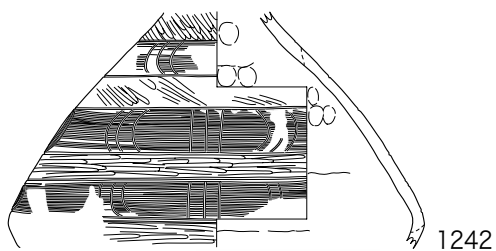

1242

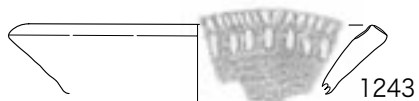

1243



1244

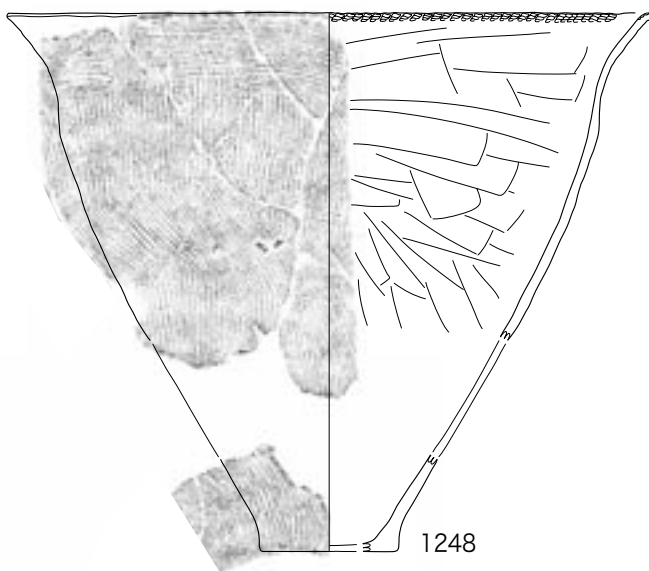

1248



1249

99E-SD01 上層

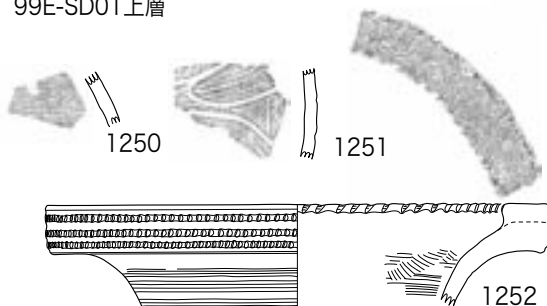

1250

1251

1252



1253



1254

1255

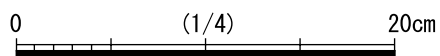

99E-SD01上層

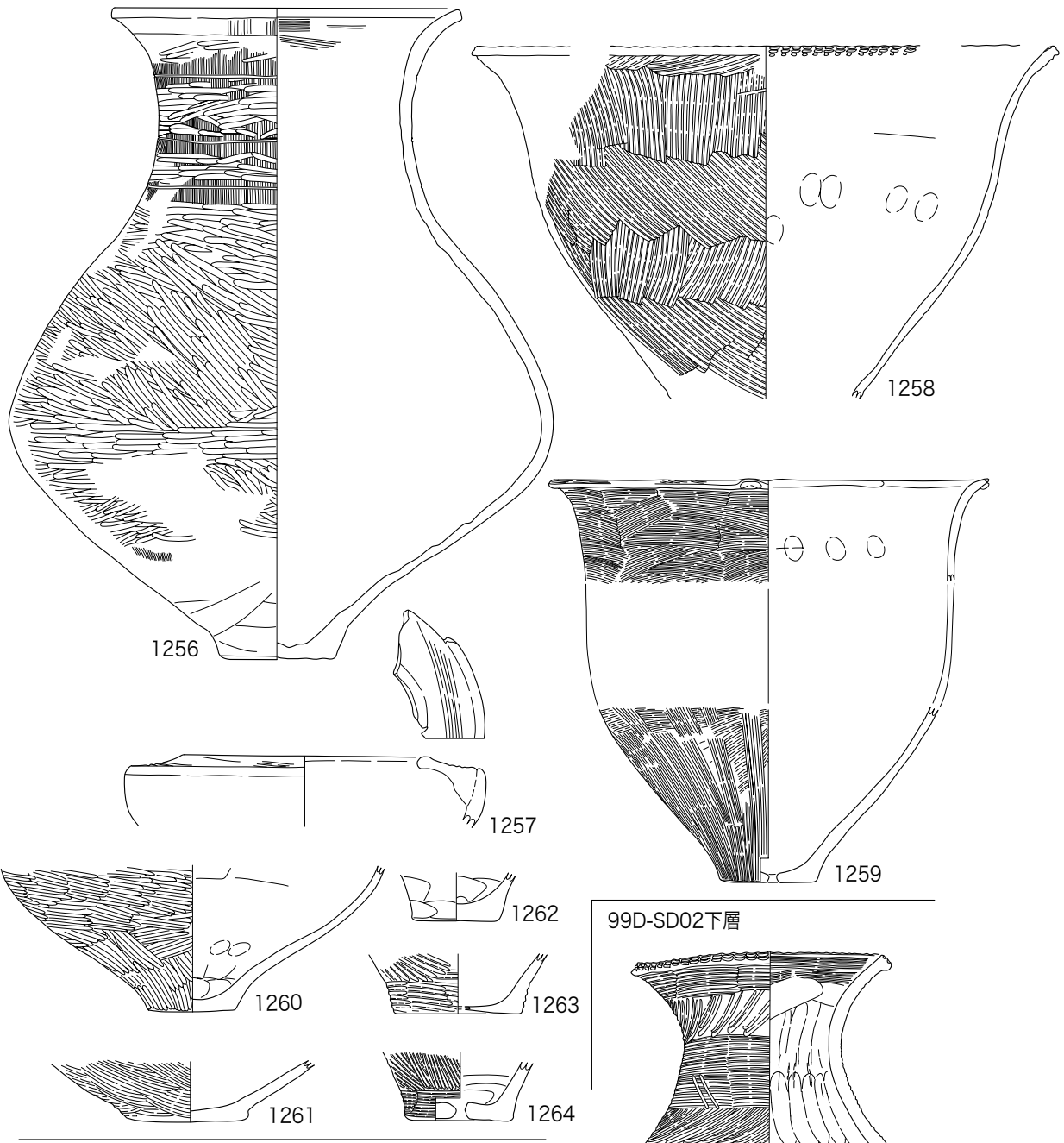

99D-SD02下層

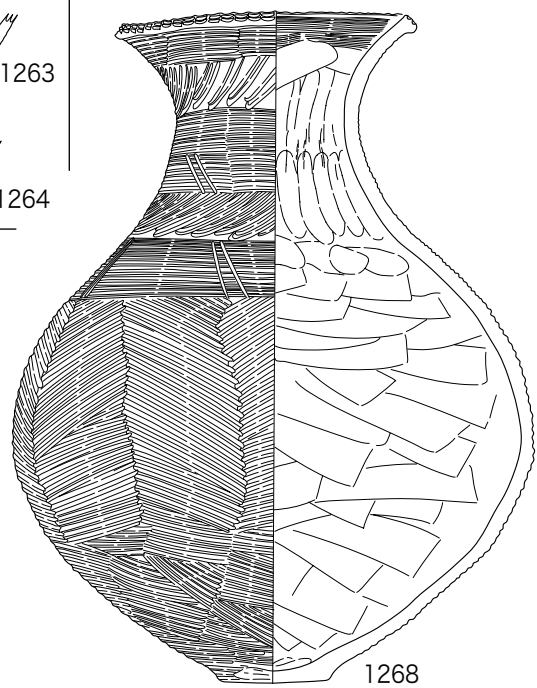

00Ac-SD01上層

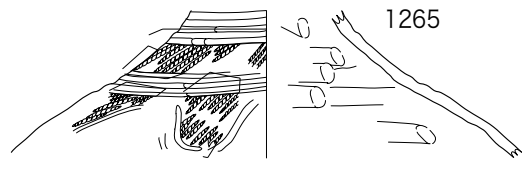

99H-SD02上層

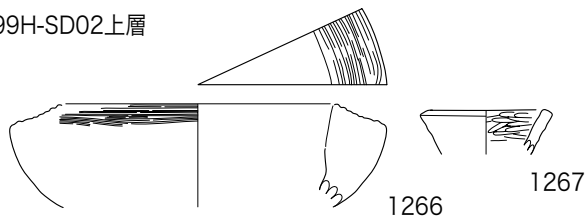

0 (1/4) 20cm

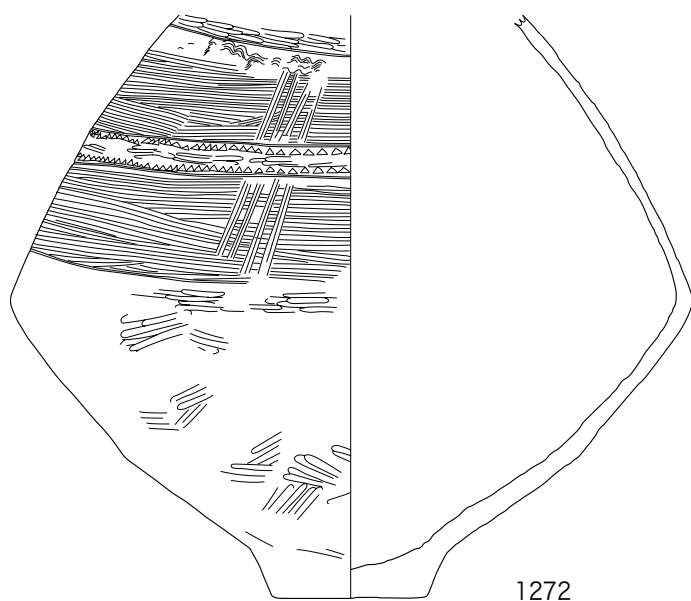
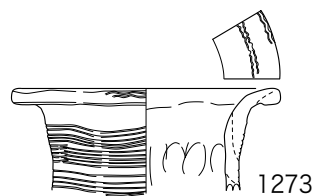
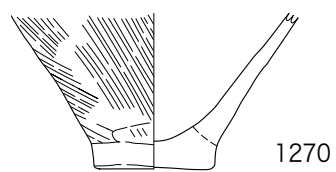
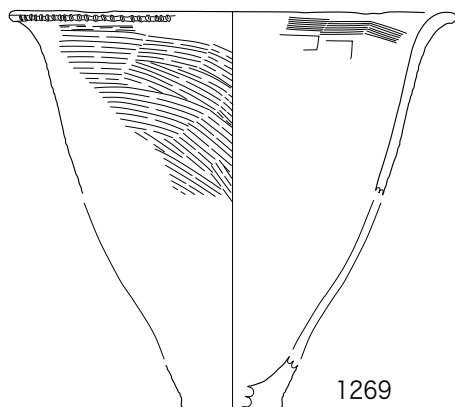

0 (1/4) 20cm

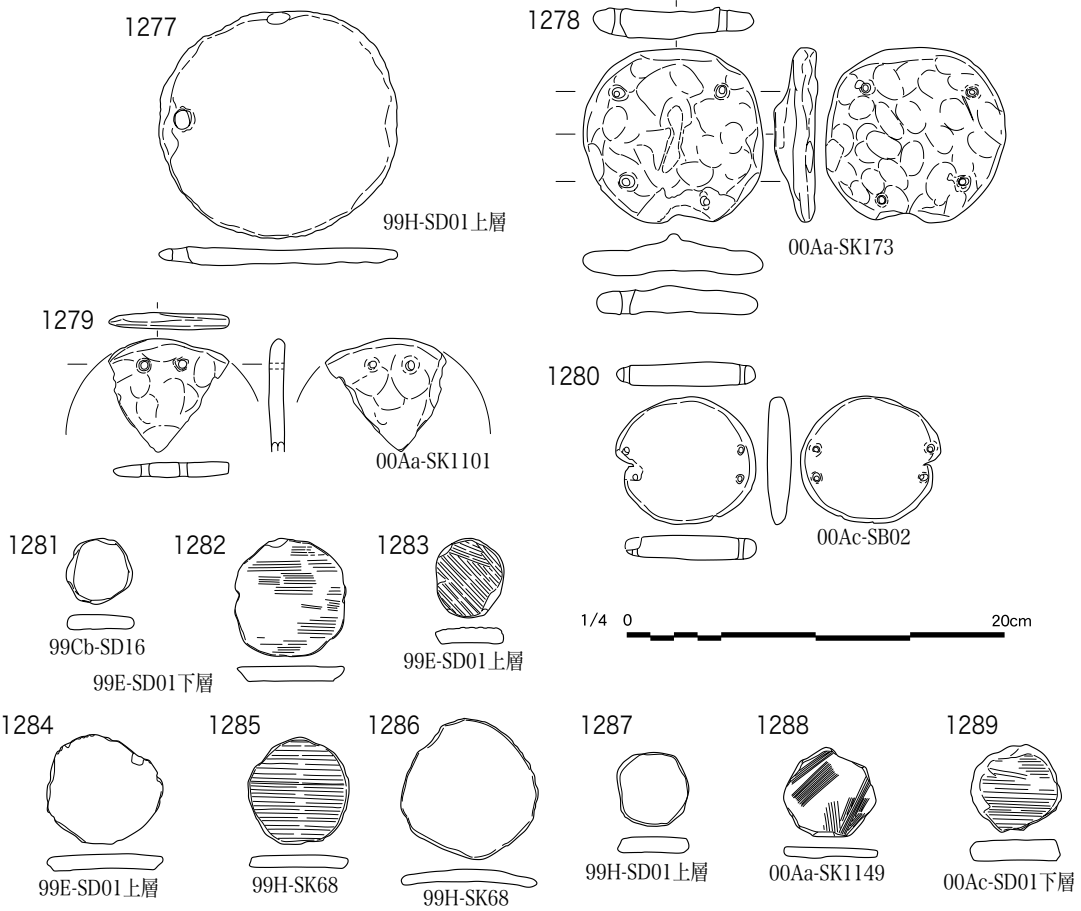
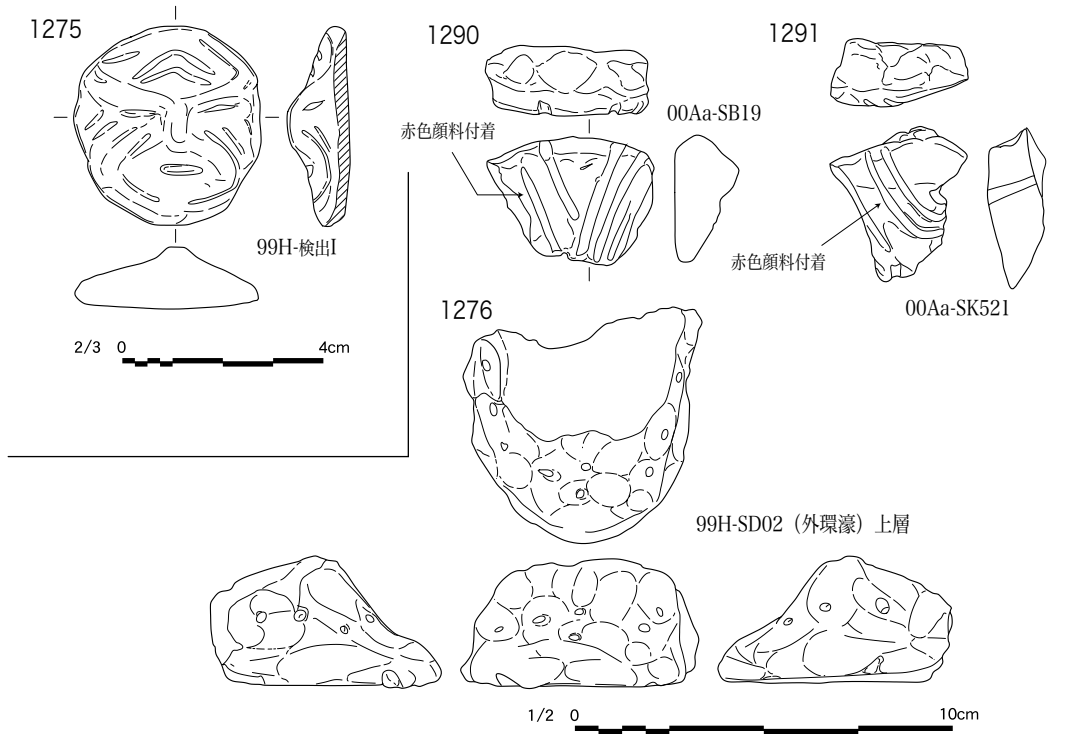

00Ab-SB03

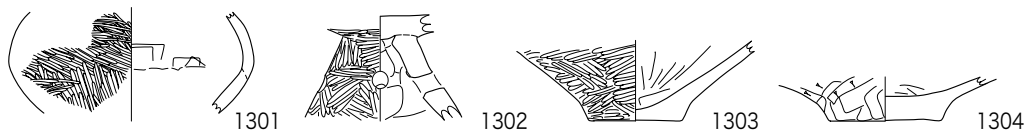

00Ab-SD38

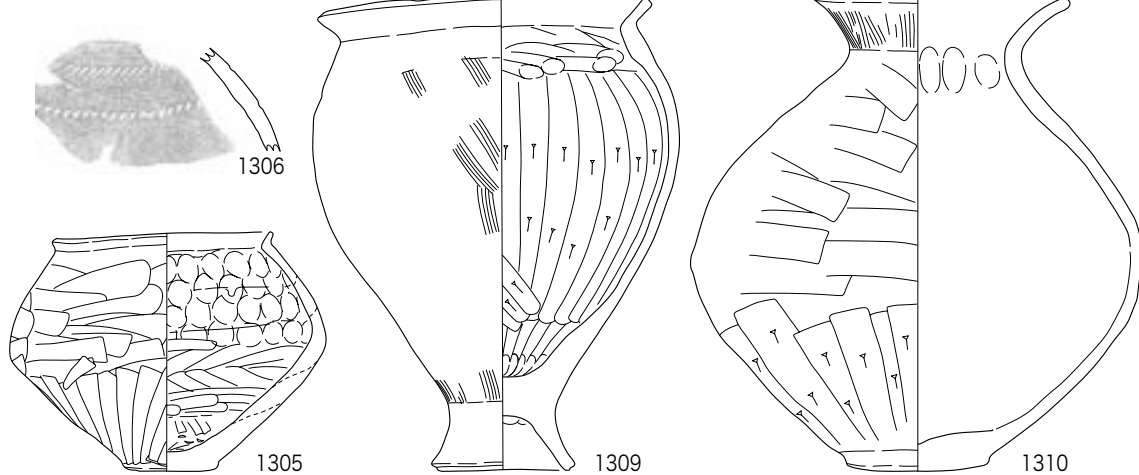

00Ab-SD42

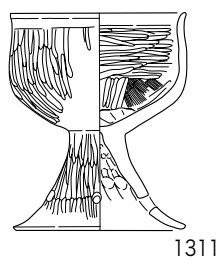

1311

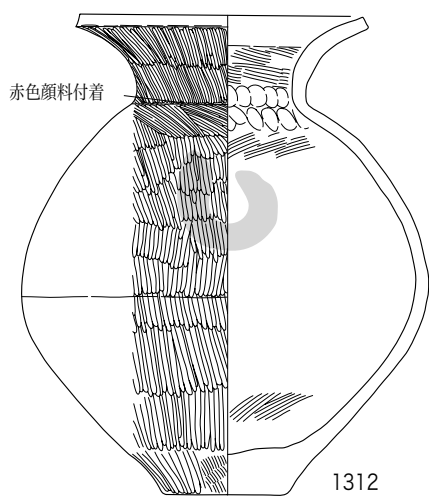

1312

99E-SK123

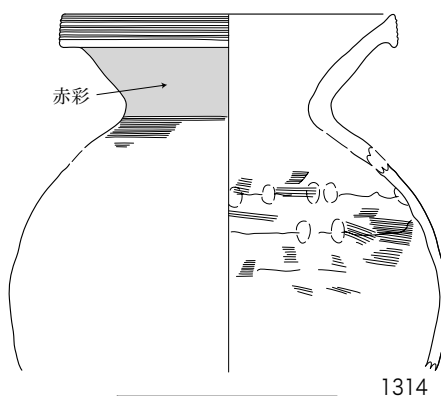

1314

00Ab-SD45

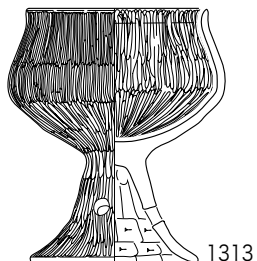

1313

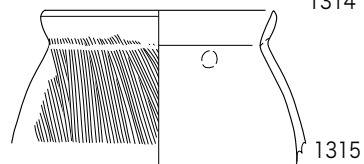

1315

00Ab-SB14

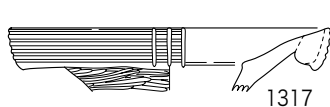

1317

00Ac-SK161

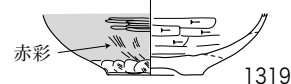

1319

99H-SK49

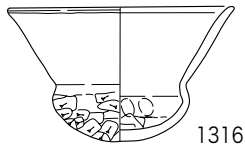

1316



1318

00AcSK203

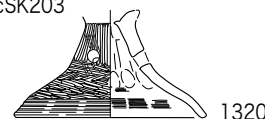

1320

1/4 0 20cm

00Ac-SK160

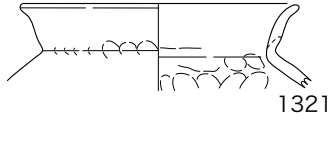

1321

99E-SK84

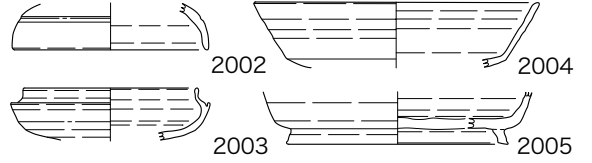

2002

2004

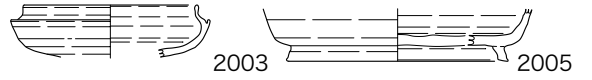

2003

2005

00Ab-SB05

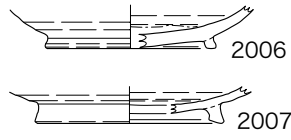

2006

2007

00Ab-SB07

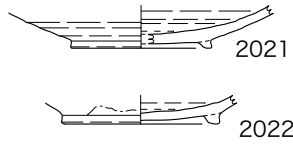

2021

2022

00Ab-SB08

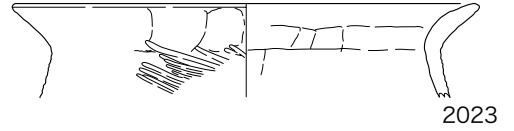

2023

00Ab-SB06

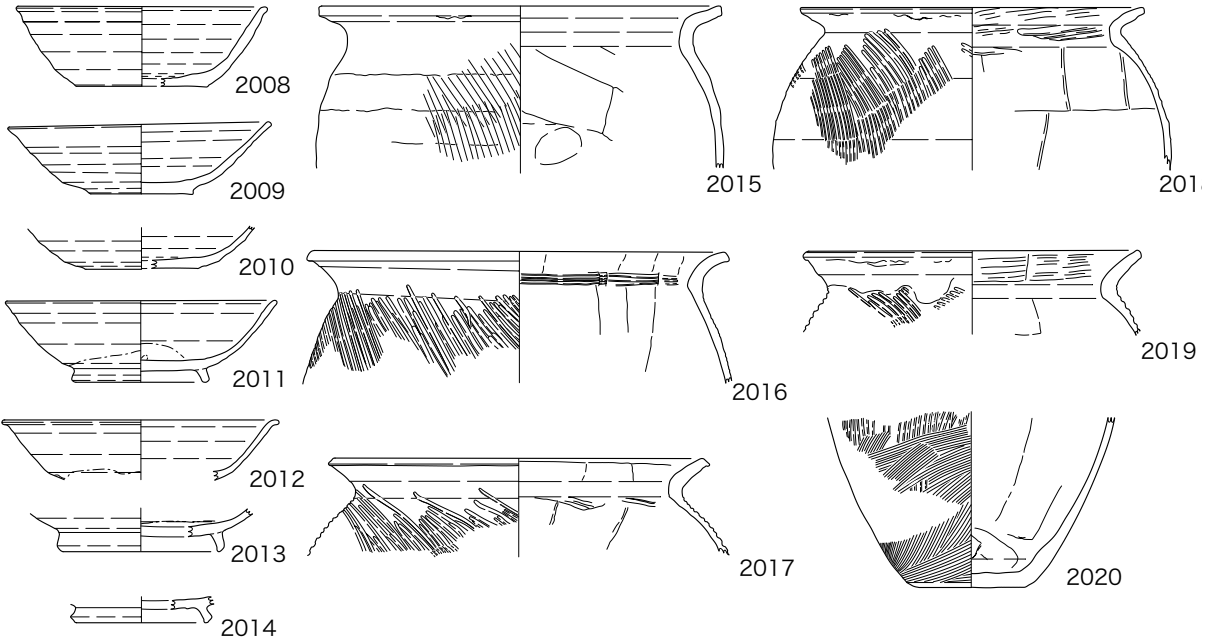

2008

2009

2010

2011

2012

2013

2014

2015

2016

2017

201

2019

2020

99B-SE01

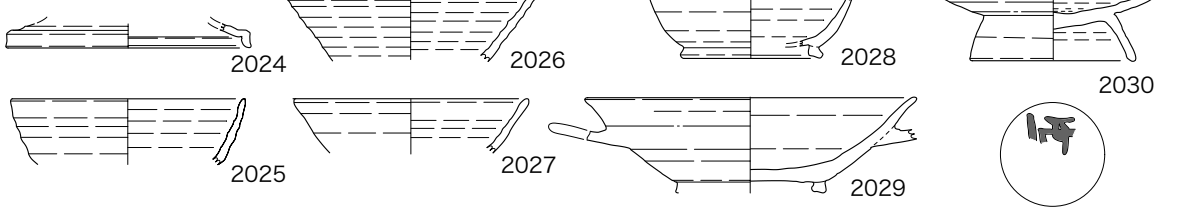

2024

2026

2028

2030

2025

2027

2029

99Cb-SE02



2031

2032

99E-SD08



2033

99Cb-SD16



2034

99E-SD22

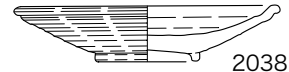

2038

99H-SD17

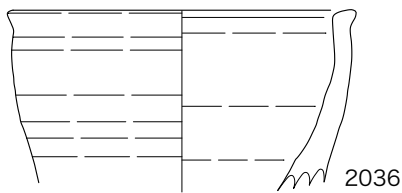

2036

00Aa-SD16



2035

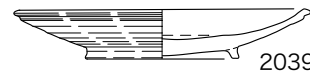

2039

99B·Ca-SD20

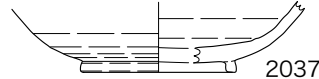

2037

99E-SD28

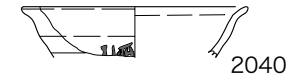

2040

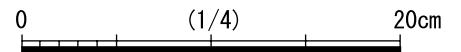

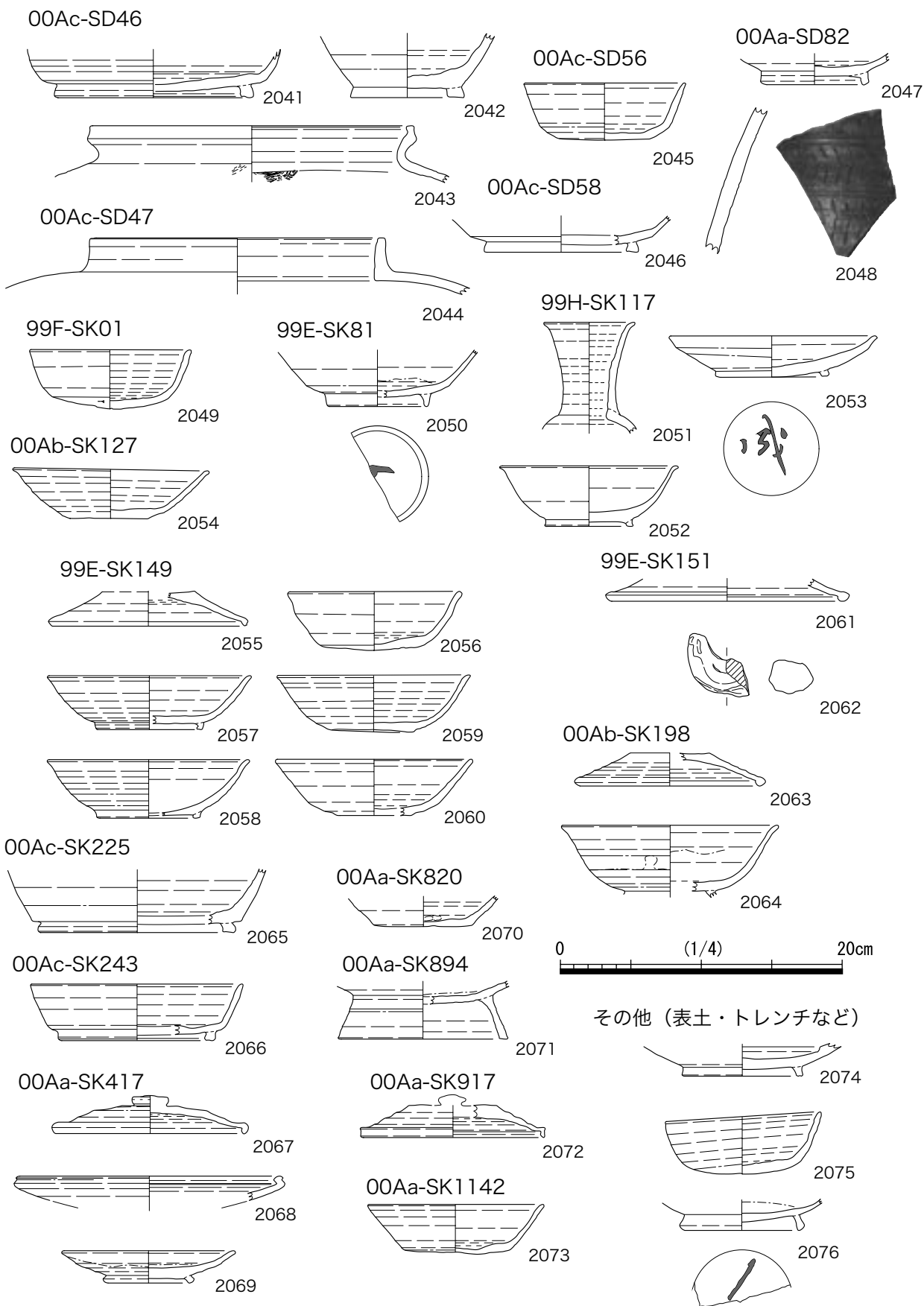

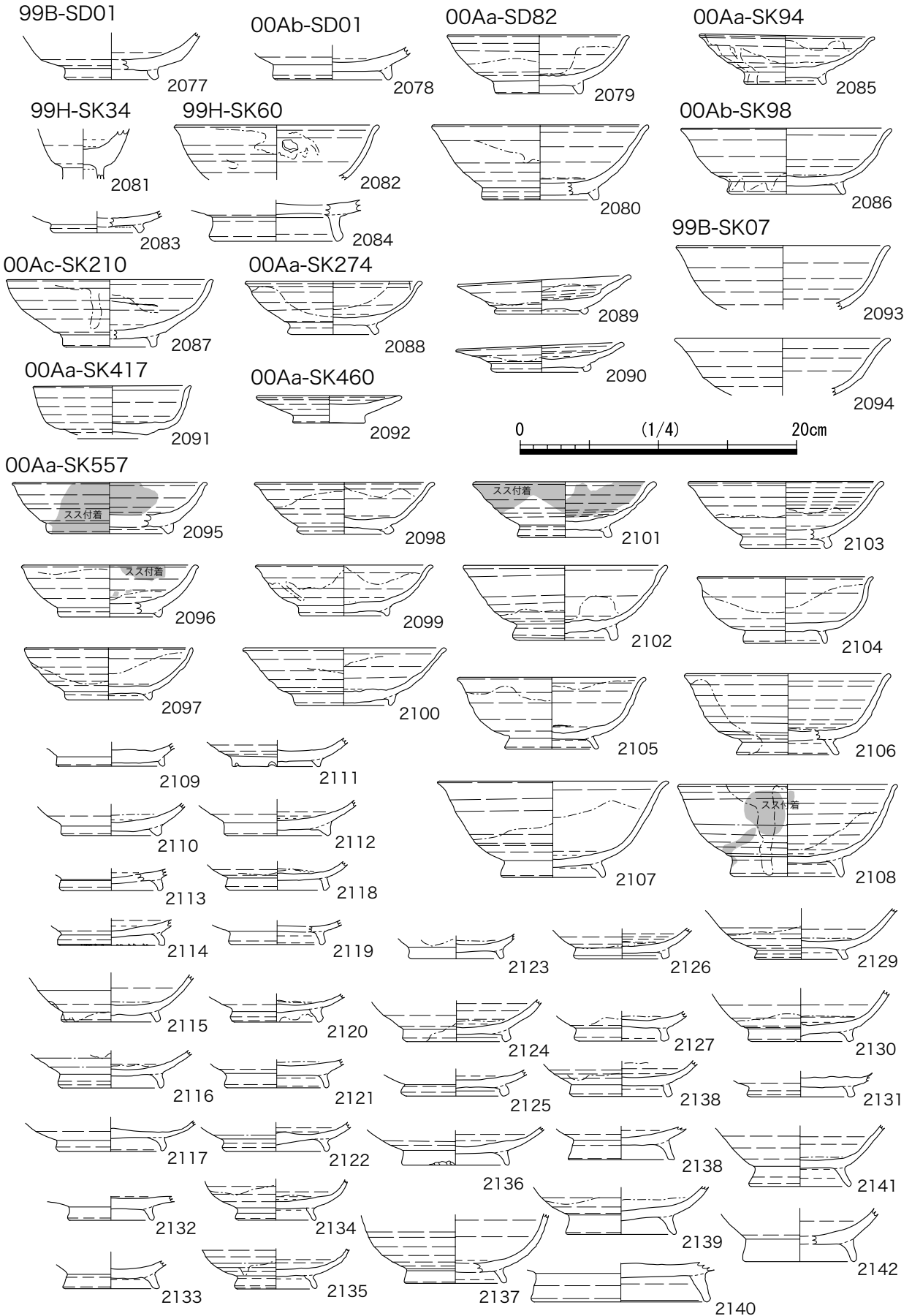

00Aa-SK557

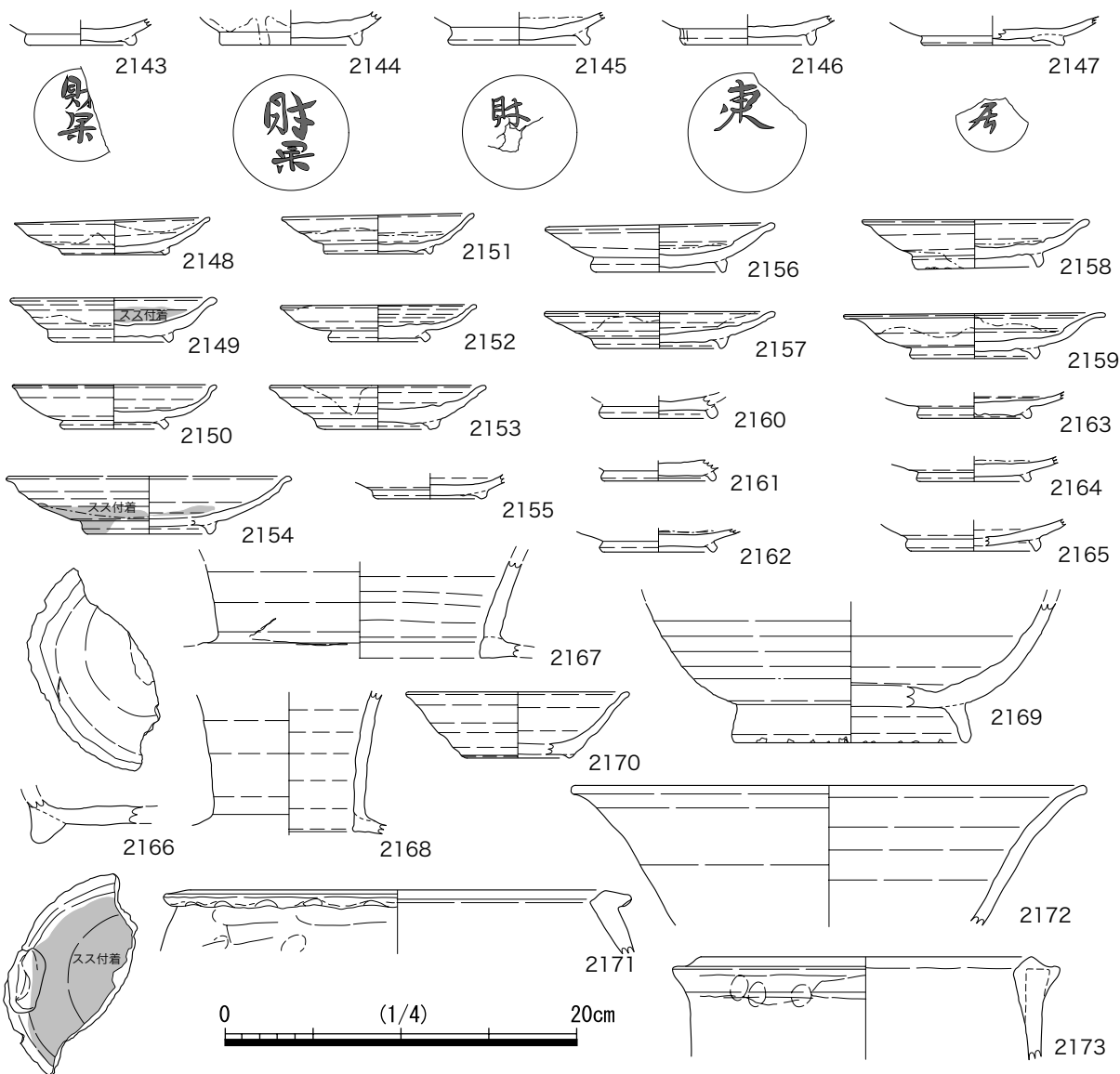

00Aa-SK583

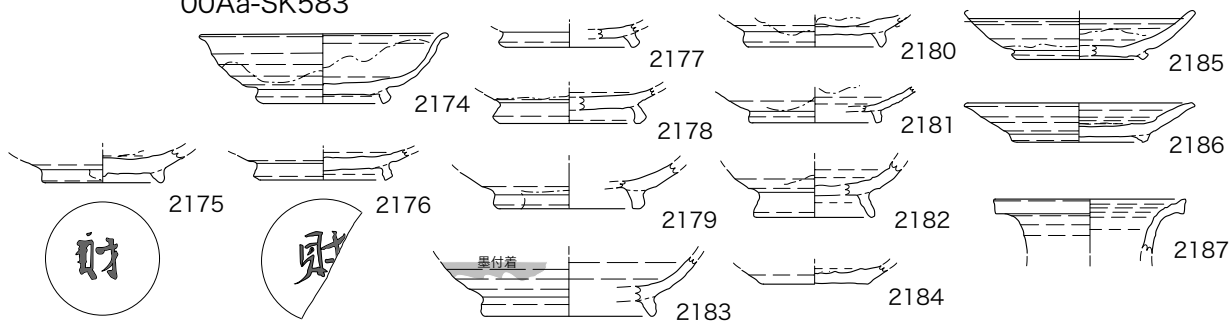

00Aa-SK974

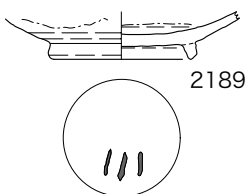

00Aa-SK933

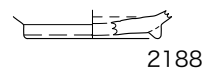

00Aa-SK1148

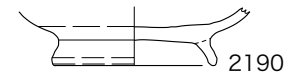

00Aa-SK1157

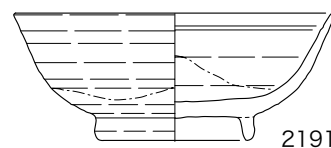

99E-SK01

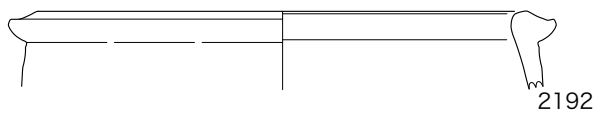

包含層



中世

99FSD08

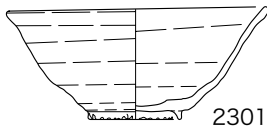

2301

99ISK02

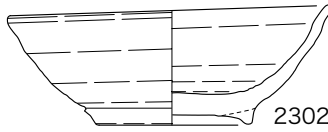

2302

99BSK29

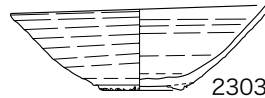

2303

99HSK70

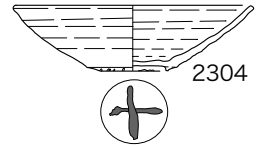

2304

99CbSK103

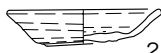

2305

99HSK121

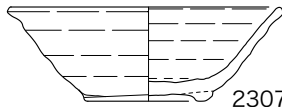

2307

99ESK135

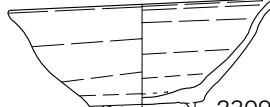

2309

00AaSK145

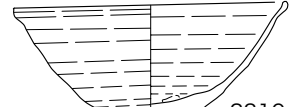

2310

99HSK110



2306

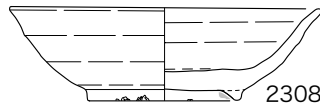

2308



99HSK263



2311

00AaSK450

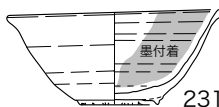

2312

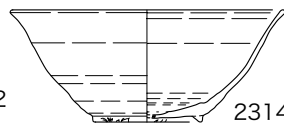

2314

00AaSK451



2316

00AaSK654

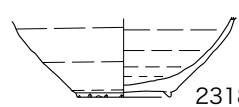

2318

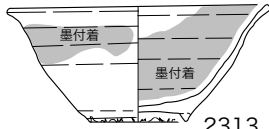

2313

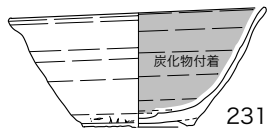

2315

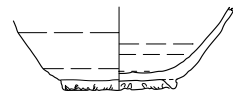

2317



00AaSK732

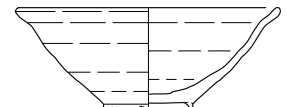

2319



00AaSK873

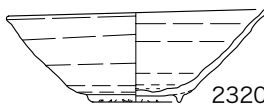

2320



99CbP105

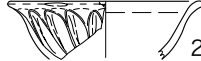

2321

その他 (表土・包含層など)

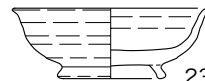

2323



2324

99CbP181

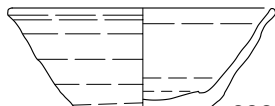

2322

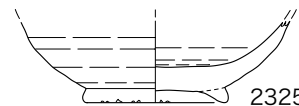

2325

土錘

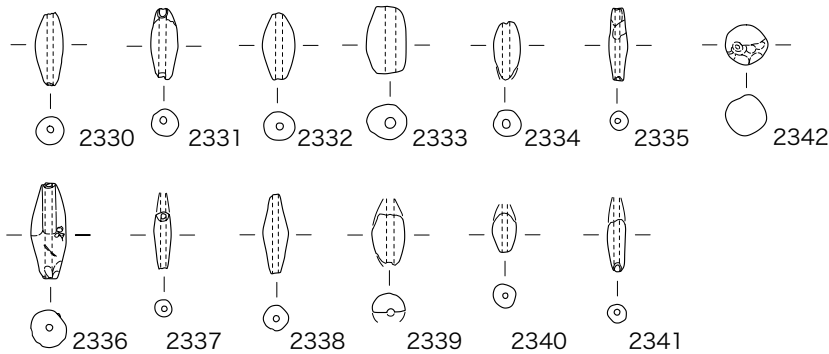

陶丸

近世 (縮尺1/2)

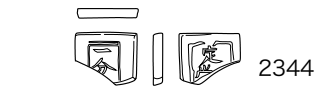

(実物大写真)

0 (1/4) 20cm

S=2/3

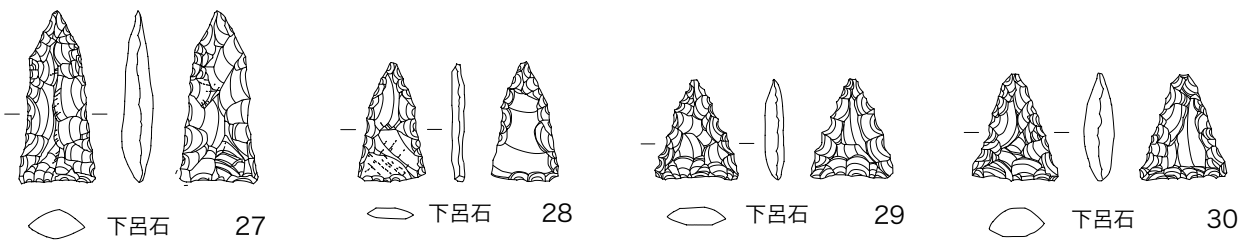
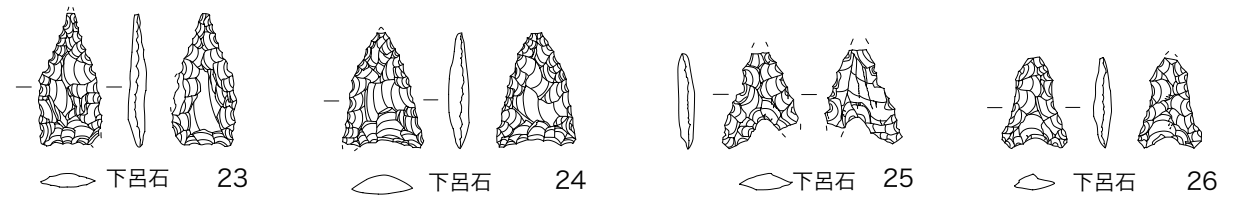
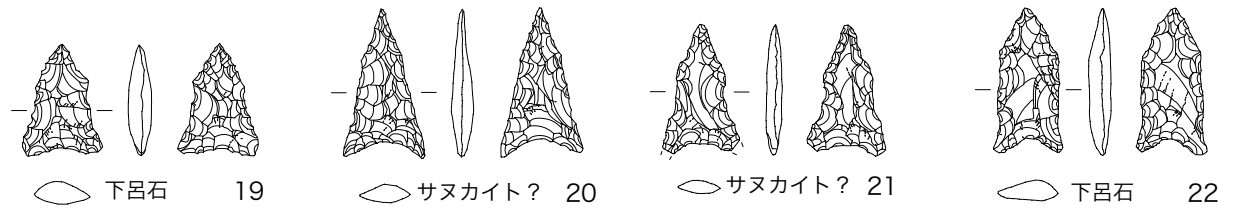
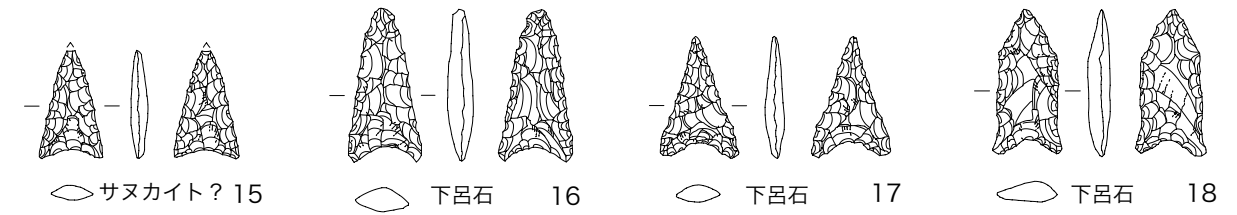
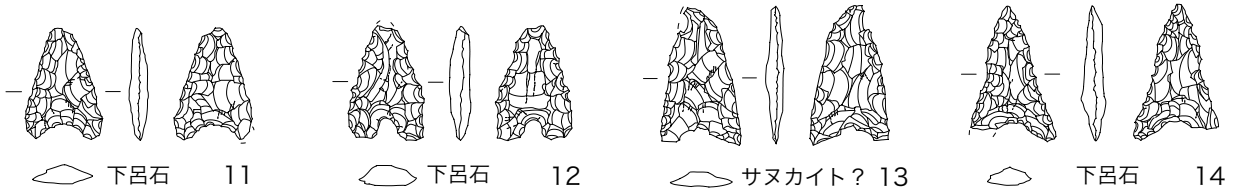
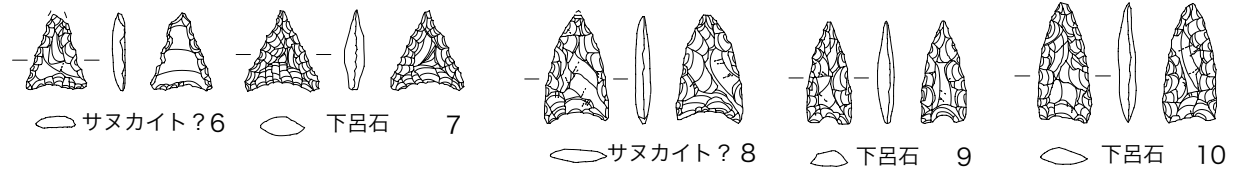
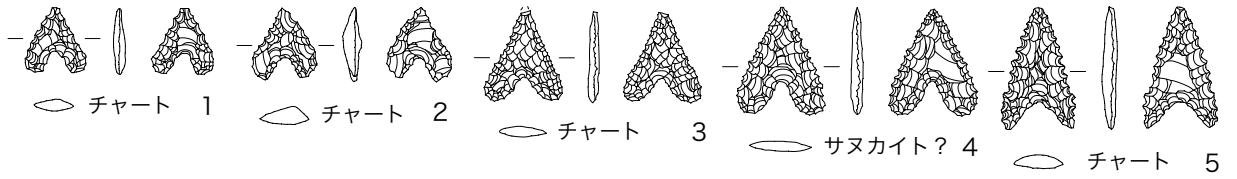

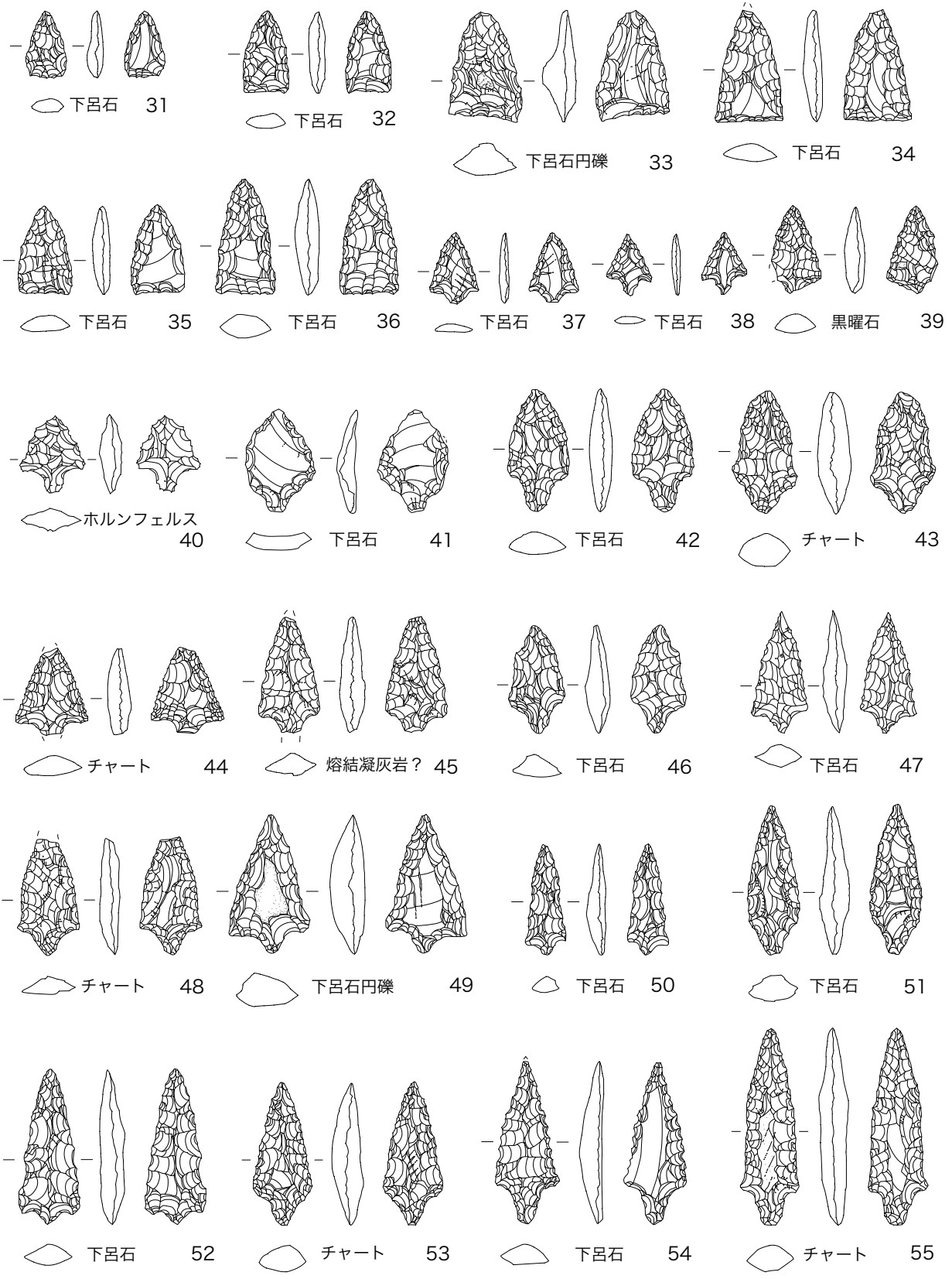

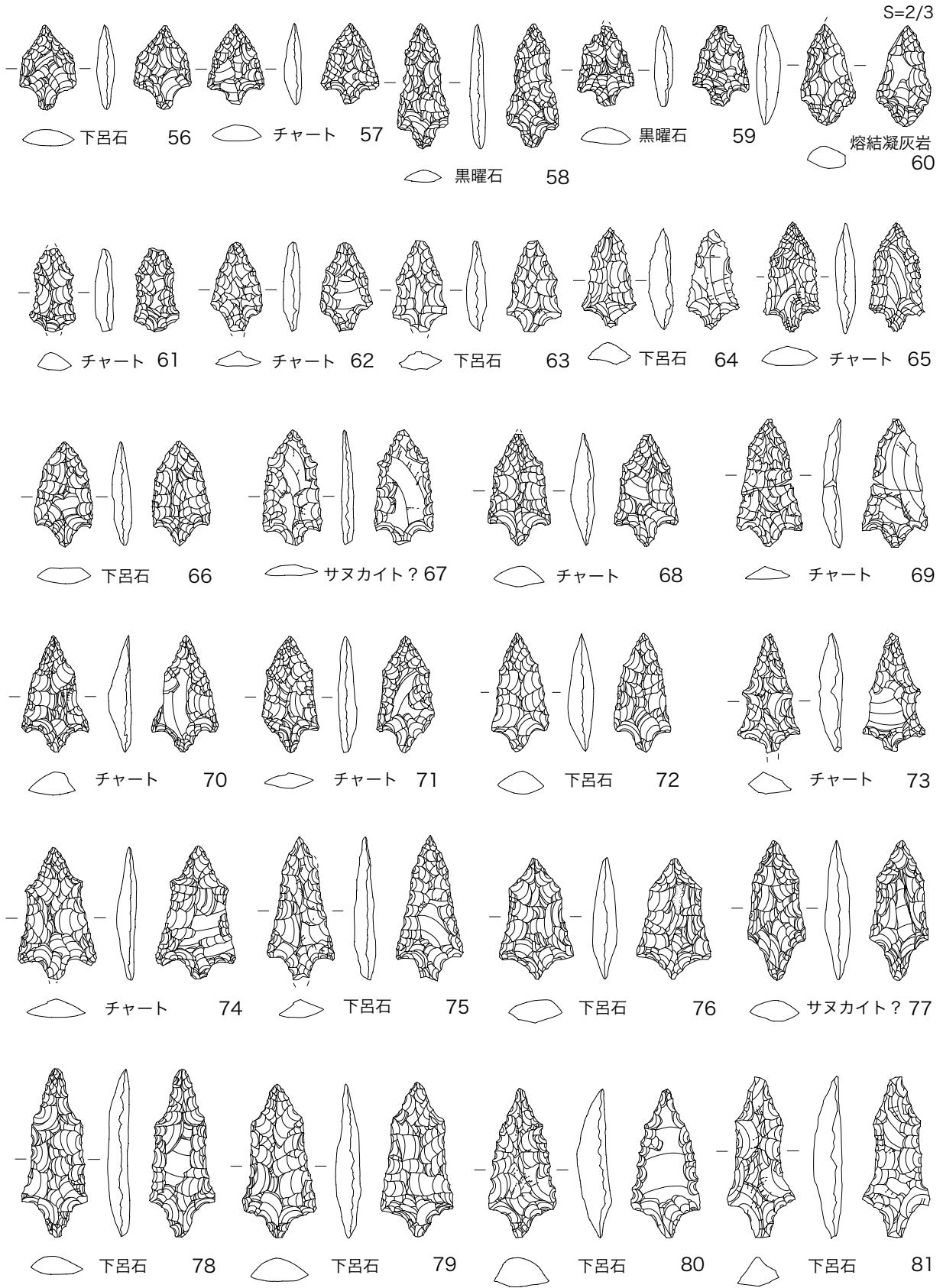

S=2/3



チャート 82



チャート 83

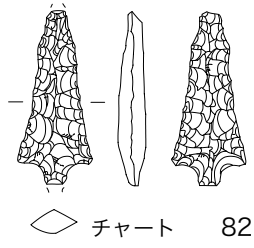

下呂石 84

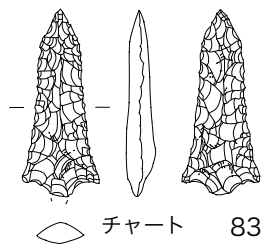
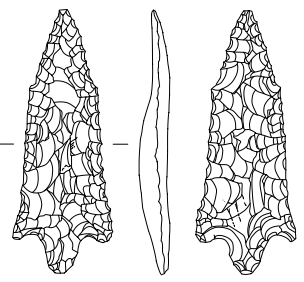
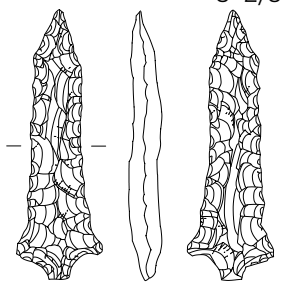

下呂石 85

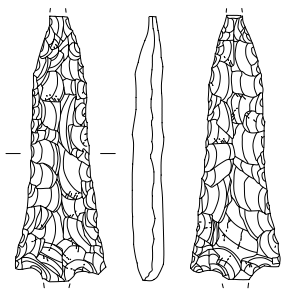

下呂石 86

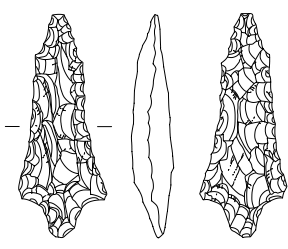

下呂石 87

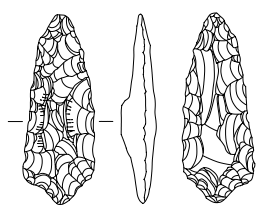

サヌカイト? 88



チャート 89



下呂石 90

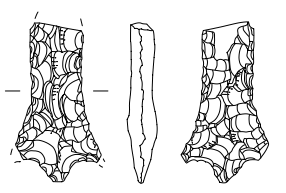
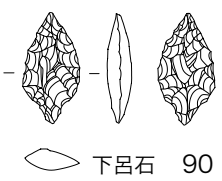
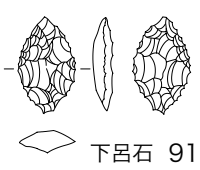

下呂石 91

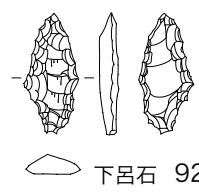

下呂石 92

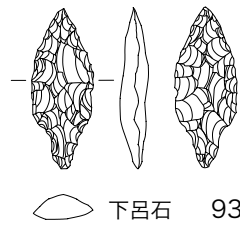

下呂石 93

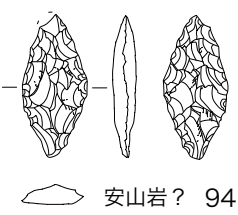

安山岩? 94

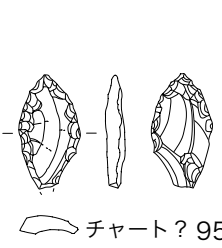

チャート? 95

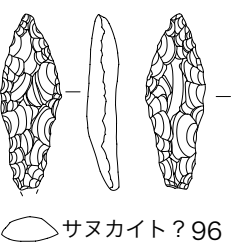

サヌカイト? 96

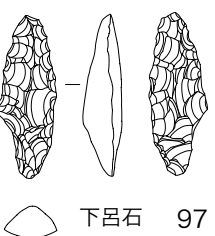

下呂石 97

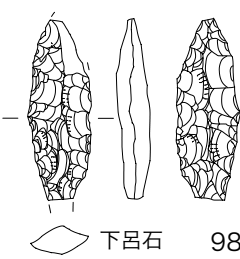

下呂石 98

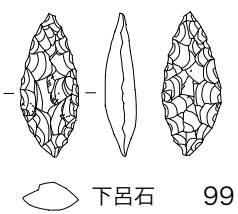

下呂石 99

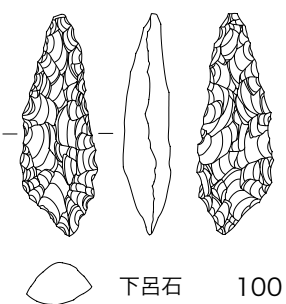

下呂石 100

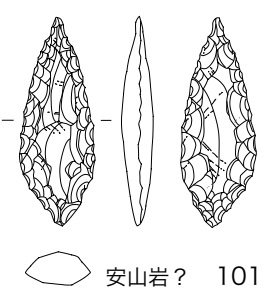

安山岩? 101

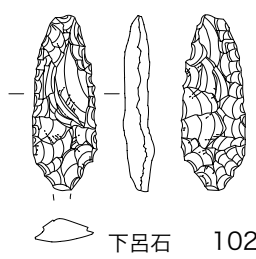

下呂石 102

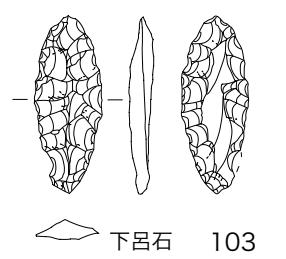

下呂石 103

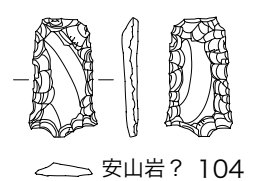

安山岩? 104

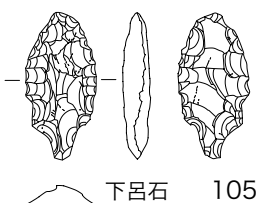

下呂石 105

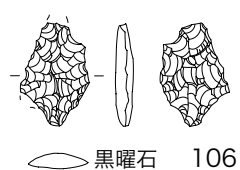

黒曜石 106

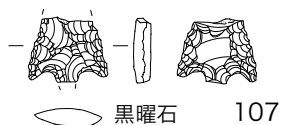

黒曜石 107

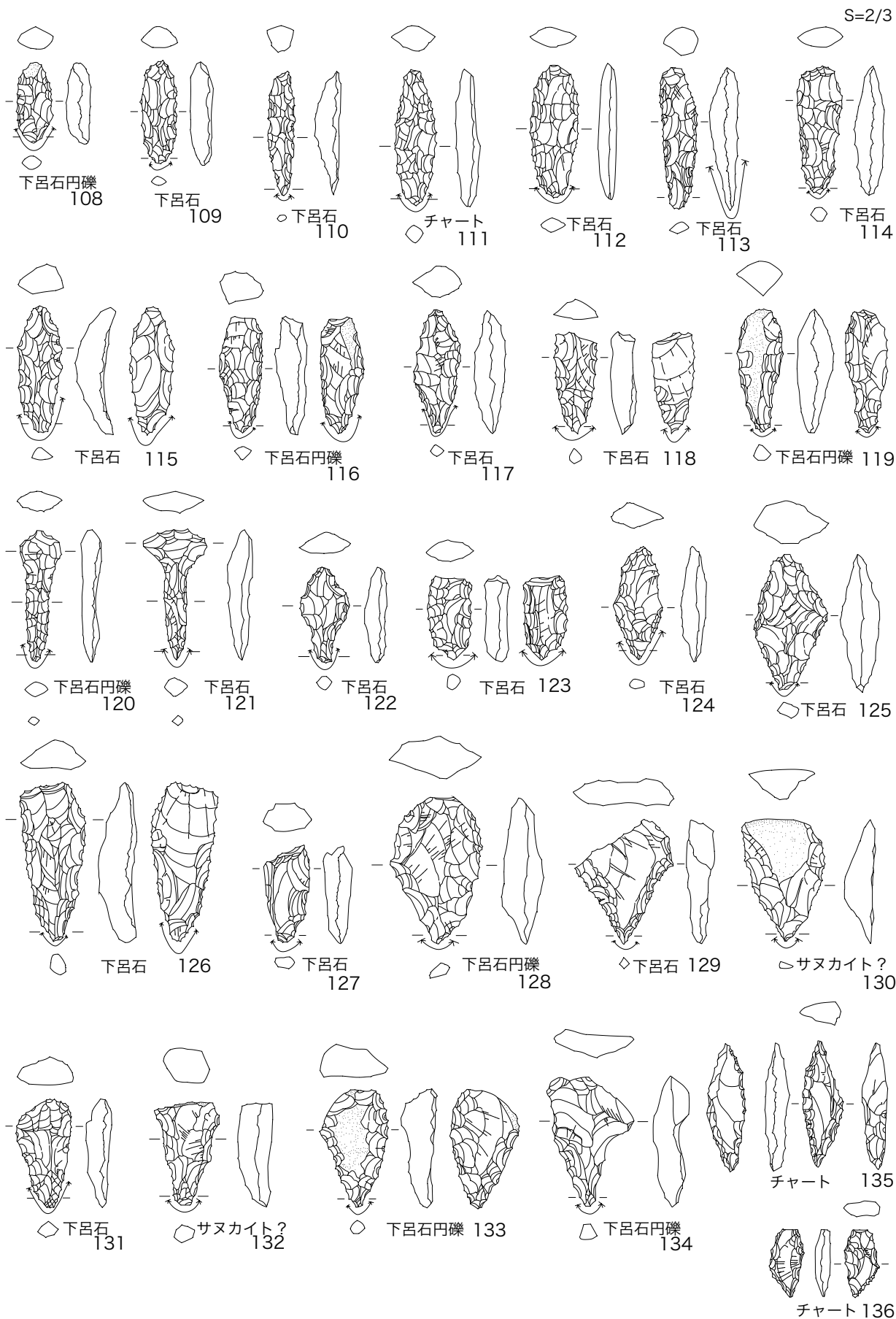

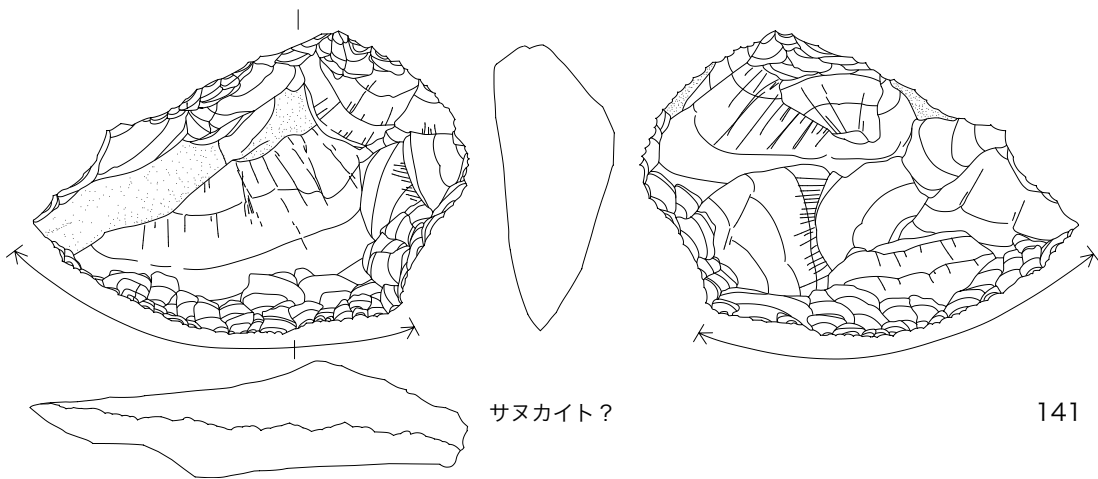
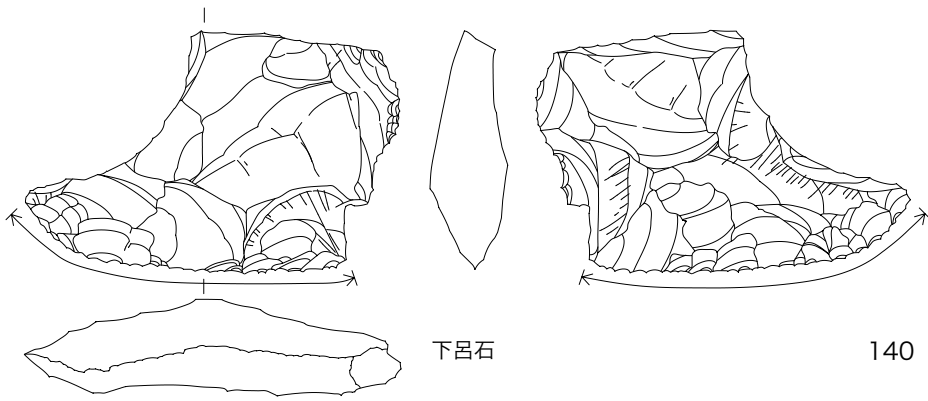
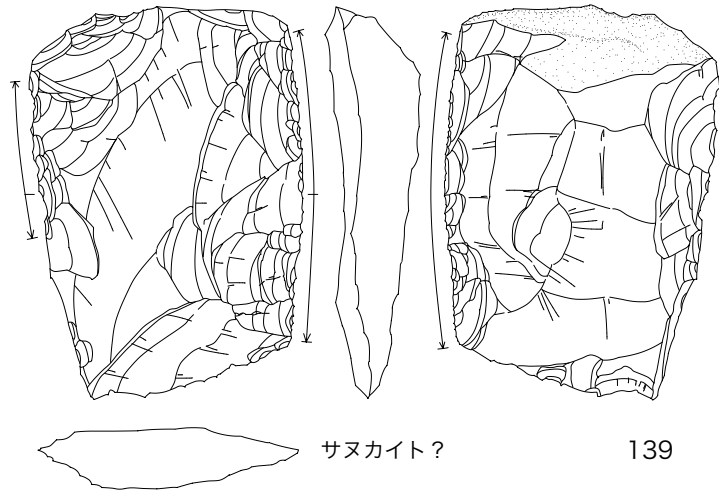
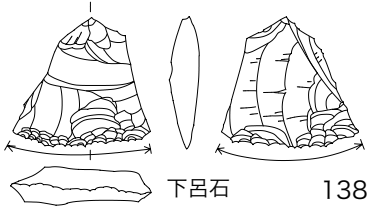
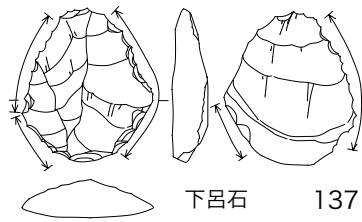

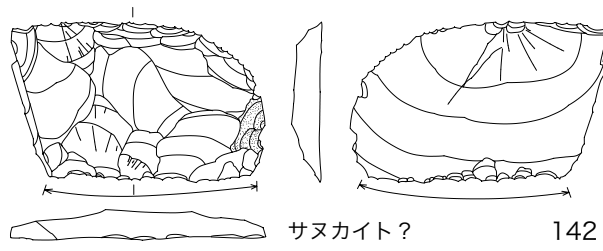

サヌカイト? 142

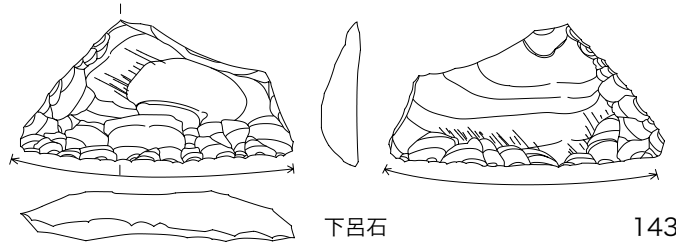

下呂石 143

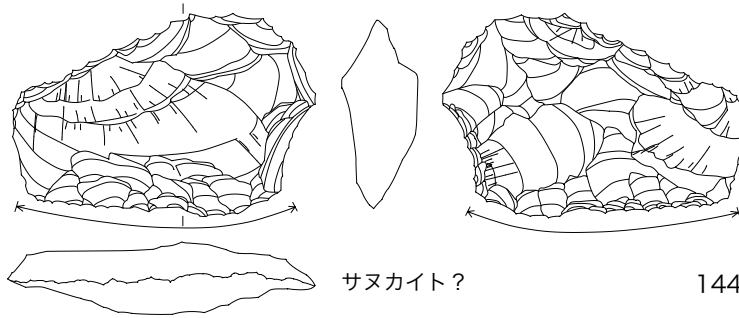

サヌカイト? 144

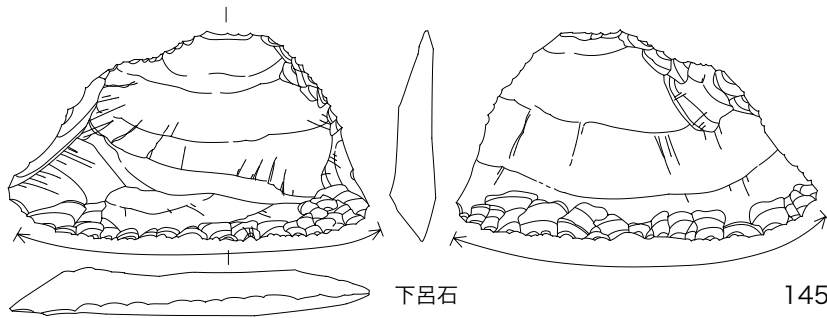

下呂石 145

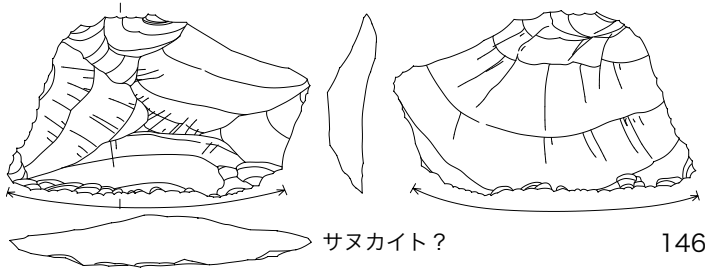

サヌカイト? 146

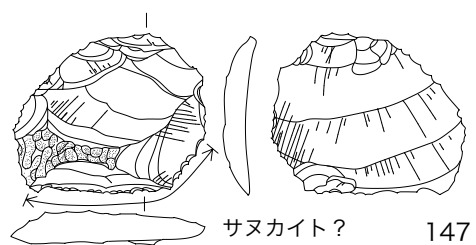

サヌカイト? 147

S=2/3

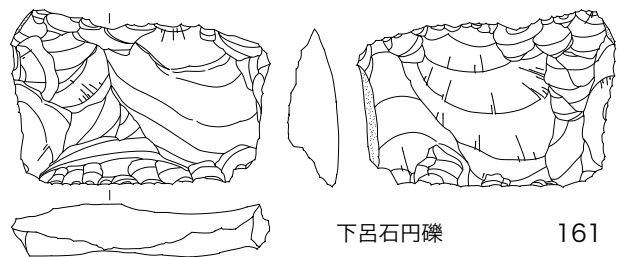
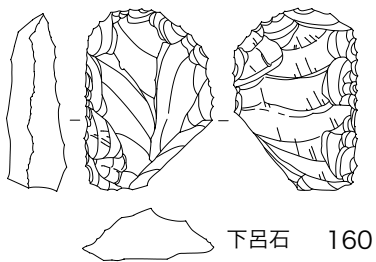
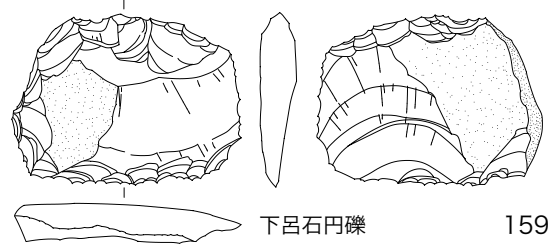
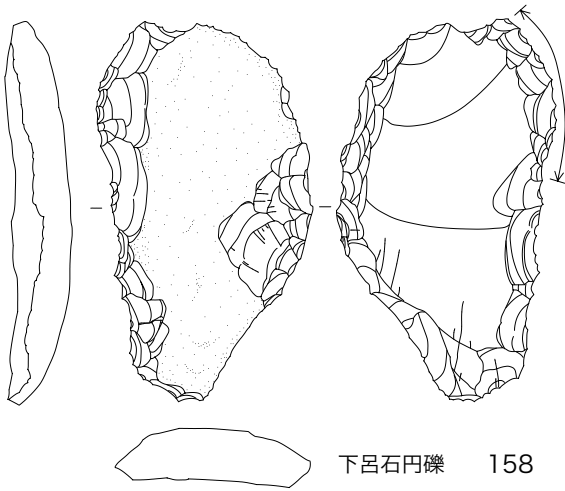
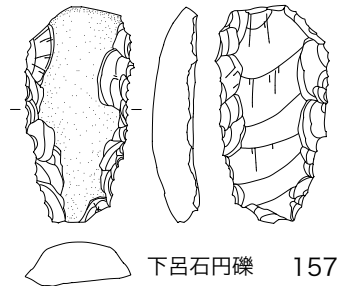
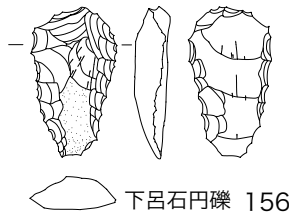
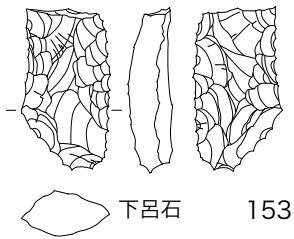
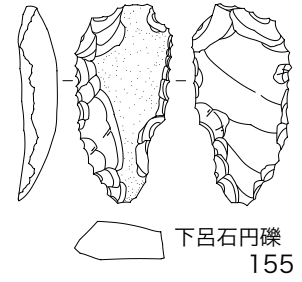
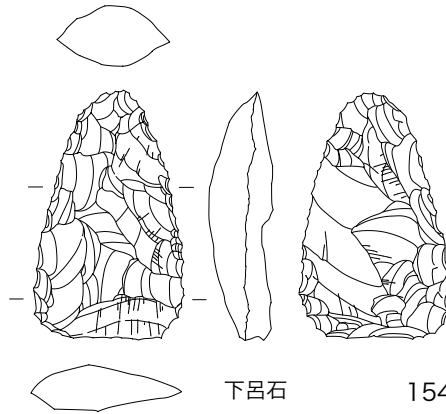
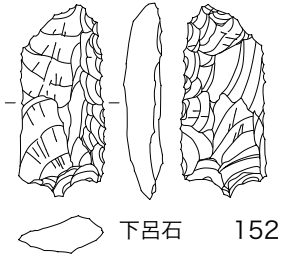
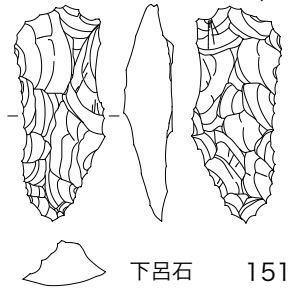
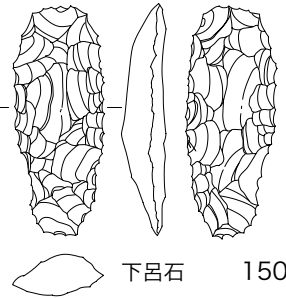
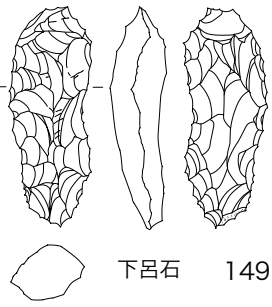
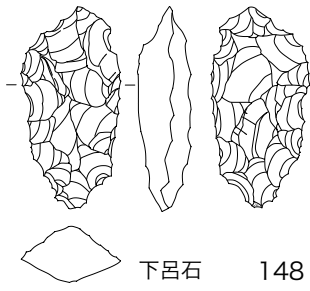

S=2/3

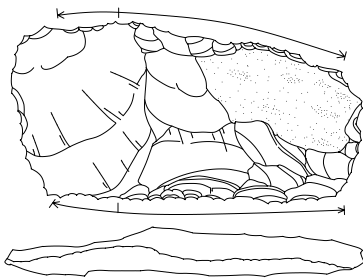

ホルンフェルス

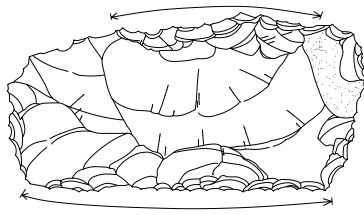

162

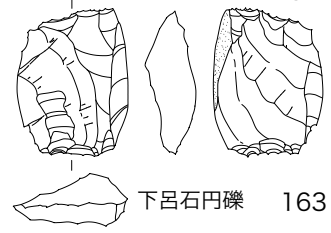

下呂石円礫 163

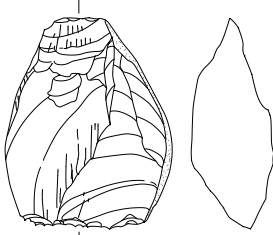

下呂石円礫

164

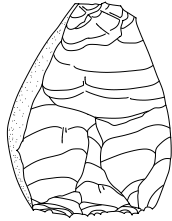

下呂石円礫 165

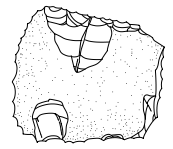
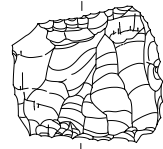
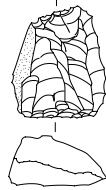

下呂石円礫 166

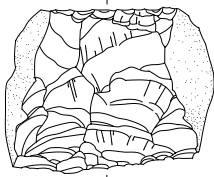

下呂石円礫

167

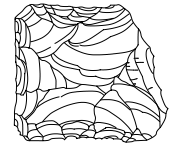
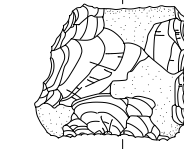
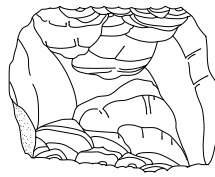

下呂石円礫 168

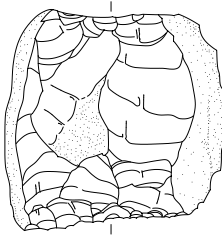

チャート

170

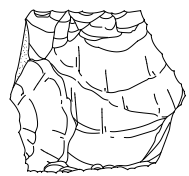
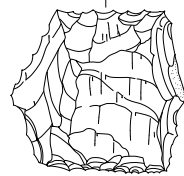
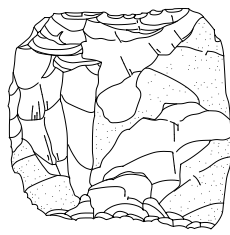

下呂石円礫 169

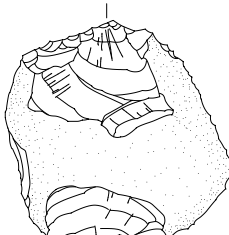

下呂石円礫

172

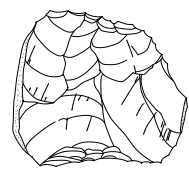
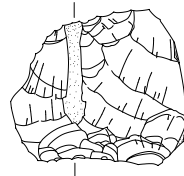
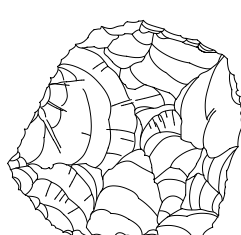

下呂石円礫 171

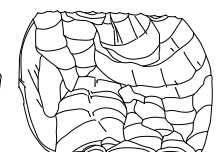
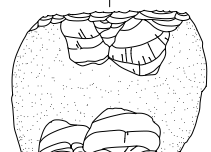

下呂石円礫

173

S=2/3

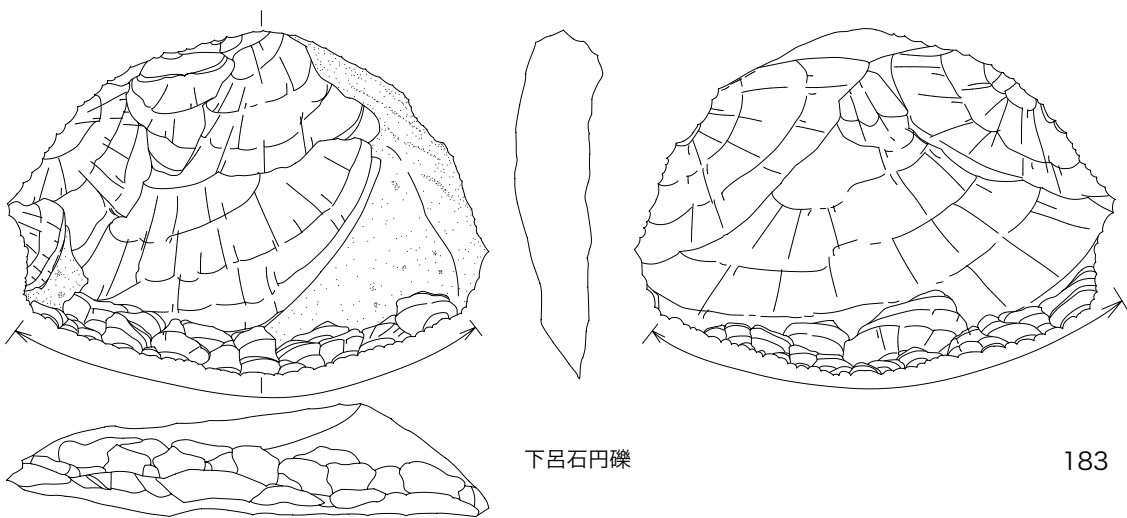
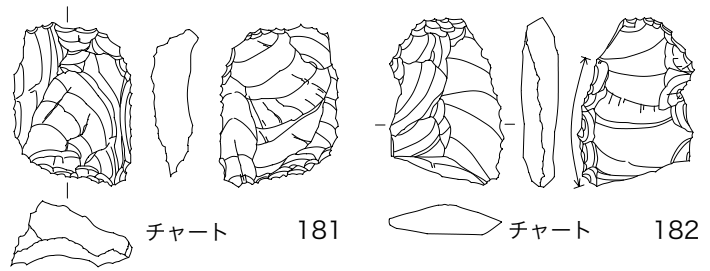
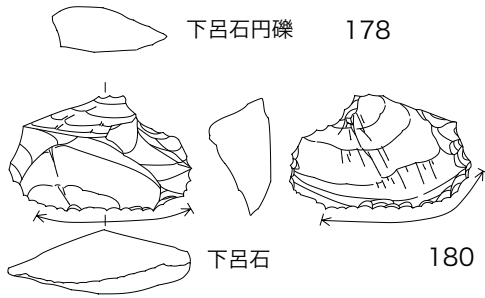
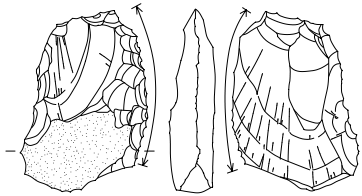
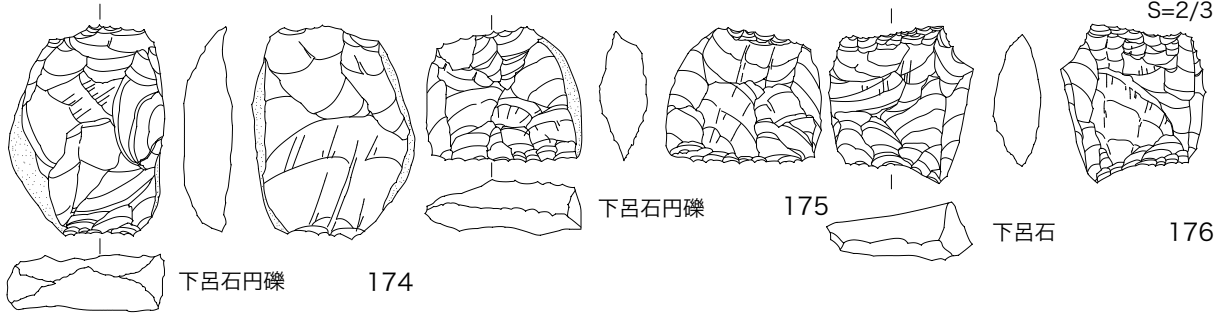

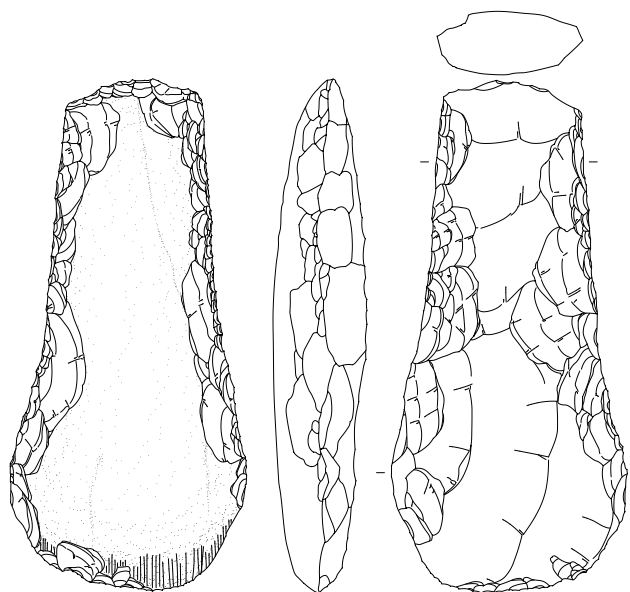

砂岩 184

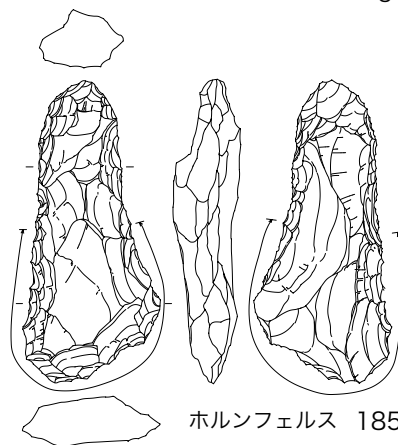

ホルンフェルス 185

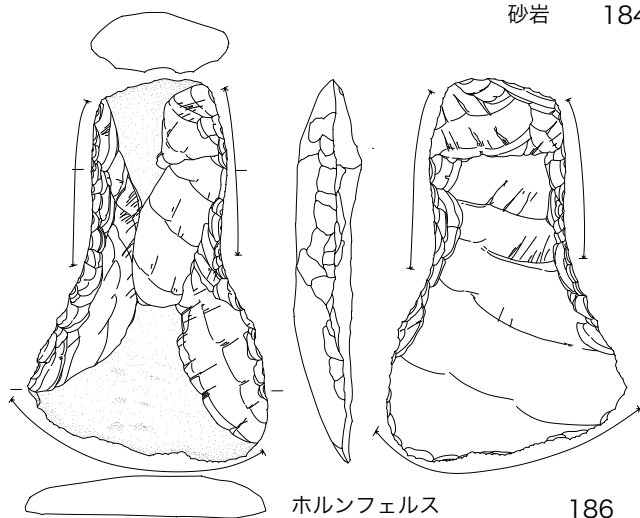

ホルンフェルス 186

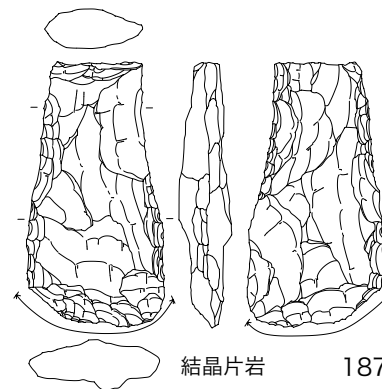

結晶片岩 187

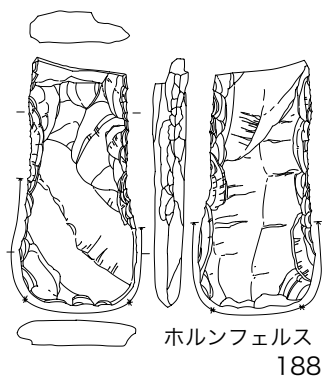

ホルンフェルス 188

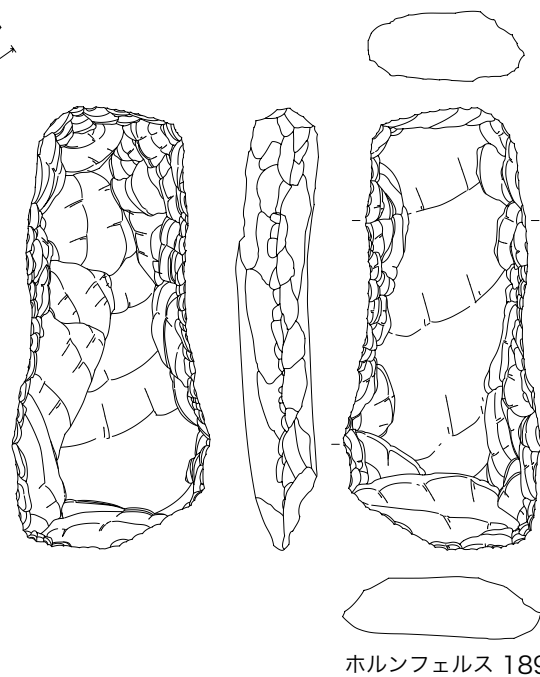

ホルンフェルス 189

S=1/3

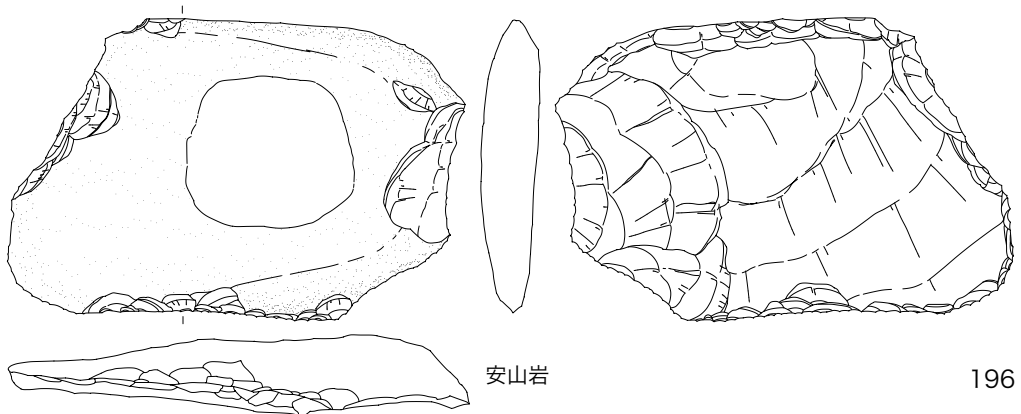
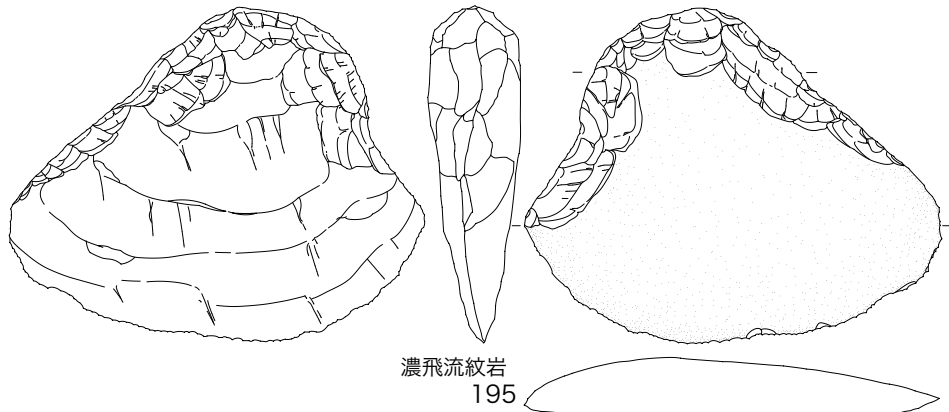
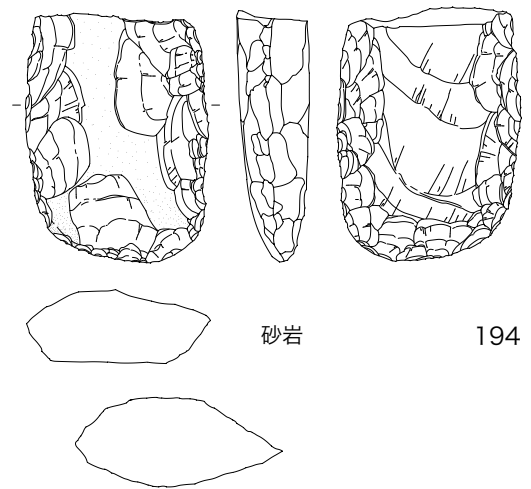
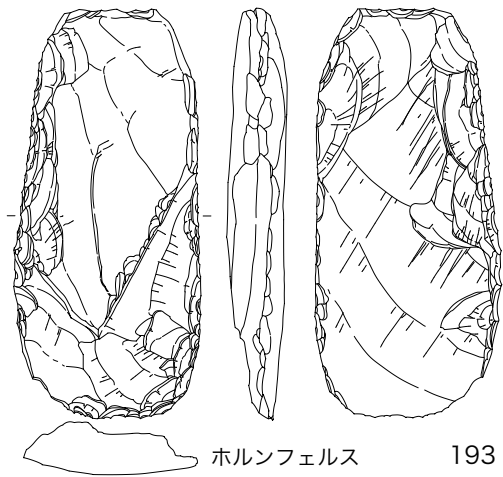
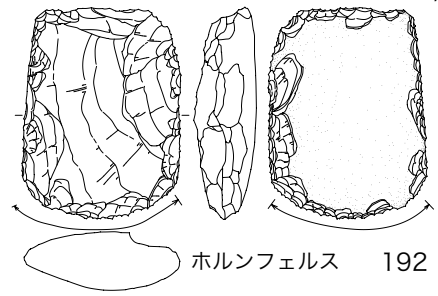
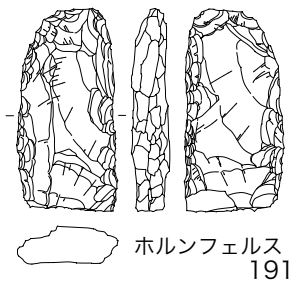
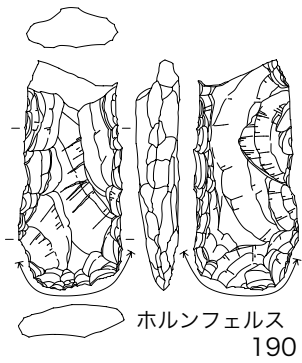

S=1/3

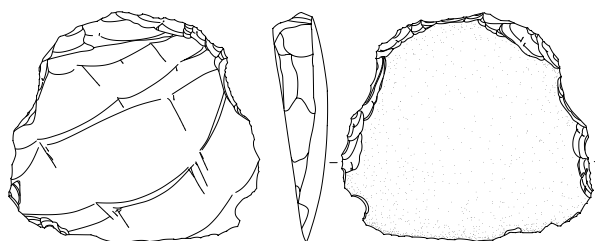

泥岩 197

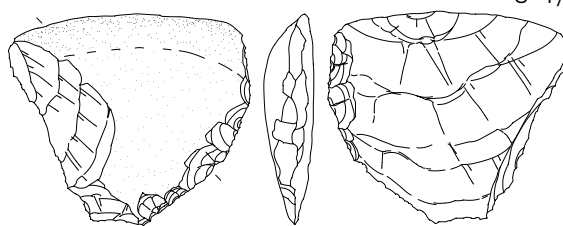

砂岩

198

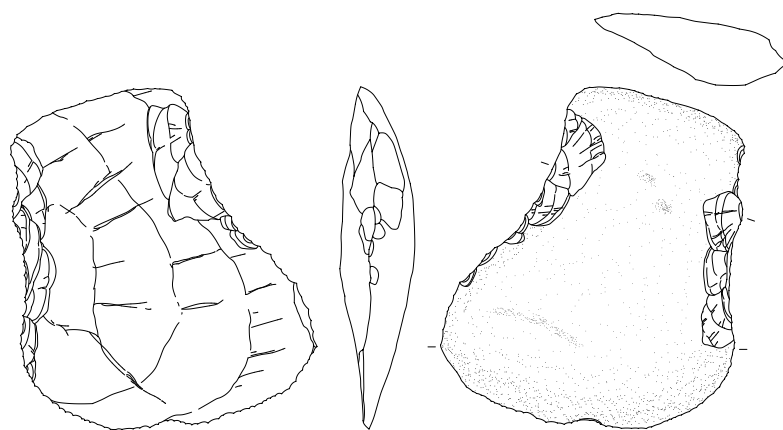

ホルンフェルス 199

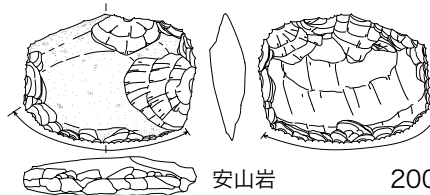

安山岩

200

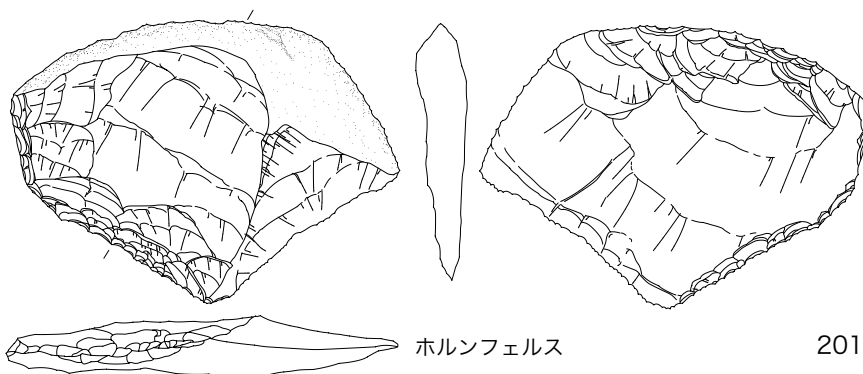

ホルンフェルス

201

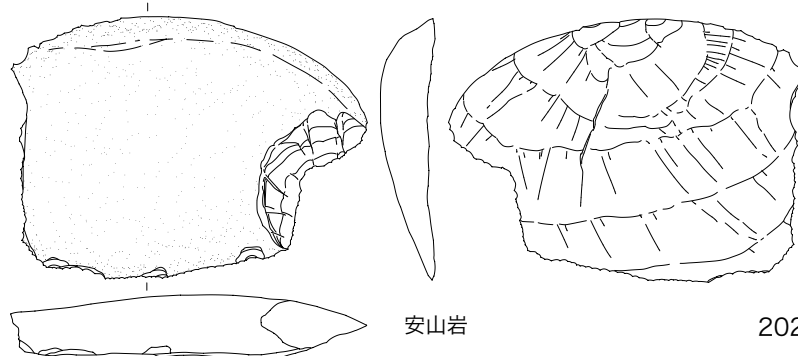

安山岩

202

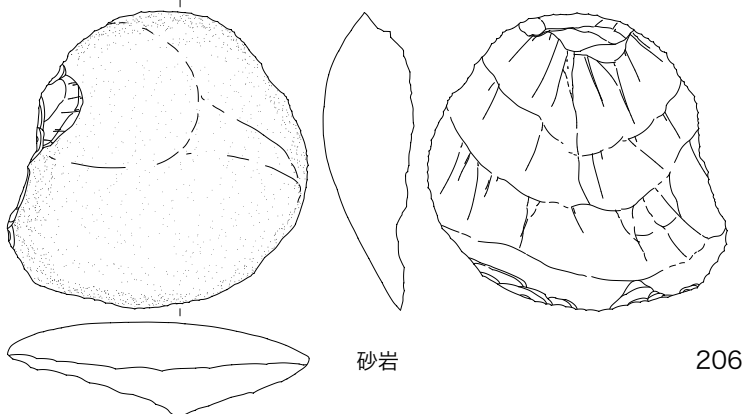
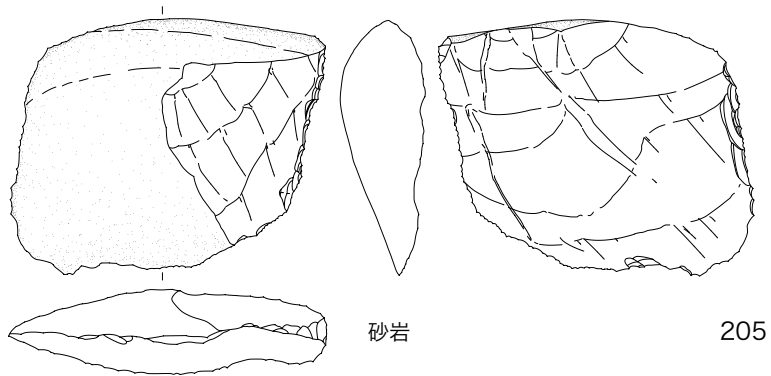
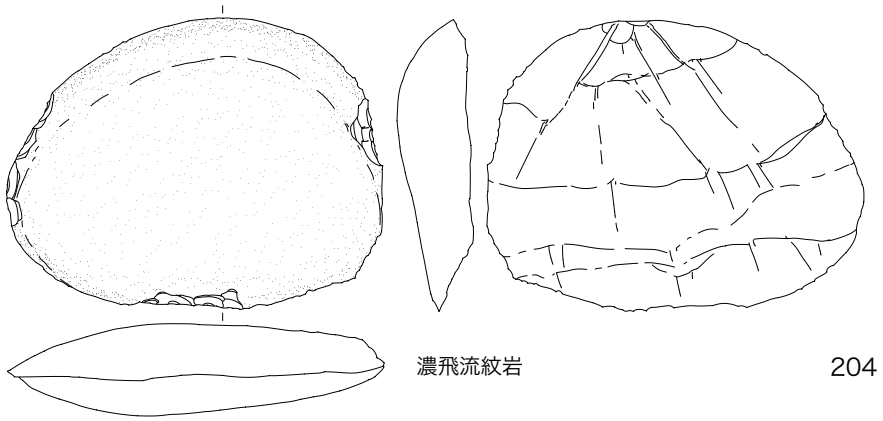
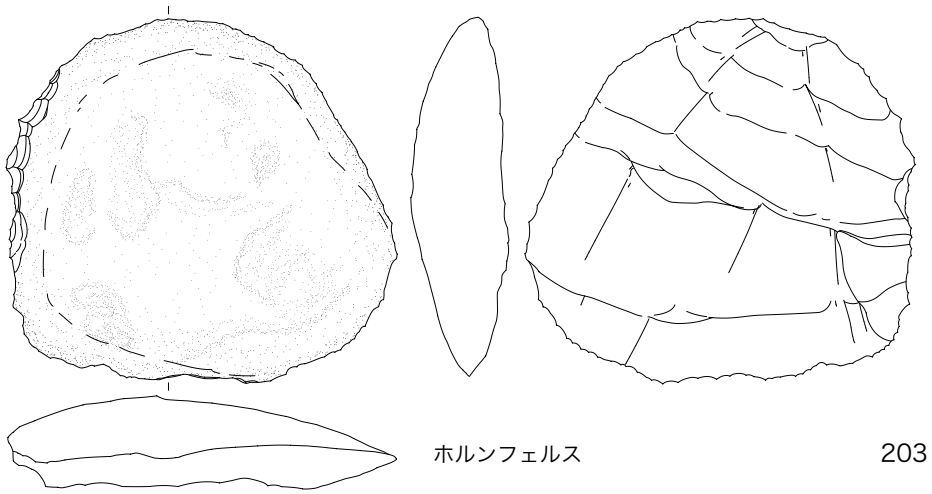

S=1/3

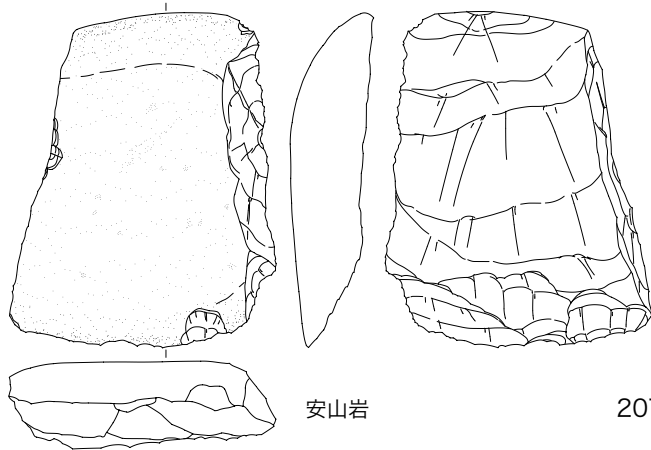

安山岩

207

濃飛流紋岩

208

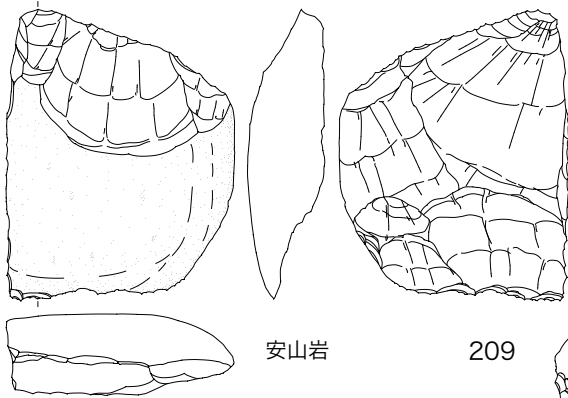

安山岩

209

砂岩

210

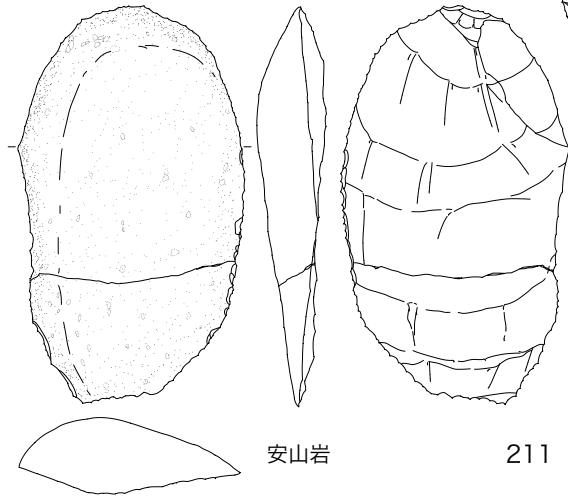

安山岩

211

砂岩

212

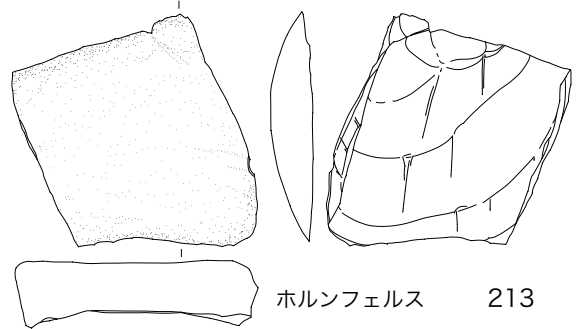

ホルンフェルス

213

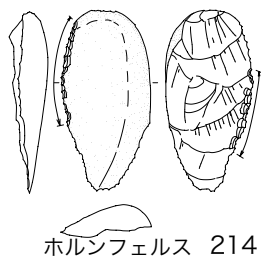

ホルンフェルス 214

ホルンフェルス 215

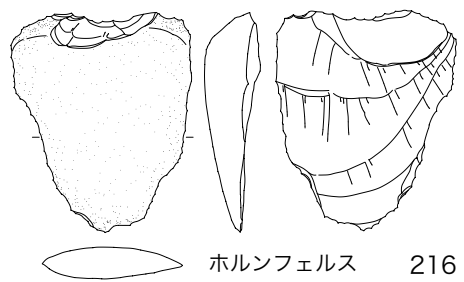

ホルンフェルス

216

S=1/3

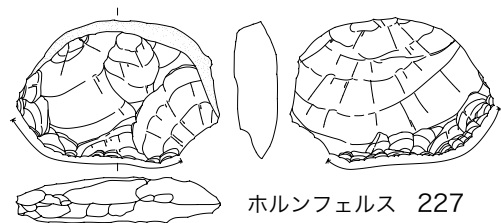
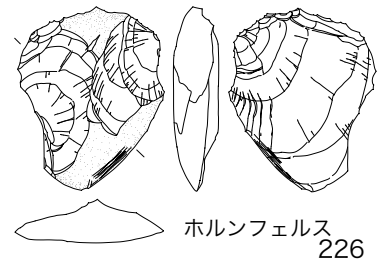
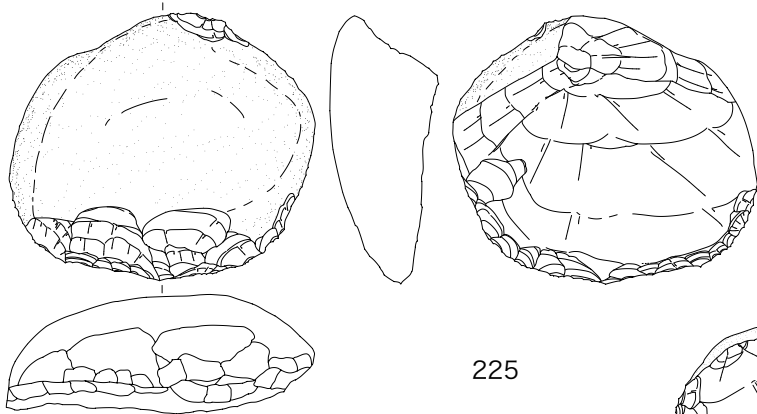
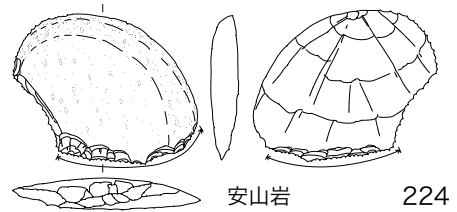
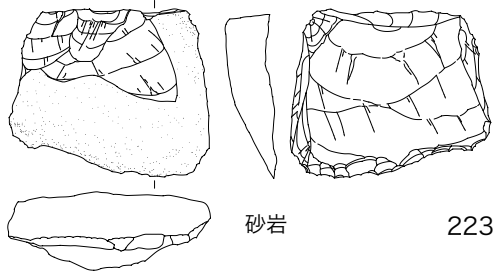
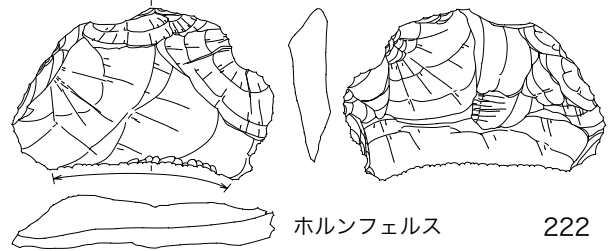
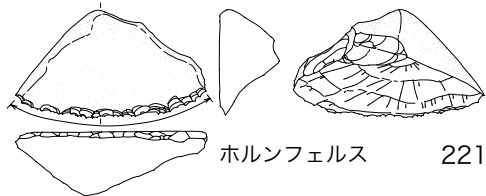
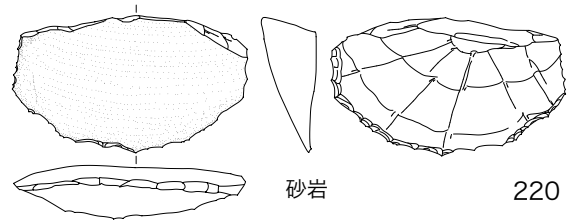
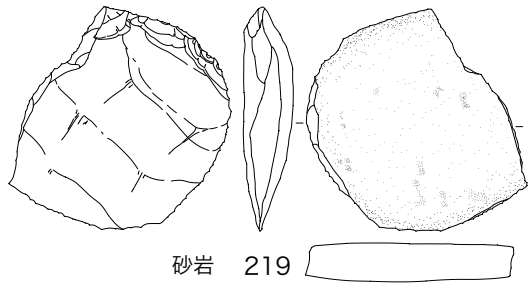
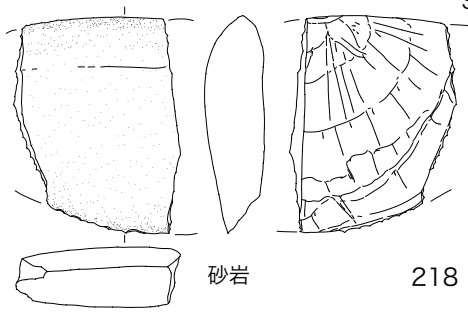
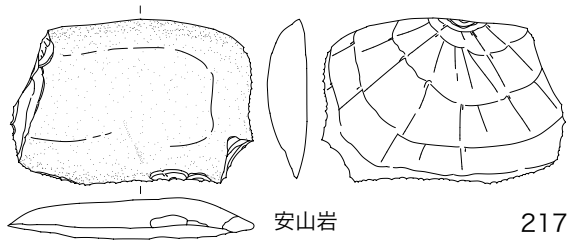

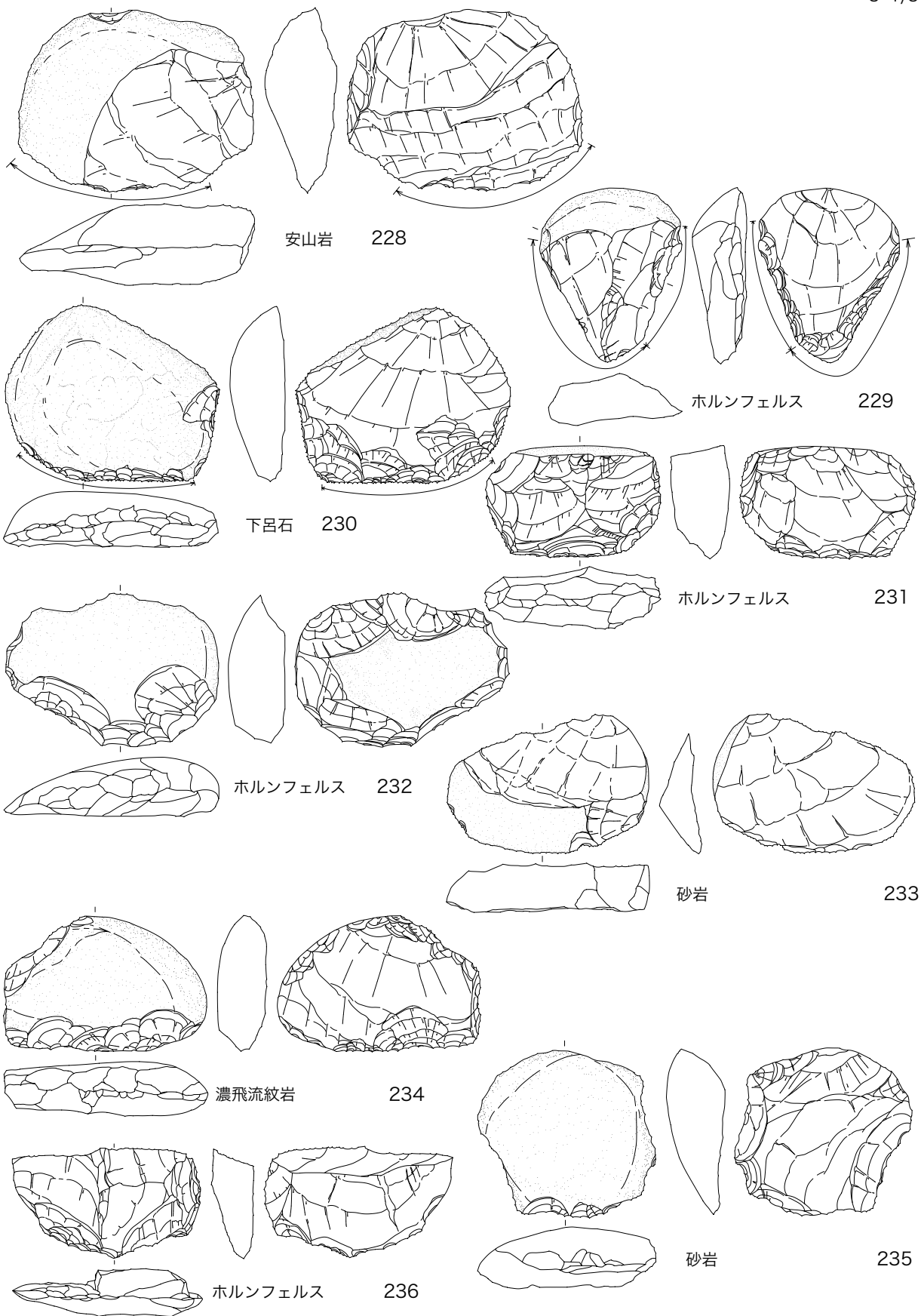

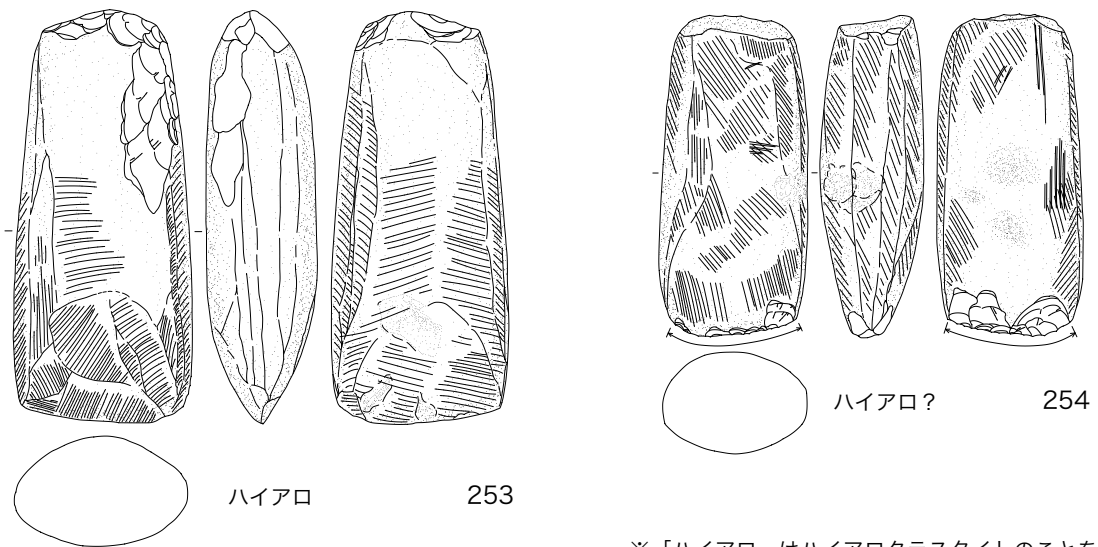
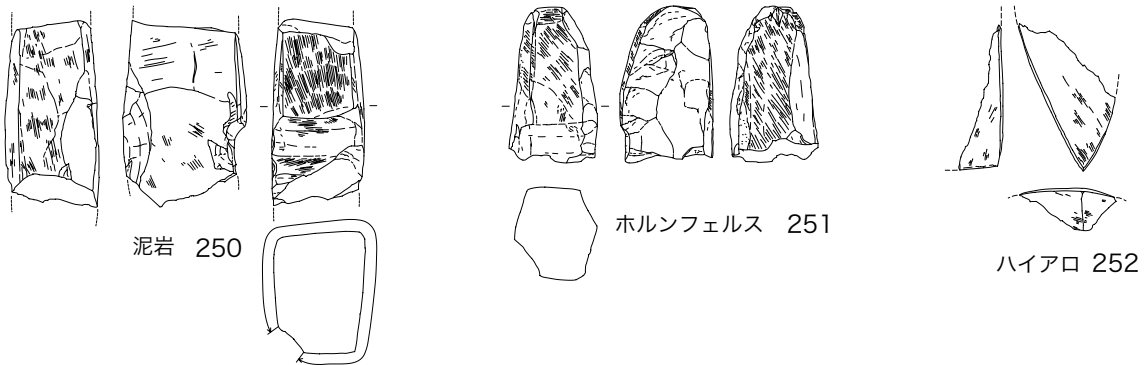
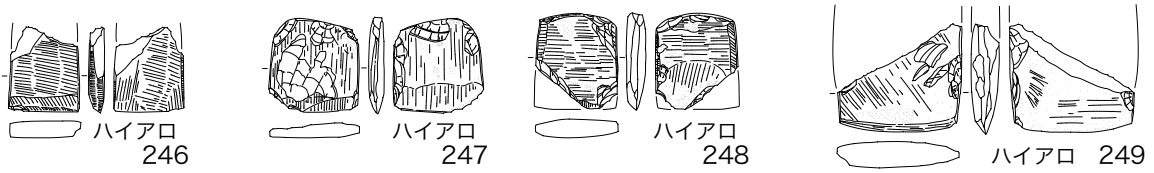
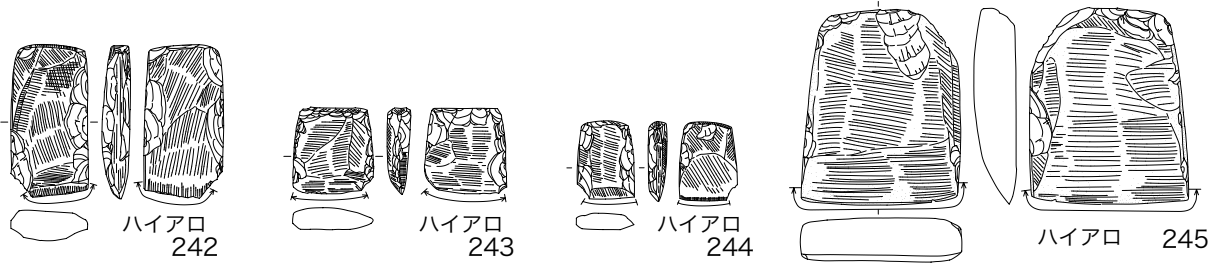
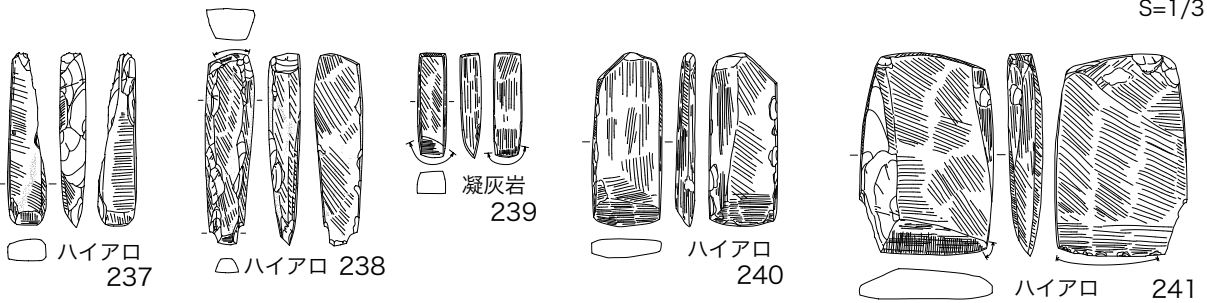

※「ハイアロ」はハイアロクラスタイトのことを示す

S=1/3

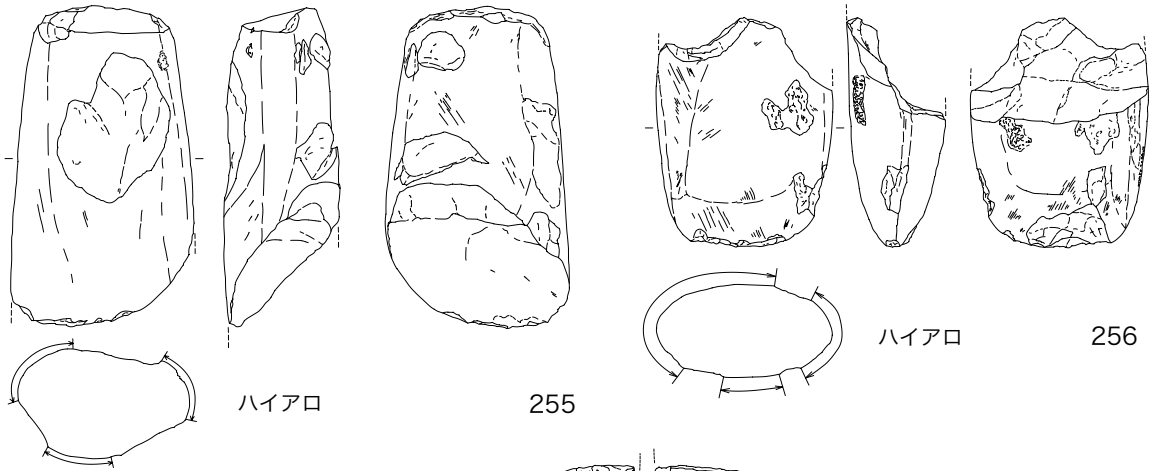

ハイアロ

255

ハイアロ

256

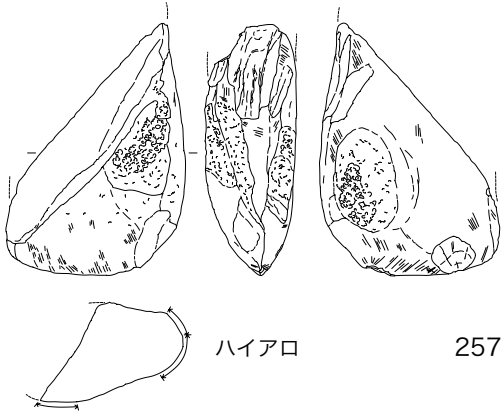

ハイアロ

257

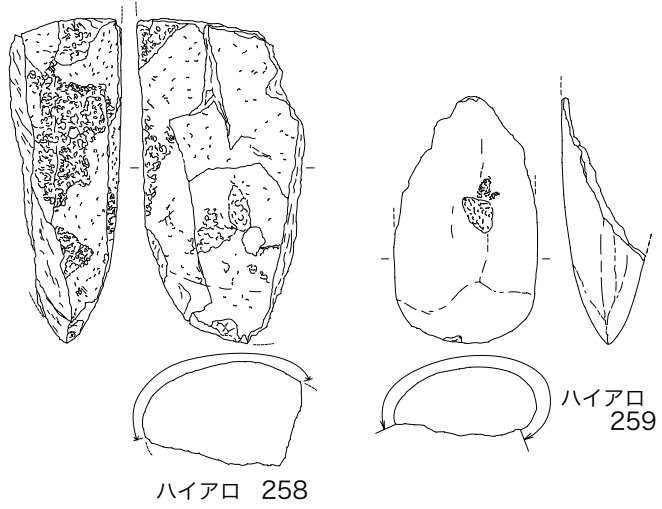

ハイアロ 258

ハイアロ
259

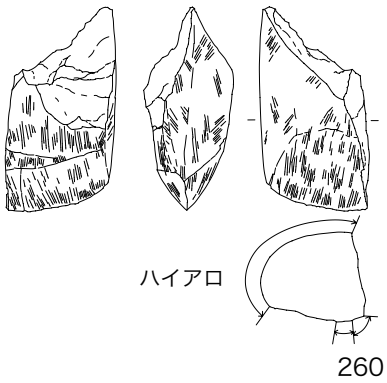

ハイアロ

260

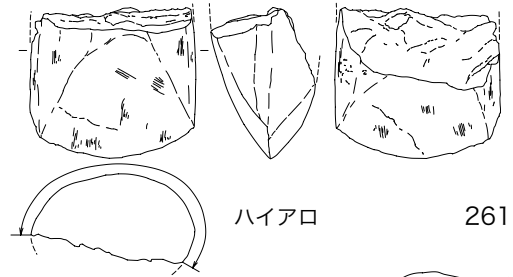

ハイアロ

261

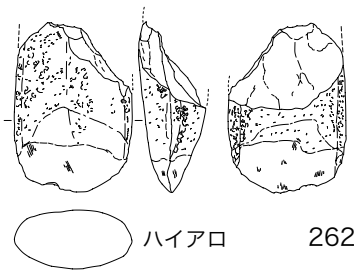

ハイアロ

262

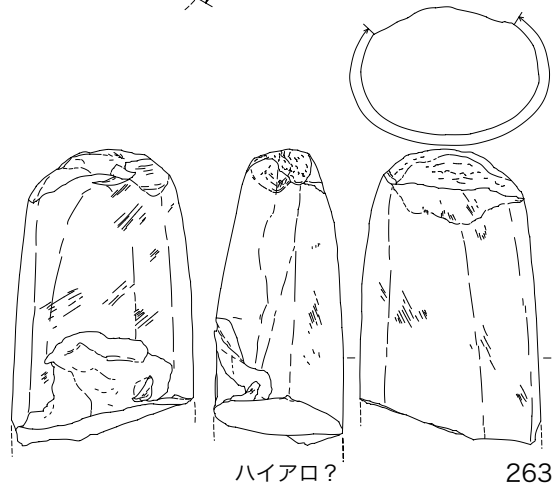

ハイアロ?

263

※「ハイアロ」はハイアロクラスタイトのことを示す

S=1/3

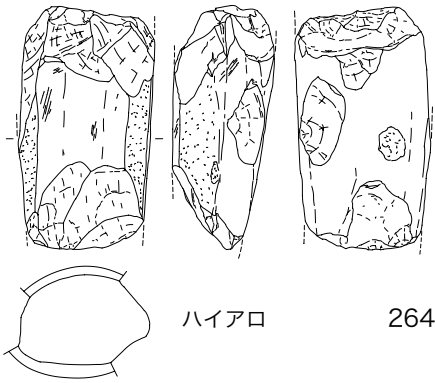

ハイアロ 264

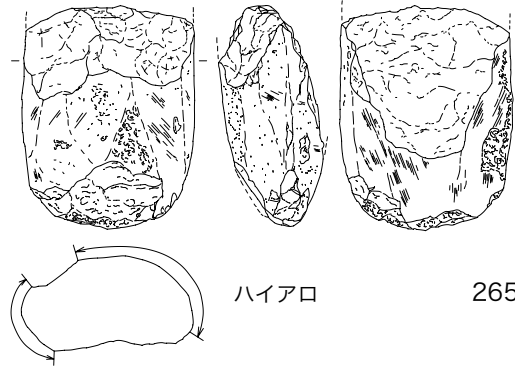

ハイアロ 265

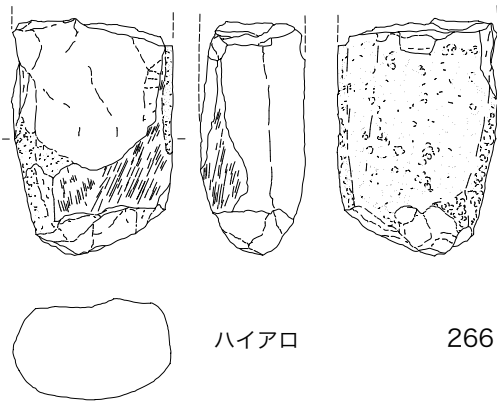

ハイアロ 266

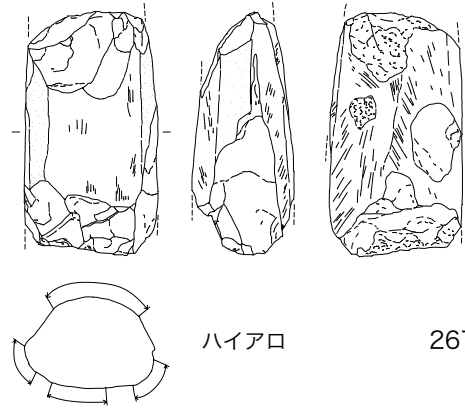

ハイアロ 267

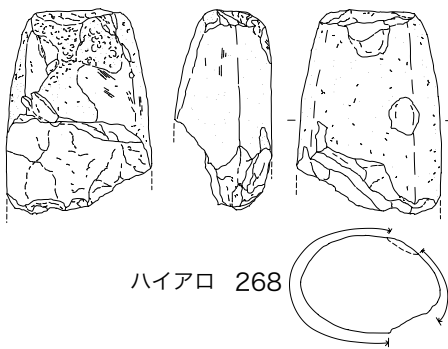

ハイアロ 268

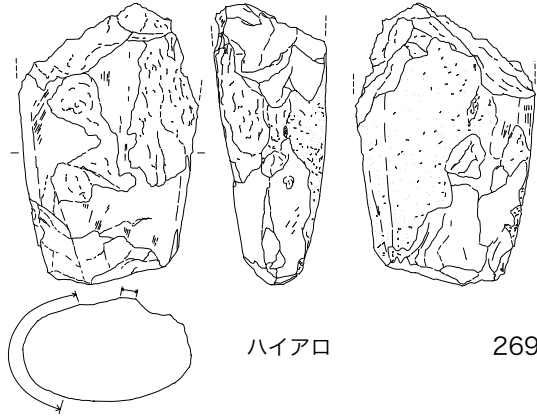

ハイアロ 269

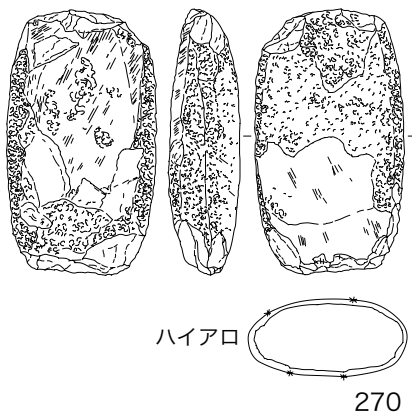

ハイアロ 270

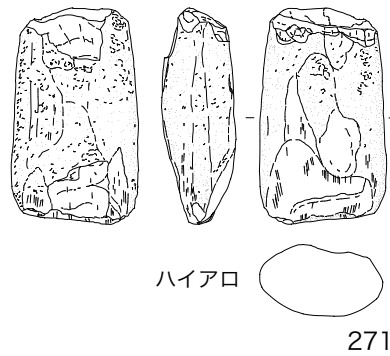

ハイアロ 271

※「ハイアロ」はハイアロクラスタイトのことを示す

S=1/3



ハイアロ 272

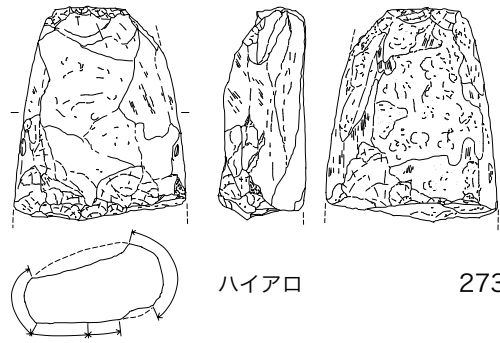

ハイアロ 273

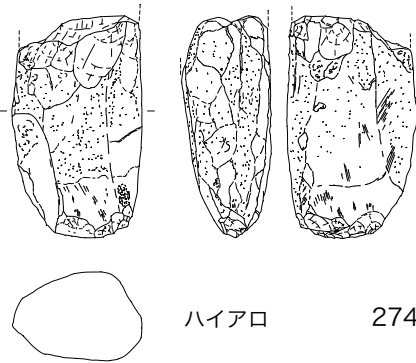

ハイアロ 274

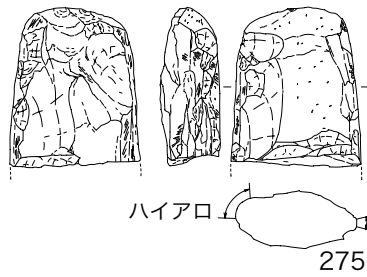

ハイアロ 275

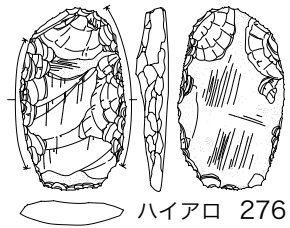

ハイアロ 276

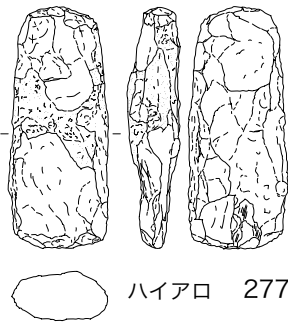

ハイアロ 277

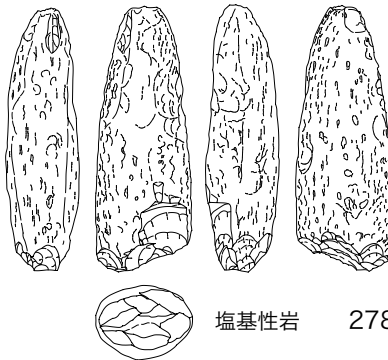

塩基性岩 278

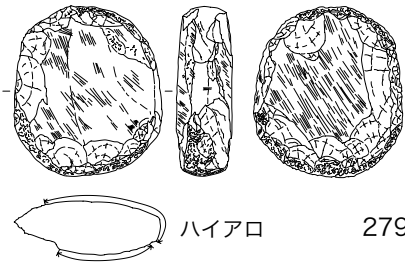

ハイアロ 279

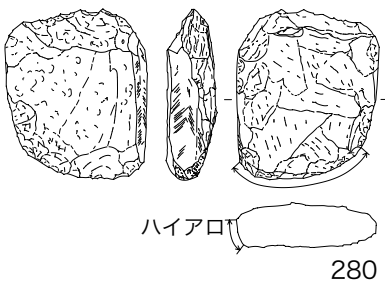

ハイアロ 280

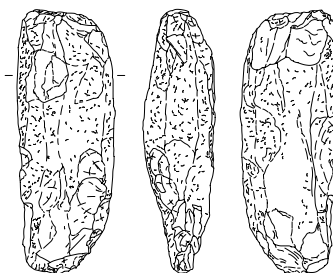

ハイアロ 281

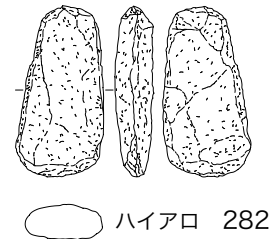

ハイアロ 282

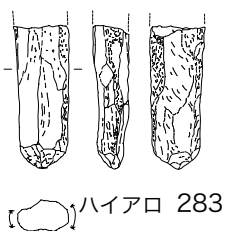

ハイアロ 283

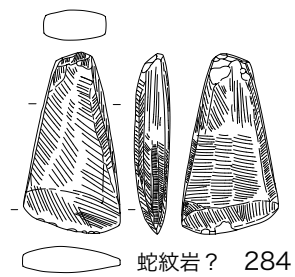

蛇紋岩? 284

※「ハイアロ」はハイアロクラスタイトのことを示す

S=1/3

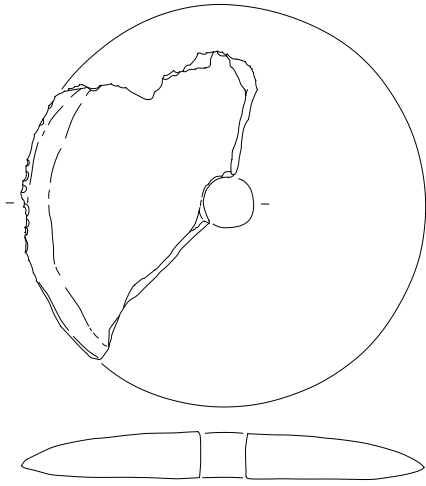

斑レイ岩 285

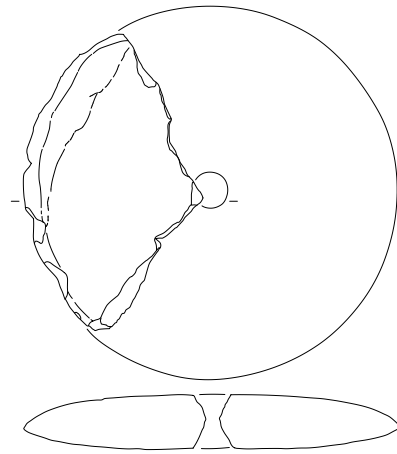

安山岩 286

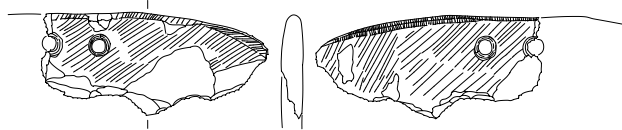

緑色片岩 288

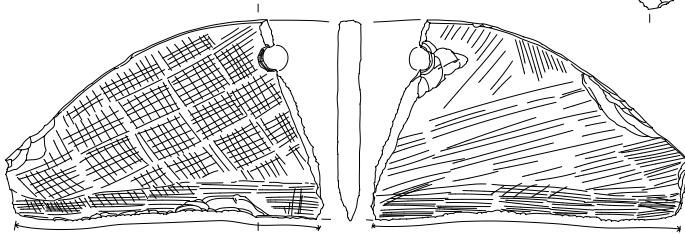

緑色片岩 287

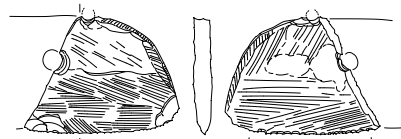

緑色片岩 289

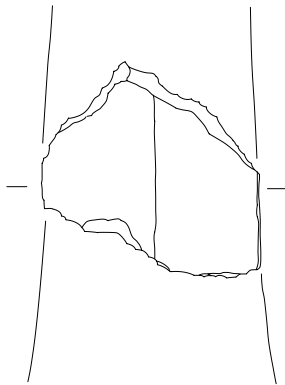

砂岩 290

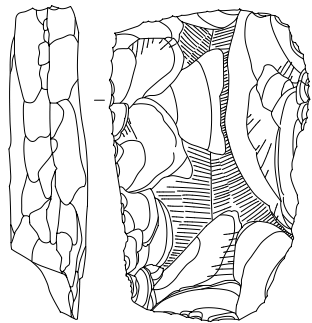

S=1/2

291

サヌカイト?

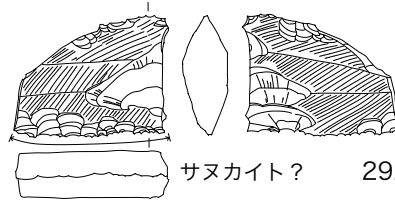
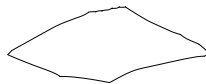

サヌカイト? 292

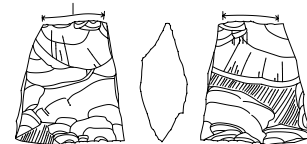

サヌカイト? 293

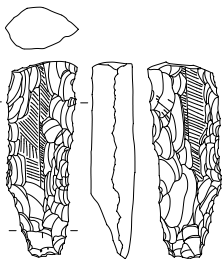

サヌカイト? 294

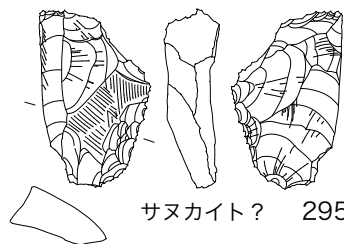

サヌカイト? 295

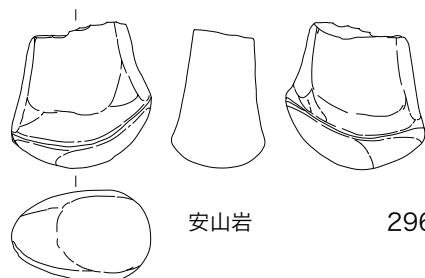

安山岩 296

S=1/3

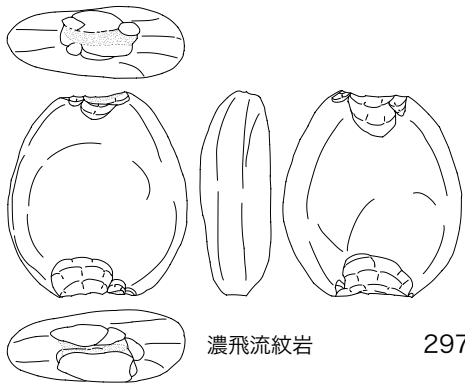

濃飛流紋岩 297

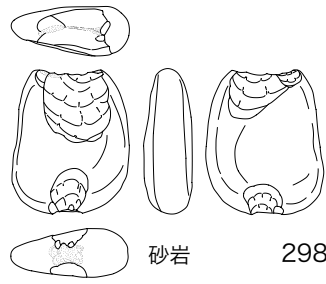

砂岩 298

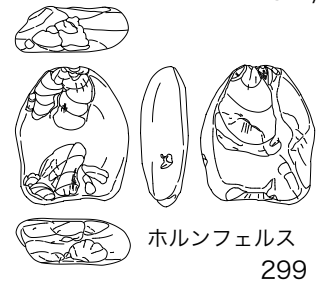

ホルンフェルス 299

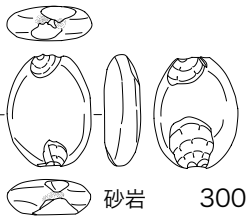

砂岩 300

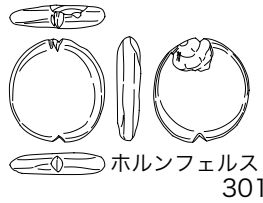

ホルンフェルス 301

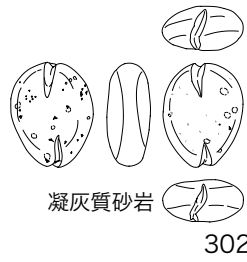

凝灰質砂岩 302

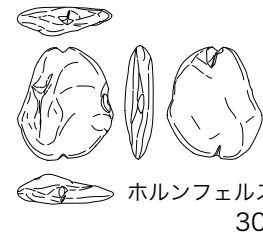

ホルンフェルス 303

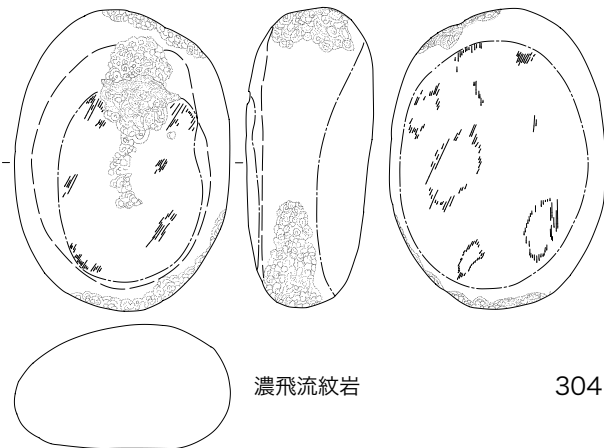

濃飛流紋岩 304

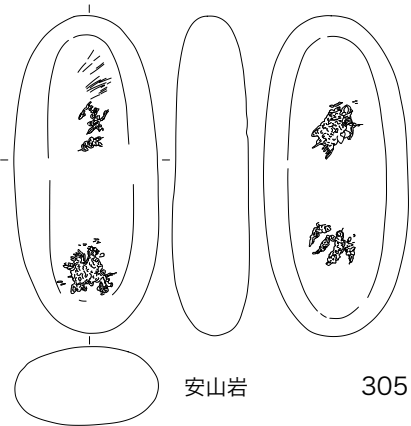

安山岩 305

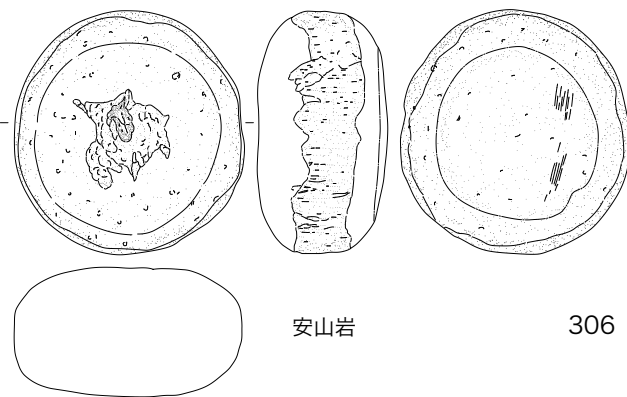

安山岩 306

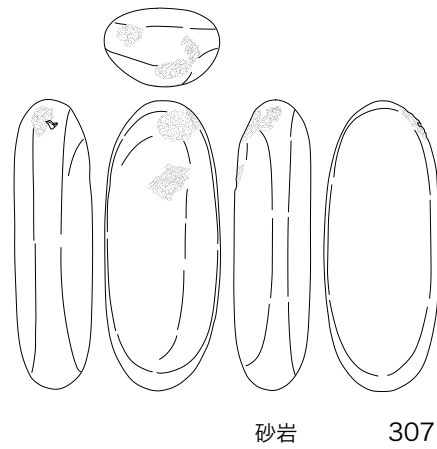

砂岩 307

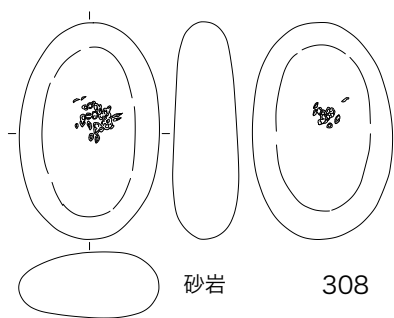

砂岩

308

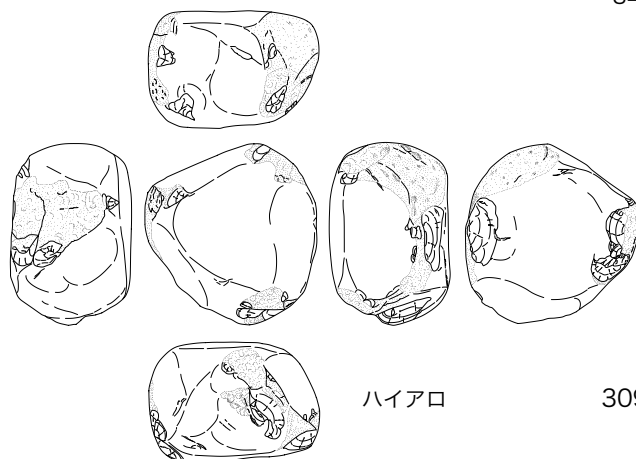

ハイアロ

309

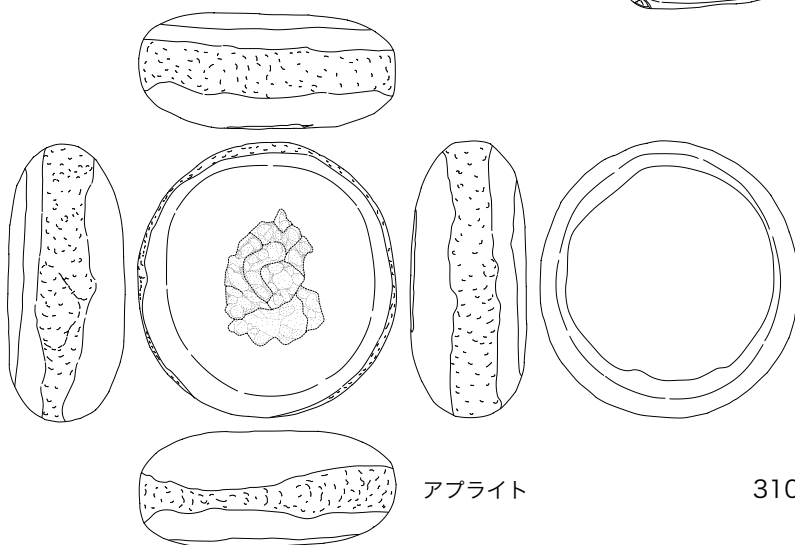

アプライト

310

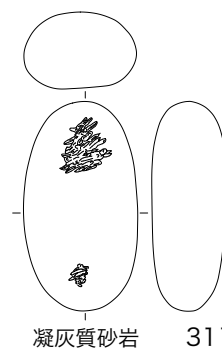

凝灰質砂岩

311

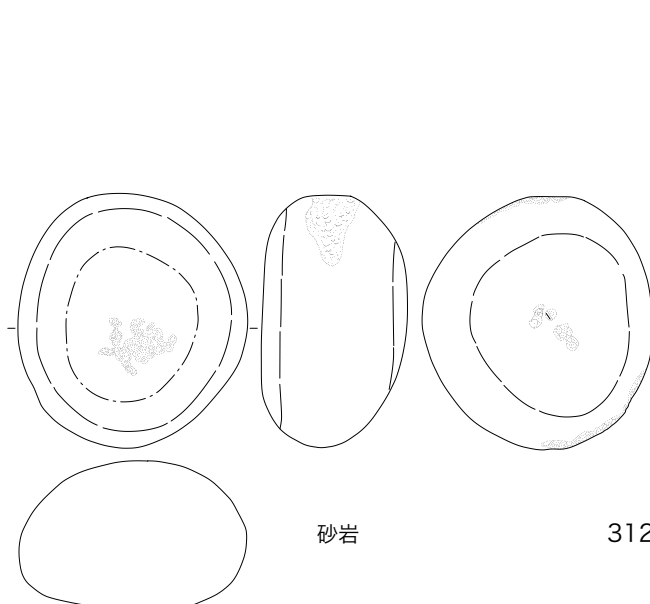

砂岩

312

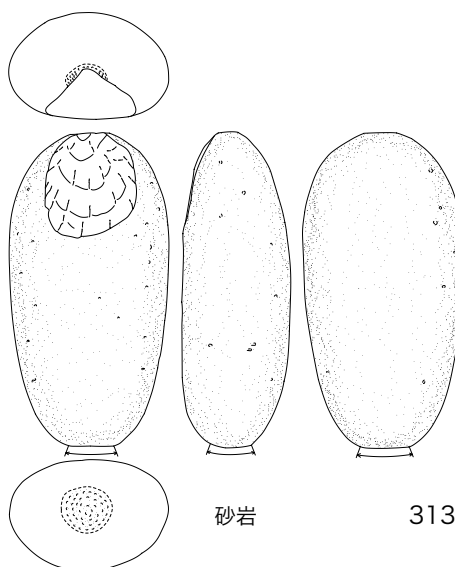

砂岩

313

※「ハイアロ」はハイアロクラスタイトのことを示す

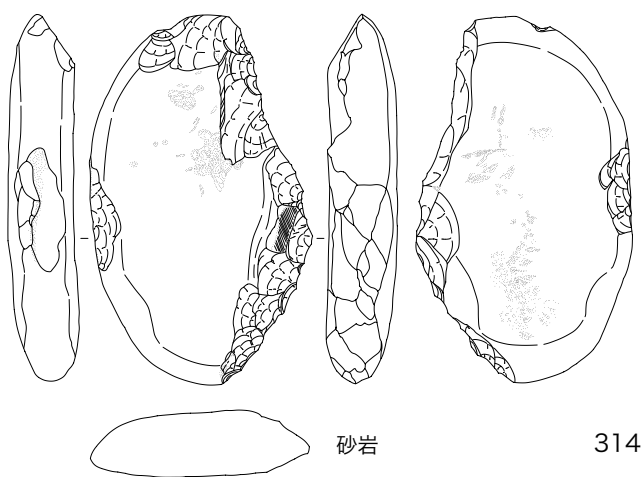

砂岩

314

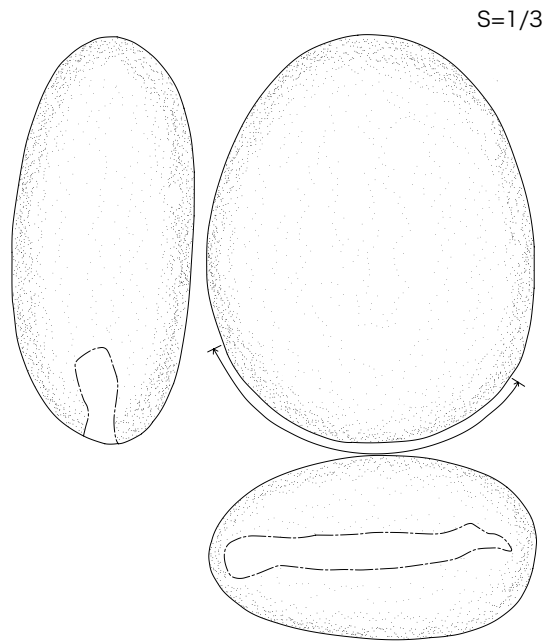

S=1/3

花崗岩

315

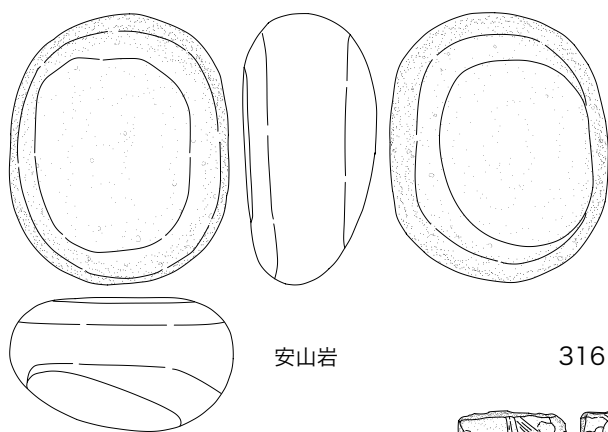

安山岩

316

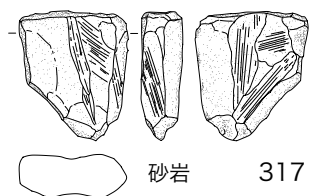

砂岩

317

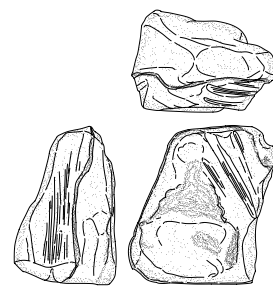

凝灰質砂岩

318

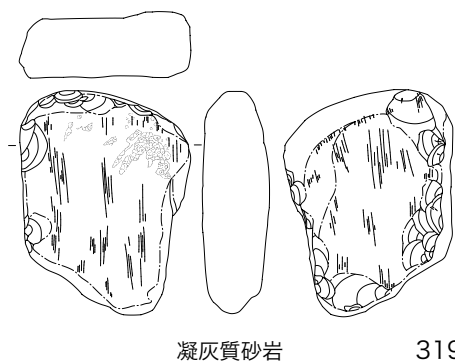

凝灰質砂岩

319

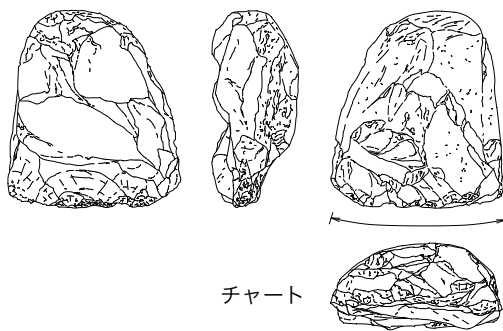

チャート

320

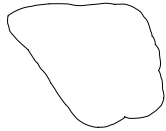
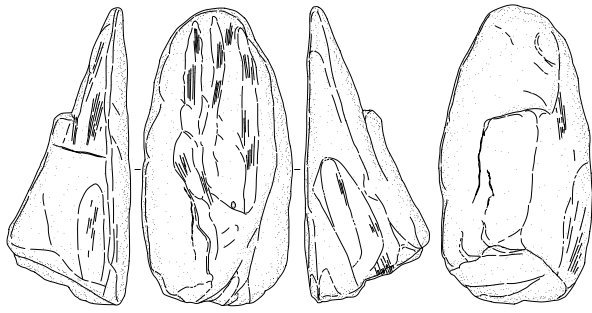

凝灰質砂岩 321

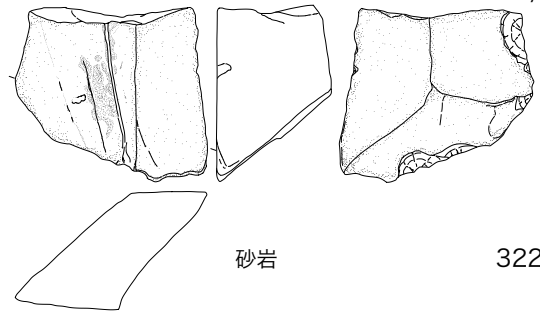

砂岩

322

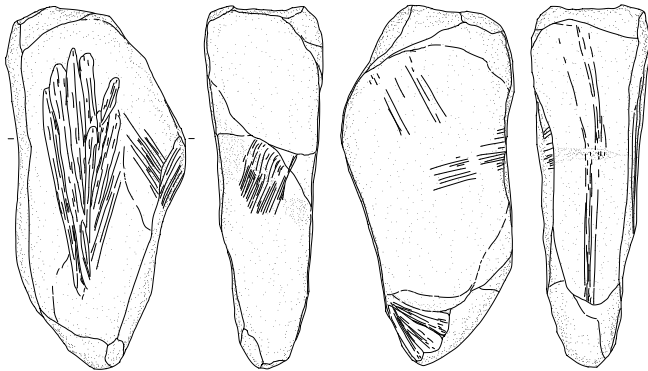

砂岩

323

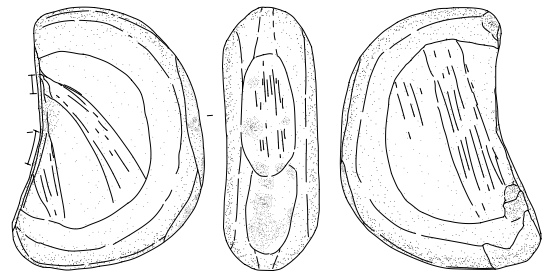

アプライト
or
ドロマイト

324

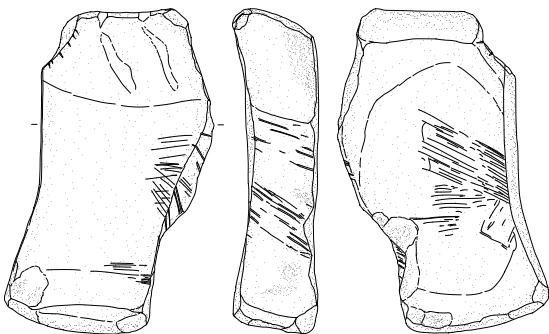

砂岩

325

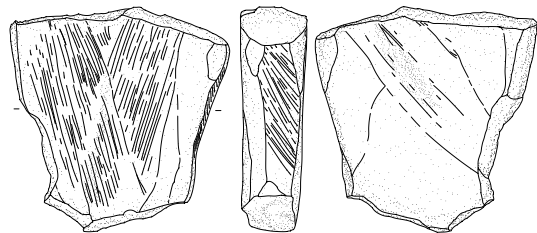

砂岩

326

S=1/4

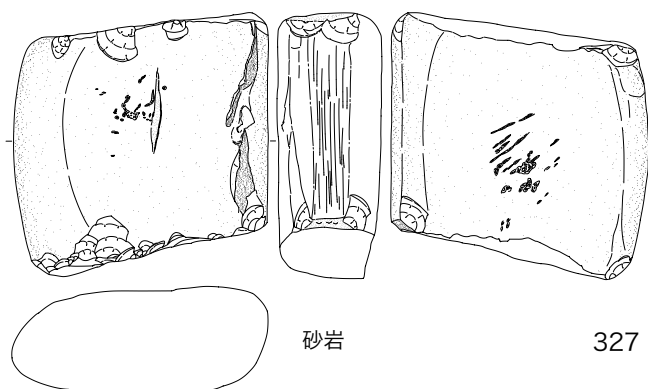

砂岩

327

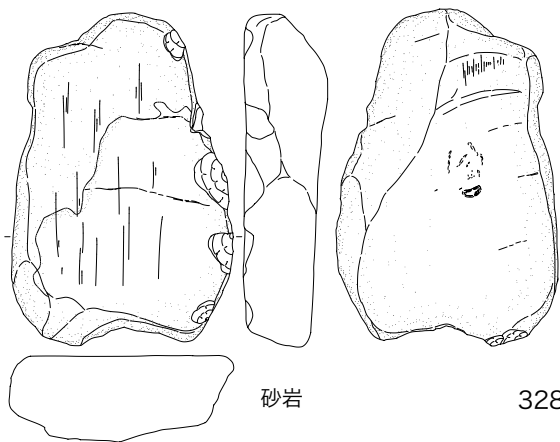
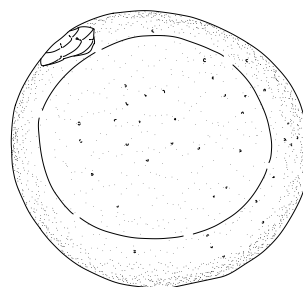

砂岩

328

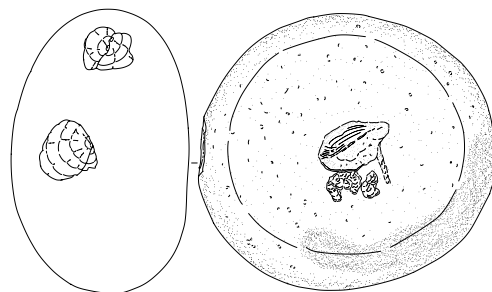

安山岩

329

S=2/3



330

331

332

333

330~333 : 熔結凝灰岩

S=1/2

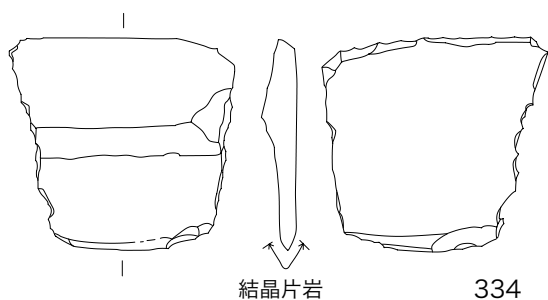

結晶片岩

334

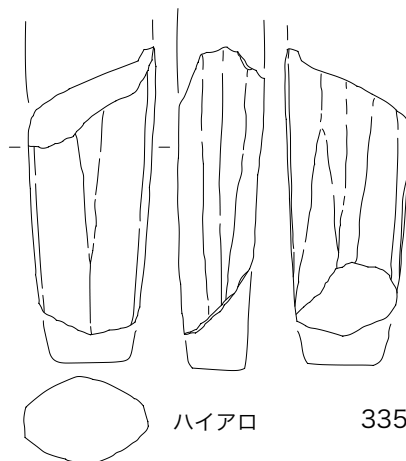

ハイアロ

335

※「ハイアロ」はハイアロクラスタイトのことを示す

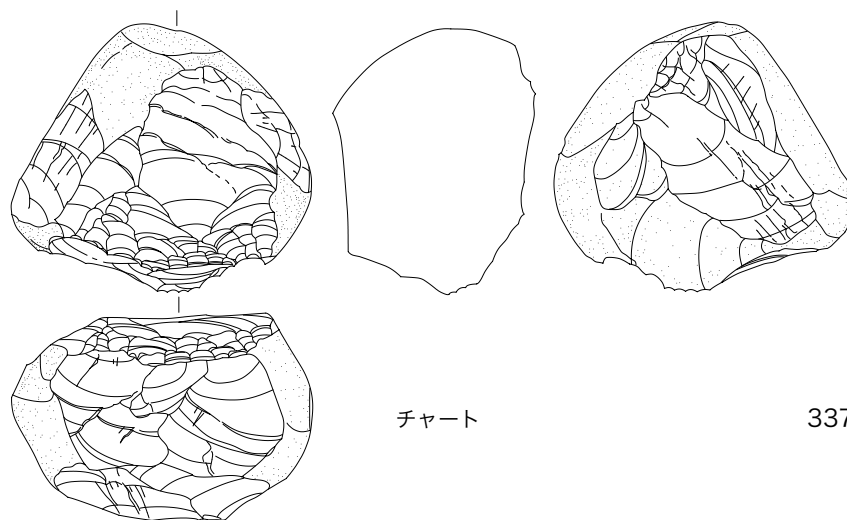
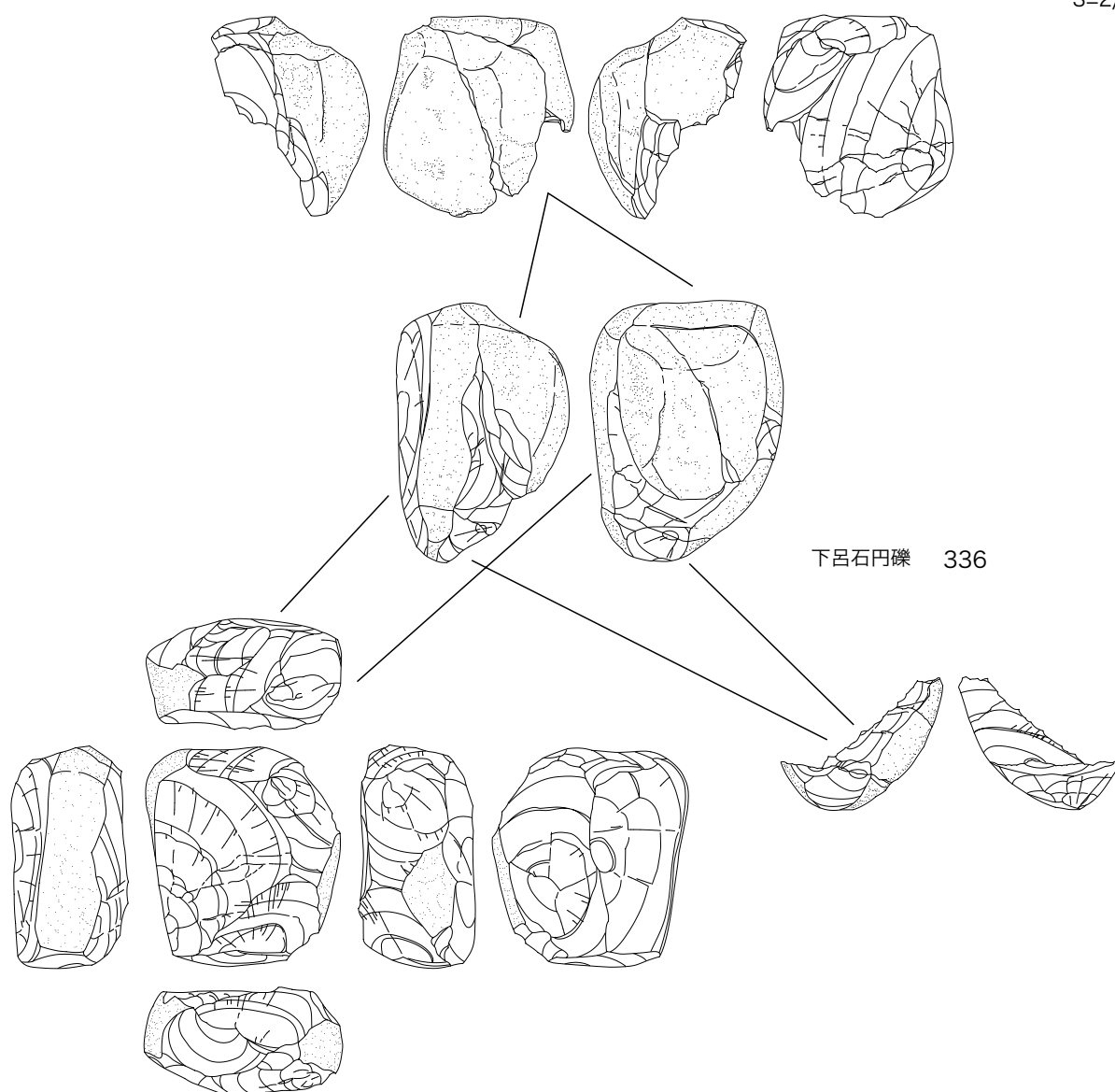

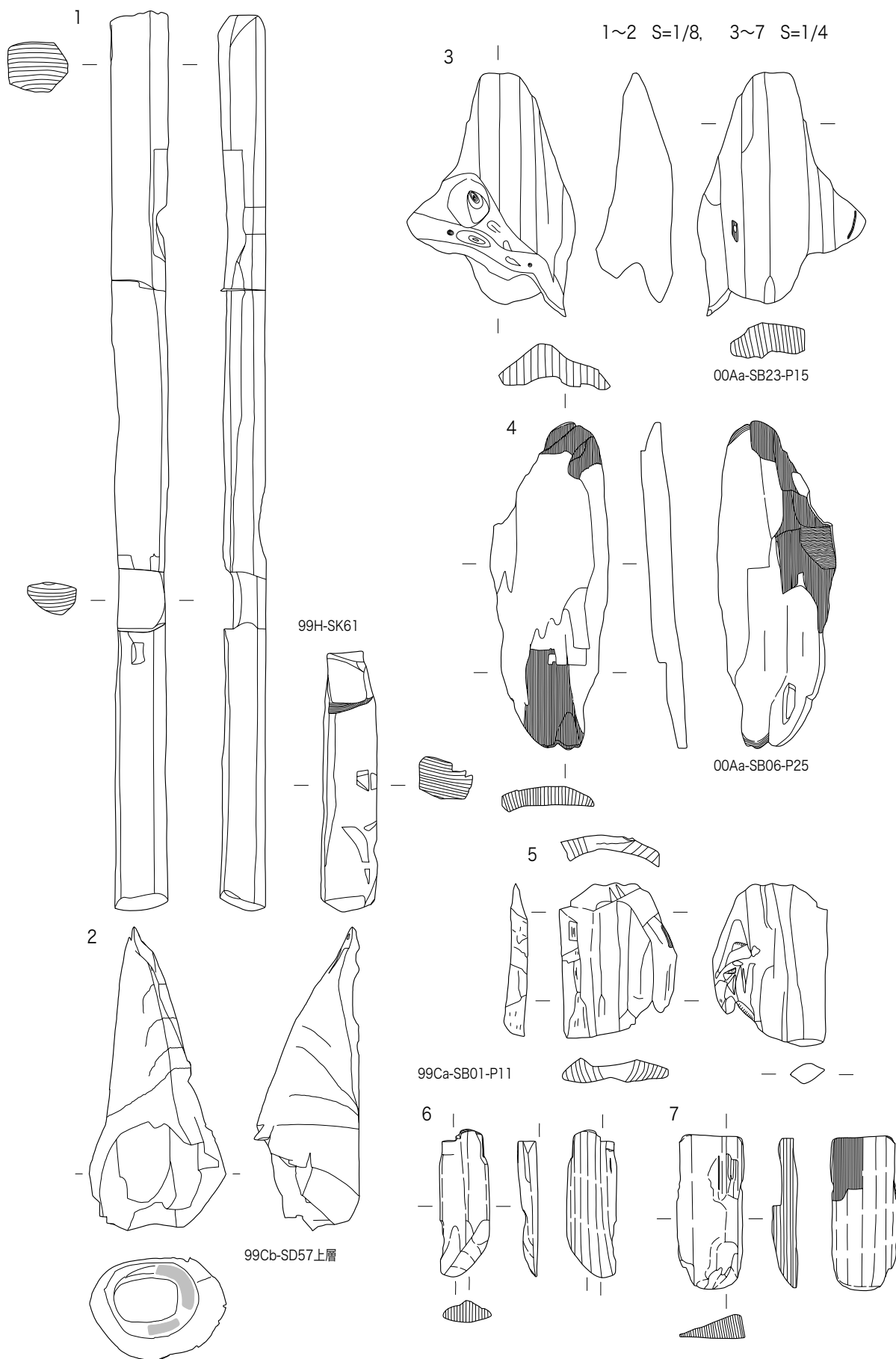

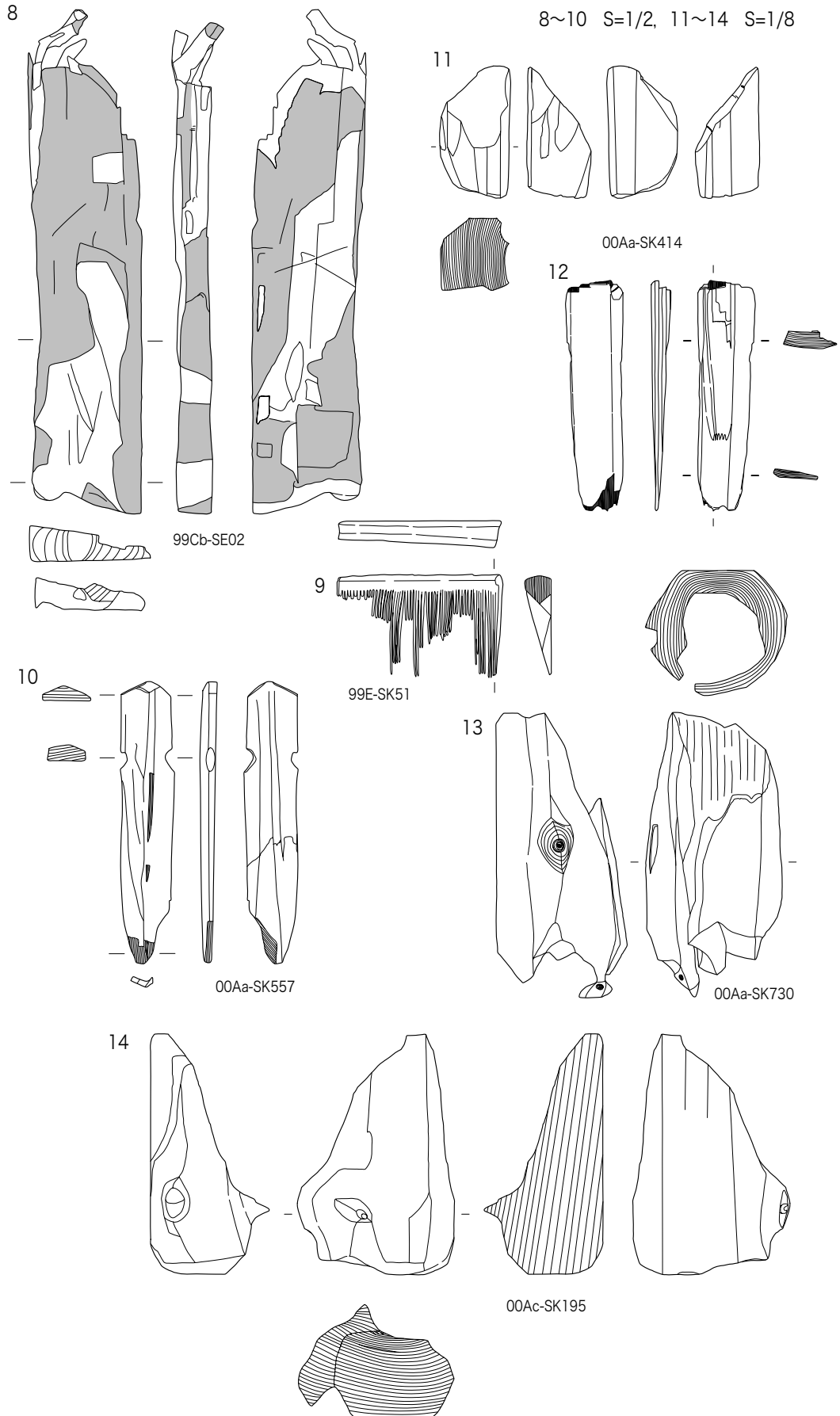

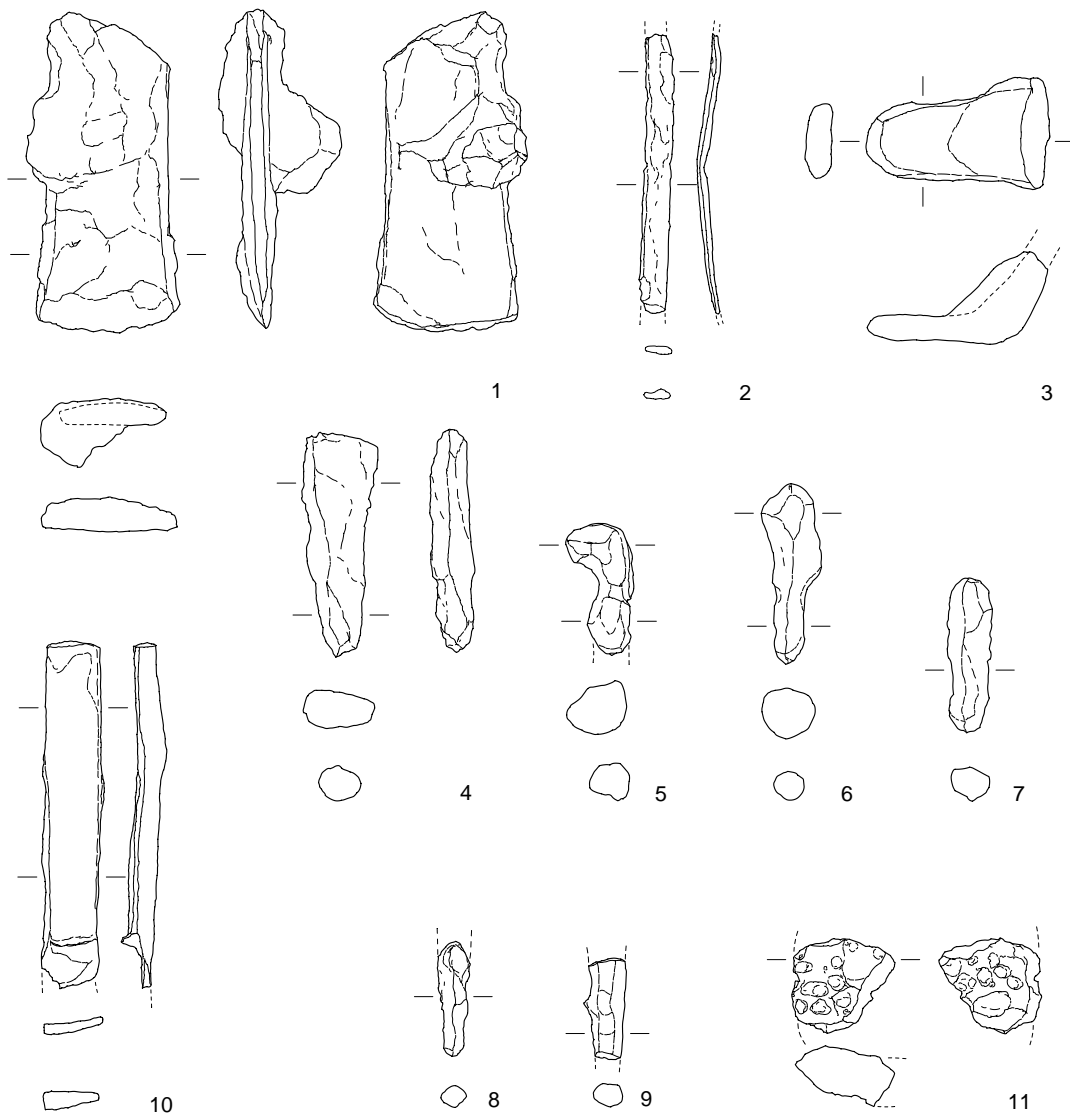

(実物大写真)



「皇宋通寶」

12

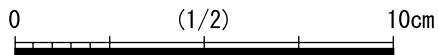



上 99A区全景(北東から)
下左 方形周溝墓SZ01(北西から)

下右上 東側遺構群(北から)
下右下 西側畦畔(北から)



上左 99I区全景(北東から)
中左 方形周溝墓SZ01(南東から)
下左 SD01・SD02土層断面

上右 99I区全景(南西から)
中右 SD07遺物出土状況
下右 SK02遺物出土状況



上 99B・Ca区全景（北東から）
下 99Cb区全景（南西から）



上 方形周溝墓 SZ05・環濠・SB01 (西から)
下 大型掘立柱建物 SB01 (西から)



上左 SB01 検出状況 (西から)
中左 SB01-P08 柱根出土状況 (南東から)
下左 SB01-P11 柱根出土状況 (北東から)

上右 SB01-P01 検出状況 (北から)
中右 SB01-P08 土層断面 (北から)
下右 SB01-P11 土層断面 (北から)



上 竪穴住居 SB02 (南東から)
中左 SB02 遺物出土状況 (南東から)
下左 SB02 土層断面 (南東から)

中右 ベンガラ・磨製石斧出土状況 (南西から)
下右 SB02 土層断面 (南西から)



上左 竪穴住居 SB03 (南東から)

中左 竪穴住居 SB04 (南東から)

下 竪穴住居 SB02・SB03・SB04・方形周溝墓 SZ05 (西から)

上右 SB03-SK01 炉断面 (北東から)

中右 竪穴住居 SB06 (東から)



上 方形周溝墓 SZ05 (南東から)

中左 SZ05 周溝 -SD01 土層断面 (東から)

下左 SZ05 主体部 SK42 土層断面 (南東から)

中右 SZ05 周溝 -SD03 土層断面 (南東から)

下右 SK42 弥生土器出土状況 (南東から)



上 方形周溝墓 SZ01 (北西から)
中左 SZ01・SK37 検出状況 (北東から)
下左 SZ01 主体部 -SK16 (南西から)

中右 SZ01 周溝 -SD03 土層断面 (南西から)
下右 墓壇 SK37 土層断面 (南東から)



上左 SZ04 周溝 -SD04 弥生土器出土状況 (南東から)

中左 方形周溝墓 SZ06 (東から)

下 方形周溝墓 SZ08 周溝 -SK34 弥生土器出土状況 (北から)

上右 SZ04 周溝 -SD04 弥生土器出土状況 (南西から)

中右 SZ06-SD02 弥生土器出土状況 (南から)



上左 墓壙 SK02 木棺プラン検出状況 (南東から)
中左 SK02 土層断面 (南東から)
下左 墓壙 SK13 木棺プラン検出状況 (北東から)

上右 SK02 土層断面 (南東から)
中右 SK02 土層断面 (北東から)
下右 SK13 土層断面 (東から)



上 墓壙 SK41・SK43 (南東から)
中左 SK41 遺物出土状況 (北西から)
下左 土坑 SK44 土層断面 (北から)

中右 SK43 土層断面 (北西から)
下右 土坑 SK80 遺物出土状況 (東から)



上左 土坑 SD45 (南西から)

中 弥生時代中期大溝 SD03・SD04 (北から)

下左 SD03・外環濠 SD17 交差部土層断面 (北から)

上右 SD45 弥生土器出土状況 (近景)

下右 SD03 土層断面 (南から)



上 外環濠 SD18 (写真手前左側が陸橋部)・内環濠 SD16 (北東から)
下 内環濠 SD16・外環濠 SD57 (写真手前右側が陸橋部) (南西から)



上 環濠 SD16・SD57 遺物出土状況(西から)
中左 SD16 上層玉原石半加工品出土状況(北から)

中右 SD16 内側土壘状遺構土層断面(南から)
下右 外環濠 SD18 土層断面(東から)



上左 弥生時代掘立柱建物 SB05 (北東から)
中 平安時代井戸 SE01 土層断面 (南から)
下左 SK29 灰釉系陶器出土状況 (南から)

上右 古代溝 SD08 鉄斧出土状況 (南から)
下右 P181 灰釉系陶器出土状況 (南から)

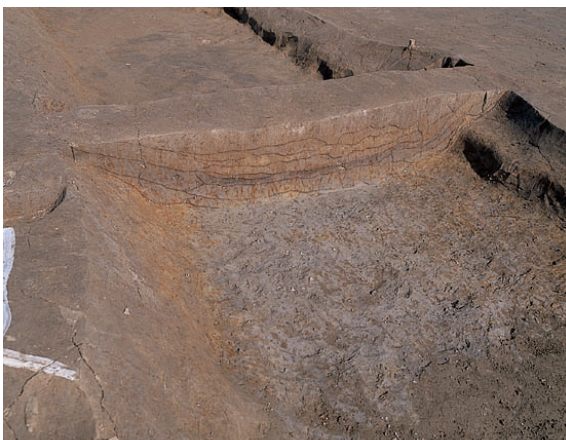

上 99D・E区全景 (北から)
中左 内環濠 SD01 土層断面
下左 外環濠 SD02 土層断面

中右 SD01 上層遺物出土状態 (西から)
下右 SD02 上層遺物出土状態 (西から)

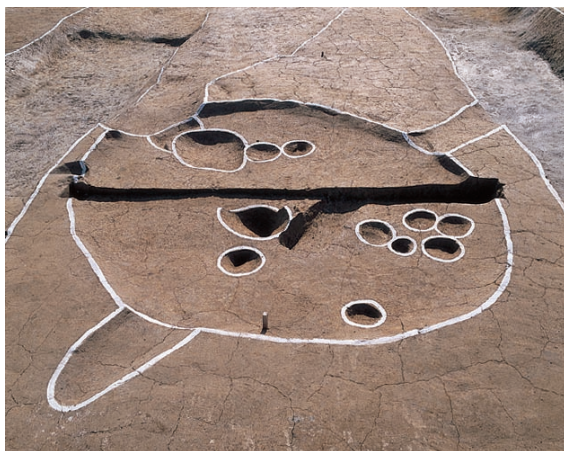

上左 SD04 完掘状況(東から)
中左 竪穴住居 SK95(北から)
下左 SK151(曲物出土状況)

上右 SD04 土層断面(東から)
中右 SK81 遺物出土状況(西から)
下右 99D区 SZ01 遺物出土状況

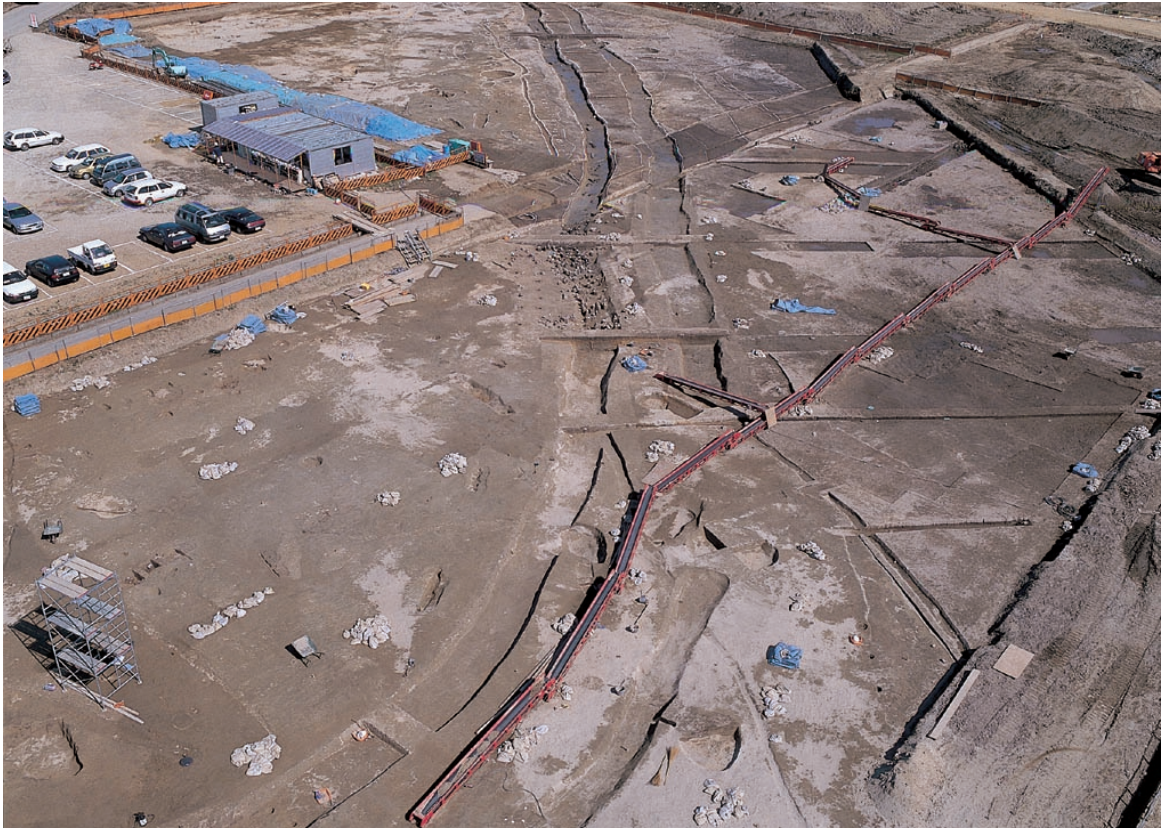

上 99H区・99Cb区(南西から)
下 99H区(北西から)



上 環濠 SD01・SD02 上層遺物出土状況 (南西から)

中左 内環濠 SD01 土層断面 (北から)

下左 SD01 下層弥生土器出土状況 (南から)

中右 外環濠 SD02 土層断面 (北から)

下右 SD01 上層遺物出土状況 (北東から)



上左 SD01 上層管玉出土状況(東から)
中 土製人面出土状況(西から)
下左 SD01 下層炭化米出土状況(南から)

上右 SD02 上層管玉出土状況(南から)
下右 SD01 上層弥生土器出土状況(南東から)



上左 竪穴住居 SK86 周辺遺構 (西から)
中 竪穴住居 SK86 (北西から)
下左 SK86 炉土層断面 (南西から)

上右 SK63 被熱粘土塊出土状況 (南東から)

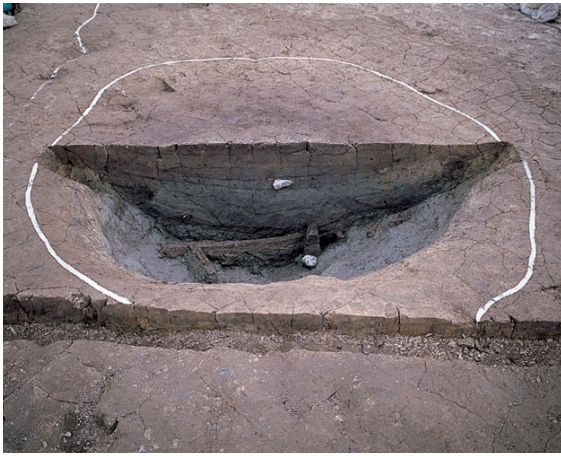

上左 SK37 弥生土器出土状況(東から)
中左 弥生時代土坑 SK61 土層断面(南西から)
下左 SK49 小型丸底壺出土状況(北から)

上右 弥生時代土坑 SK68 土層断面(南から)
中右 SK61 遺物出土状況(西から)
下右 SK117 灰釉陶器出土状況(南西から)



上左 99F区(南西から)

中 00B区(南西から)

下左 99F区自然流路NR01(北から)

上右 99G区(北東から)

下右 00B区自然流路NR01(南から)



上 SZ04-SD19 弥生土器出土状況(南から)
中左 方形周溝墓 SZ01 (南西から)

中右 方形周溝墓 SZ02 (南東から)
下右 方形周溝墓 SZ04 (南東から)



上 00Aa区全景 (北東から)

中左 00Aa区東側遺構群 (南西から)

下左 環濠 SD01・SD02 周辺 (南西から)

中右 竪穴住居 SB07・SB23 周辺 (東から)

下右 竪穴住居 SB06・SB08 周辺 (北東から)



上 竪穴住居 SB06 (東から)

中左 SB06-P27 土層断面 (南西から)

下左 P08 土層断面 (東から)

中右 SB06-P25 柱根出土状況 (北西から)

下中 P16 土層断面 (西から)

下右 P26 土層断面 (西から)



上 竪穴住居 SB07 (南西から)
中左 中央土坑 P20 土層断面 (東から)
下左 竪穴住居 SB09 (南西から)

中右 SB07 遺物出土状況 (南西から)
下右 竪穴住居 SB18 (南西から)



上左 竪穴住居 SB01 (南西から)
中 竪穴住居 SB16 (南西から)
下左 竪穴住居 SB08 (南西から)

上右 竪穴住居 SB02 (北西から)
下右 竪穴住居 SB23 (南東から)



上左 SD02・SD03 土層断面(南から)
中左 SD03 弥生土器出土状況(北から)
下左 土坑 SK716 遺物出土状況(北西から)

上右 大溝 SD04(南西から)
中右 SB20 弥生土器出土状況(北東から)
下右 土坑 SK426 遺物出土状況(北から)



上 SK126 遺物出土状況(北から)

中左 SK639 遺物出土状況(北西から) 中右 SK275 焼土出土状況(北から)

下左 SK162 土層断面(南西から)

下中 SK713 土層断面(南から)

下右 SB19・SK1043 土層断面(北東から)

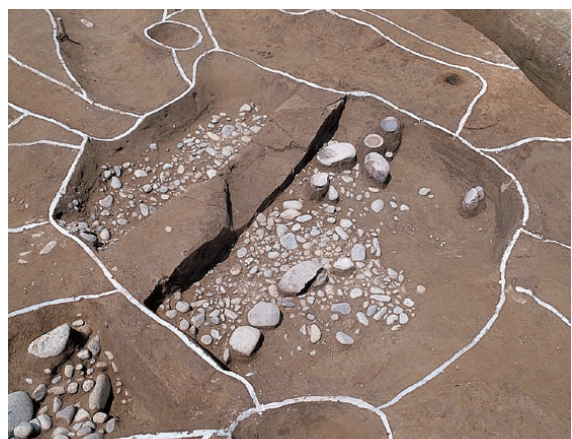

上左 平安時代掘立柱建物 SB101 (西から)

上右 掘立柱建物 SB103 (東から)

中左 SK730 柱根出土状況

中中 SK417 遺物出土状況 (南西から) 中右 SK402 土層断面 (南から)

下左 SK274 遺物出土状況 (東から)

下右 SK94 遺物出土状況 (南から)

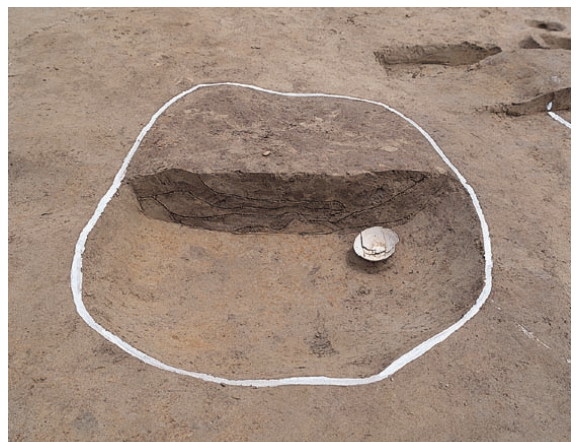

上 古代井戸 SK557 断割状況 (西から)

中左 SK557 遺物出土状況 (南東から)

下左 中世土坑 SK450・SK451 土層断面 (北東から)

中右 SK557 井戸枠出土状況 (南西から)

下右 中世土坑 SK145 土層断面 (南西から)



上 00Ab区全景(東から)

中左 竪穴住居SB01(北西から)

下左 SK213 弥生土器出土状況(北西から)

中右 SK101 弥生土器出土状況(南東から)

下右 SK264 沈線文系土器出土状況(西から)



上 弥生時代後期墳丘墓 SZ001・SZ002 (南西から)

中左 SZ001 (東から)

下左 SZ002 遺物出土土器出土状況 (南東から)

中右 SZ001 遺物出土状況 (北東から)

下右 SZ002 周溝 SD42 土層断面 (北東から)



上左 弥生時代後期竪穴住居 SB03 (東から)
中左 平安時代竪穴住居 SB06 (北から)
下左 中世方形区画溝 SD01 (南東から)

上右 SD45 遺物出土状況 (西から)
中右 古代溝 SD61 土層断面 (東から)
下右 SD01 土層断面 (北東から)



上 00Ac区西側(南東から)
下 00Ac区東側(南から)



上 環濠 SD01・SD02 (南東から)

中左 SD01 土層断面

下左 SD01 上層弥生土器出土状況 (東から)

中右 SD02 土層断面

下右 掘立柱建物と SK48・SK387 (南から)



上左 竪穴住居 SB03 (南西から)
中左 竪穴住居 SB06 (南から)
下左 竪穴住居 SB08・25・26 (西から)

上右 竪穴住居 SB04 (南西から)
中右 竪穴住居 SB09 (北西から)
下右 竪穴住居 SB16・33・34 他 (南西から)



上 竪穴住居 SB22・SB12 (北西から)
中左 SK250 弥生土器出土状況 (北東から)
下左 古墳時代井戸 SK160 土層断面 (南から)

中右 SK254・267 遺物出土状況 (北から)
下右 SK203 土器出土状況 (北西から)



上左 古代掘立柱建物 SB104・105 検出状況（北から）
中 SB108 柱穴 SK195 土層断面（東から）
下左 SB108 柱穴 SK243 須恵器出土状況（西から）

上右 古代掘立柱建物 SB108 検出状況（北から）
下右 古代竪穴住居 SK246（南東から）















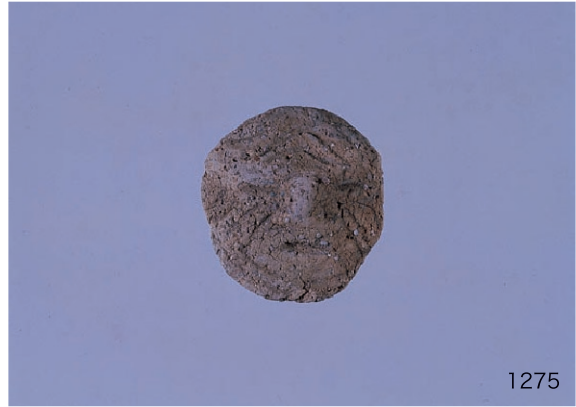



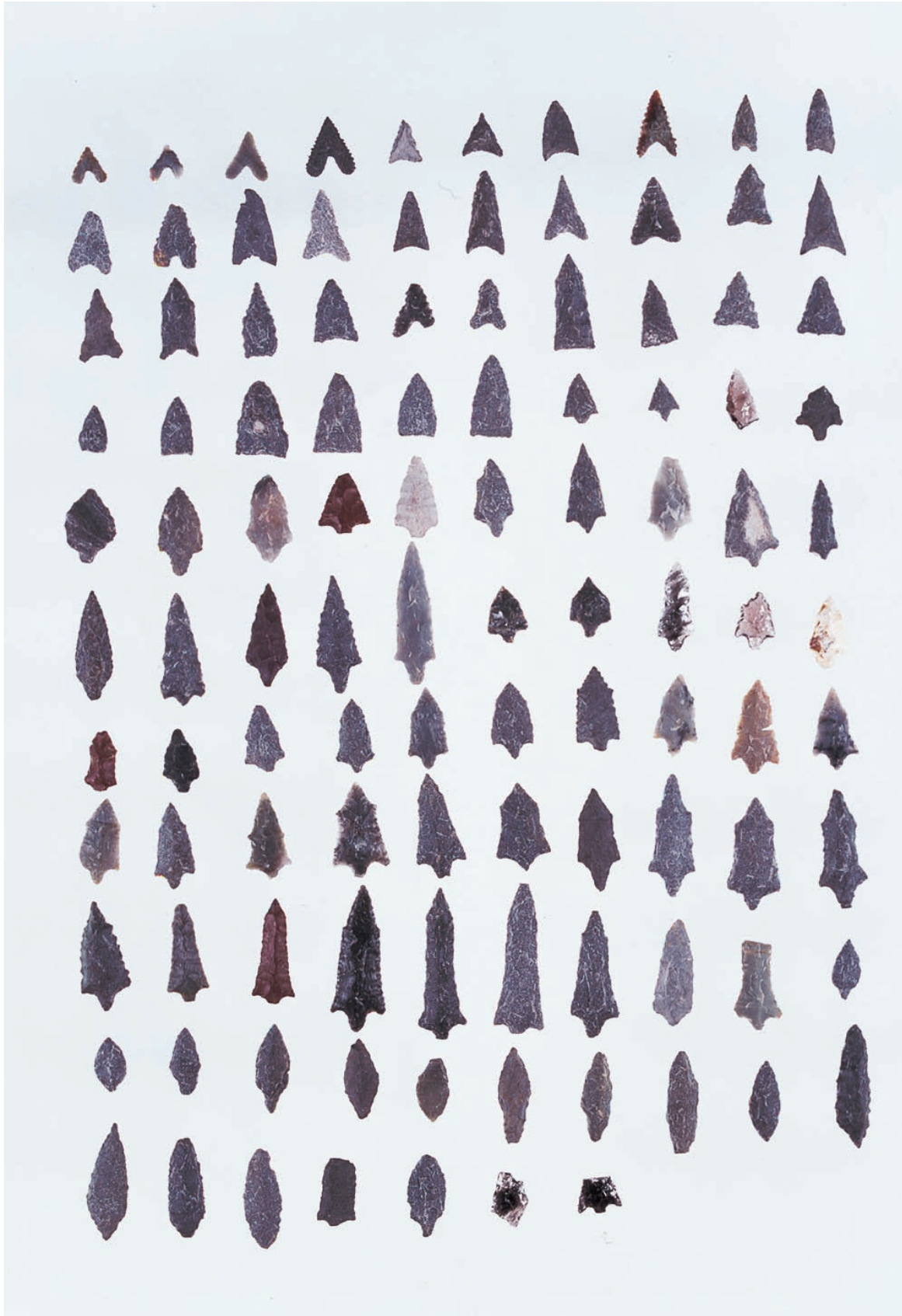

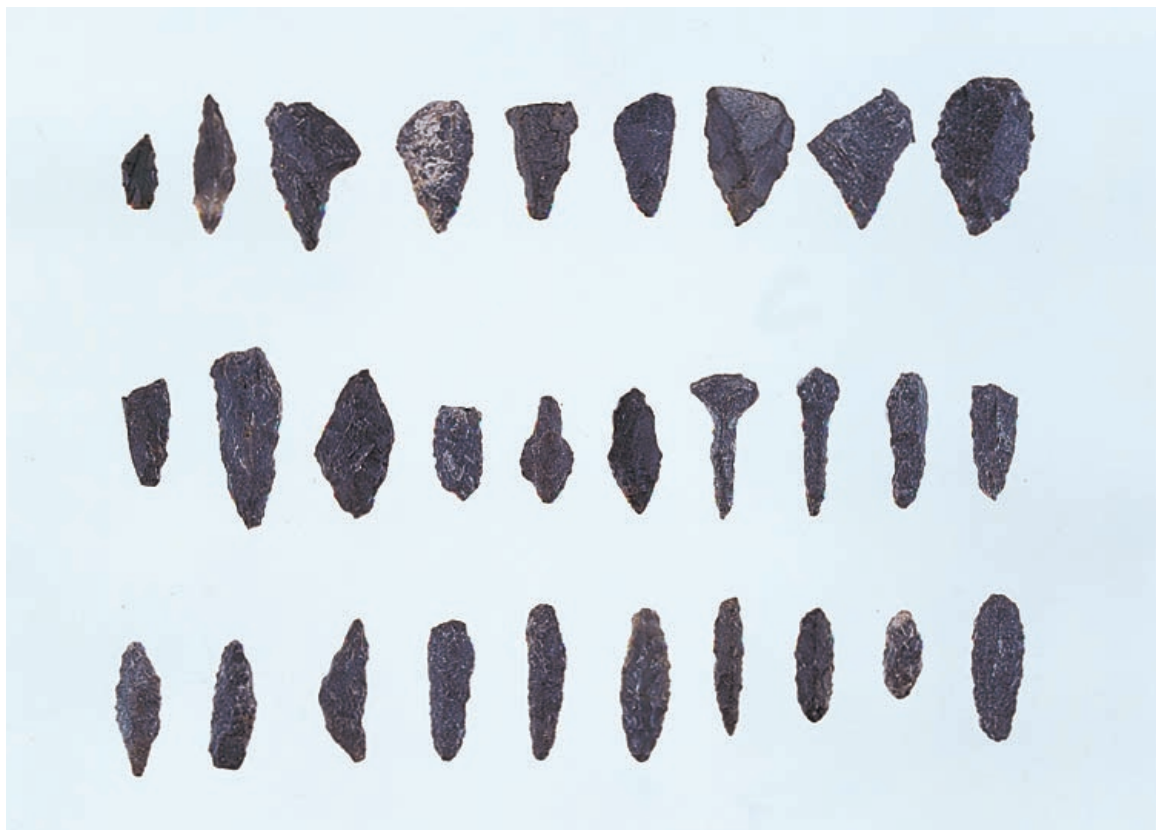

打製石錐



打製石斧



磨製石斧① 片刃石斧



磨製石斧② 両刃石斧



石包丁



管玉・玉関連石器



石小刀・石剣・石戈



石器原石(下呂石)